

DON-JO MFG., INC.

ARCHITECTURAL HARDWARE & ACCESSORIES



San Francisco, California

WRAP-AROUND PLATES

DON-JO MFG., INC.
P.O. Box 929
Sterling, MA 01564

PHONE: 978.422.3377
FAX: 978.422.3467
WATS: 800.628.8389
WATS FAX: 800.278.8202

WEB: www.don-jo.com
E-mail: info@don-jo.com
Section F, Version 1



INDEX

Item#	Page#	Item#	Page#	Item#	Page#	Item#	Page#
1-CW	1f	18-CW	6f	55A-CW	9f	258-CW	2f
2-CW	1f	19-CW	7f	55A-2-CW	9f	261-CW	2f
3-CW	1f	20-CW	4f	61-CW	1f	264-CW	2f
4-CW	1f	20-2-CW	4f	70-CW	3f	481-CW	2f
4-2-CW	4f	20B-CW	4f	71-CW	1f	484-CW	2f
4U-2-CW	8f	20C-CW	4f	75-CW	4f	486-CW	3f
5-CW	1f	20-FE	9f	80-CW	3f	504-CW	8f
5K-CW	4f	21-CW	7f	81-CW	1f	504-FE	10f
6-CW	1f	22-CW	7f	81-2-CW	4f	514-CW	8f
7-CW	1f	23-CW	7f	90-CW	3f	518-CW	6f
8-CW	1f	24-CW	7f	93-KV-CW	6f	942-CW	3f
9-CW	5f	25-CW	6f	95-CW	4f	943-CW	3f
9K-CW	4f	27-CW	5f	151-CW	2f	946-CW	3f
10-FE	9f	28-CW	5f	154-CW	2f	4000-2-CW	5f
12-CW	2f	30-CW	3f	200-CW	9f	4000-4-CW	5f
12-2-CW	2f	33-CW	9f	200C-CW	9f	4500-CW	8f
14-CW	7f	33A-CW	9f	212-CW	9f	4550-CW	8f
14-2-CW	7f	33A-2-CW	9f	212C-CW	9f	5000-CW	5f
15-CW	5f	40-CW	3f	214-CW	9f	5100-CW	6f
16-CW	6f	51-CW	1f	214C-CW	9f	E2000-CW	5f
17-CW	6f	55-CW	9f	256-CW	2f		

FASTENERS

Product	Fastening Type
All Wrap-Arounds	Trim Screws: 4 ea. #8 x 3/4" Phillips Truss Head Latch Screws: 2 ea. #8-32 x 1/4" Flat Head (per latch)
CW-504 & CW-514	Trim Screws: 2 ea. 1/4-20 x 3/4" MS Truss Head and 1/4-20 x 1 1/2" Sex Nut Latch Screws: #12-24 x 1/2" FHMS



CLASSIC WRAP-AROUNDS

For **CYLINDRICAL DOOR LOCKS** with 2 1/8" hole

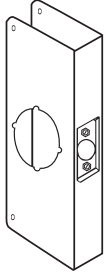

- 1-CW
- 2-CW
- 3-CW
- 4-CW

NUMBER	BACKSET	DOOR	DIMENSIONS
1-CW	2 3/8"	1 3/8"	4" x 9"
2-CW	2 3/8"	1 3/4"	4" x 9"
3-CW	2 3/4"	1 3/8"	4 1/4" x 9"
4-CW	2 3/4"	1 3/4"	4 1/4" x 9"

SHELF PACK: I

Box Size - 4 1/2" x 9 3/4"

GAUGE: 22 (.032)

CW comes box packaged as standard.

FINISHES: 10B (613), AB (609), BZ (612), PB (605), S (630)

Display Packaged also available. When ordering indicate by replacing the letters "CW" with "V" after the item number.

Display Package Size - 5 1/4" x 11"

For **DEADBOLTS** with 1 1/2" hole

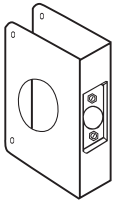

- 5-CW
- 6-CW
- 7-CW
- 8-CW

NUMBER	BACKSET	DOOR	DIMENSIONS
5-CW	2 3/8"	1 3/8"	4" x 4 1/2"
6-CW	2 3/8"	1 3/4"	4" x 4 1/2"
7-CW	2 3/4"	1 3/8"	4 1/4" x 4 1/2"
8-CW	2 3/4"	1 3/4"	4 1/4" x 4 1/2"

SHELF PACK: I

Box Size - 5 1/4" x 4 1/2"

GAUGE: 22 (.032)

CW comes box packaged as standard.

FINISHES: 10B (613), AB (609), BZ (612), PB (605), S (630)

Display Packaged also available. When ordering indicate by replacing the letters "CW" with "V" after the item number.

Display Package Size - 5 1/4" x 6 1/2"

For **CYLINDRICAL DOOR LOCKS** with 2 1/8" hole

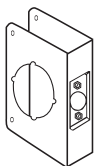

- 51-CW
- 61-CW
- 71-CW
- 81-CW

NUMBER	BACKSET	DOOR	DIMENSIONS
51-CW	2 3/8"	1 3/8"	4" x 4 1/2"
61-CW	2 3/8"	1 3/4"	4" x 4 1/2"
71-CW	2 3/4"	1 3/8"	4 1/4" x 4 1/2"
81-CW	2 3/4"	1 3/4"	4 1/4" x 4 1/2"

SHELF PACK: I

Box Size - 5 1/4" x 4 1/2"

GAUGE: 22 (.032)

CW comes box packaged as standard.

FINISHES: 10B (613), AB (609), BZ (612), PB (605), S (630)

Display Packaged also available. When ordering indicate by replacing the letters "CW" with "V" after the item number.

Display Package Size - 5 1/4" x 6 1/2"



For **DOUBLE LOCK COMBINATION LOCKSETS** with 1 1/2" hole on top and 2 1/8" hole on bottom with 4" centers

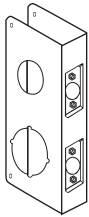

**154-CW
264-CW
484-CW**

NUMBER	BACKSET	DOOR	DIMENSIONS
154-CW	2 3/8"	1 3/8"	4" x 9"
264-CW	2 3/8"	1 3/4"	4" x 9"
484-CW	2 3/4"	1 3/4"	4 1/4" x 9"

SHELF PACK: 1 **Box Size - 4 1/2" x 9 3/4"**
GAUGE: 22 (.032) **CW comes box packaged as standard.**
FINISHES: IOB (613), AB (609), BZ (612), PB (605), S (630)

Display Packaged also available. When ordering indicate by replacing the letters "CW" with "V" after the item number.

Display Package Size - 5 1/4" x 11"

For **DOUBLE LOCK COMBINATION LOCKSETS** with 2 1/8" holes with 5 1/2" centers

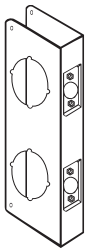

**256-CW
258-CW**

NUMBER	BACKSET	DOOR	DIMENSIONS
256-CW	2 3/8"	1 3/4"	4" x 12"
258-CW	2 3/4"	1 3/4"	4 1/4" x 12"

SHELF PACK: 1 **Box Pack**
GAUGE: 22 (.032)
FINISHES: IOB (613), AB (609), BZ (612), PB (605), S (630)

For **CYLINDER DOOR LOCKS** with 2 1/8" hole, 12" height

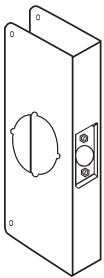

12-CW

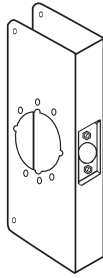

12-2-CW

NUMBER	BACKSET	DOOR	DIMENSIONS
12-CW	2 3/4"	1 3/4"	4 1/4" x 12"
12-2-CW	2 3/4"	1 3/4"	4 3/4" x 12"

SHELF PACK: 1 **Box Pack**
GAUGE: 22 (.032)
FINISHES: IOB (613), PB (605), S (630)

For **DOUBLE LOCK COMBINATION LOCKSETS** with 2 1/8" holes with 3 5/8" centers

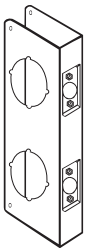

**151-CW
261-CW
481-CW**

NUMBER	BACKSET	DOOR	DIMENSIONS
151-CW	2 3/8"	1 3/8"	4" x 9"
261-CW	2 3/8"	1 3/4"	4" x 9"
481-CW	2 3/4"	1 3/4"	4 1/4" x 9"

SHELF PACK: 1 **Box Size - 4 1/2" x 9 3/4"**
GAUGE: 22 (.032) **CW comes box packaged as standard.**
FINISHES: IOB (613), AB (609), BZ (612), PB (605), S (630)

Display Packaged also available. When ordering indicate by replacing the letters "CW" with "V" after the item number.

Display Package Size - 5 1/4" x 11"



For **DOUBLE LOCK COMBINATION LOCKSETS** with 2 1/8" holes with 4" centers

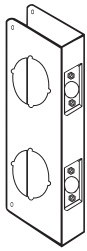

942-CW
943-CW

NUMBER	BACKSET	DOOR	DIMENSIONS
942-CW	2 3/8"	1 3/4"	4" x 9"
943-CW	2 3/4"	1 3/4"	4 1/4" x 9"

SHELF PACK: I **Box Size - 4 1/2" x 9 3/4"**
GAUGE: 22 (.032) **CW comes box packaged as standard.**
FINISHES: IOB (613), AB (609), BZ (612), PB (605), S (630)

Display Packaged also available. When ordering indicate by replacing the letters "CW" with "V" after the item number.

Display Package Size - 5 1/4" x 11"

For **DOUBLE LOCK COMBINATION LOCKSETS** with 6" centers

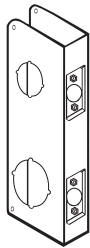

486-CW
hole sizes
1 1/2" over 2 1/8"

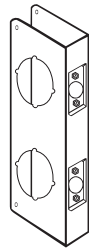

946-CW
hole sizes
2 1/8" over 2 1/8"

NUMBER	BACKSET	DOOR	DIMENSIONS
486-CW	2 3/4"	1 3/4"	4 1/2" x 12"
946-CW	2 3/4"	1 3/4"	4 1/2" x 12"

SHELF PACK: I **Box Pack**
GAUGE: 22 (.032)
FINISHES: IOB (613), PB (605), S (630)

BLANK WRAP-AROUND with TRIM SCREWS



30-CW
40-CW
70-CW
80-CW
90-CW

NUMBER	DOOR	DIMENSIONS
30-CW	1 3/8"	4 1/4" x 9"
40-CW	1 3/4"	4 1/4" x 9"
70-CW	1 3/8"	4 1/4" x 4 1/2"
80-CW	1 3/4"	4 1/4" x 4 1/2"
90-CW	1 3/4"	5" x 12"

Display Packaged also available. When ordering indicate by replacing the letters "CW" with "V" after the item number.

Display Package Size - 5 1/4" x 11" and 5 1/4" x 6 1/2"

SHELF PACK: I **Box Size - 5 1/4" x 4 1/2" and 4 1/2" x 9 3/4"**
GAUGE: 22 (.032) **CW comes box packaged as standard.**
90-CW Box Pack Only
FINISHES: IOB (613), AB (609), BZ (612), PB (605), S (630)

20" WRAP-AROUND

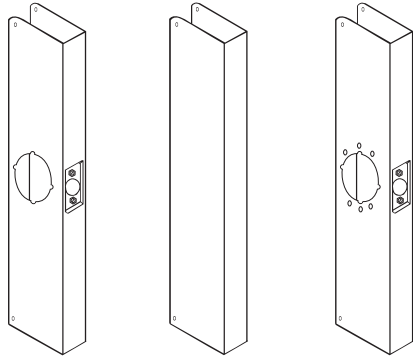

20-CW 20B-CW 20-2-CW

NUMBER	BACKSET	DOOR	DIMENSIONS
20-CW	2 3/4"	1 3/4"	5" x 20"
20B-CW	—	1 3/4"	5" x 20"
20C-CW	2 3/8"	1 3/4"	5" x 20"
20-2-CW	2 3/4"	1 3/4"	5 3/4" x 20"

SHELF PACK: 1 Box Pack
 GAUGE: 22 (.032)
 FEATURES: • Beveled front
 • Non-handed
 FINISHES: 10B (613), PB (605), S (630)

For installing the MARKS LEVERS

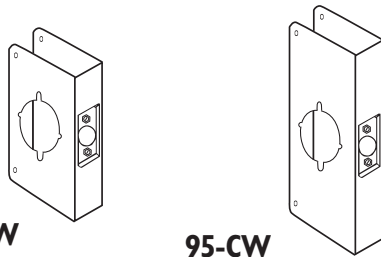

75-CW 95-CW

NUMBER	BACKSET	DOOR	DIMENSIONS
75-CW	2 3/4"	1 3/4"	4 3/4" x 5 1/2"
95-CW	2 3/4"	1 3/4"	4 3/4" x 9"

SHELF PACK: 1 Box Pack
 GAUGE: 22 (.032)
 FINISHES: 10B (613), AB (609), BZ (612), PB (605), S (630)

For installing the BEST AND SARGENT LEVER LOCKS

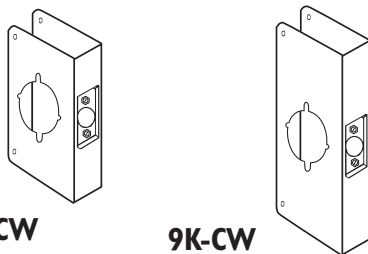

5K-CW 9K-CW

NUMBER	BACKSET	DOOR	DIMENSIONS
5K-CW	2 3/4"	1 3/4"	4 3/4" x 5 1/2"
9K-CW	2 3/4"	1 3/4"	4 3/4" x 9"

SHELF PACK: 1 Box Pack
 GAUGE: 22 (.032)
 FINISHES: 10B (613), AB (609), BZ (612), PB (605), S (630)

For use with HEAVY DUTY GRADE 1 & GRADE 2 key-in-levers

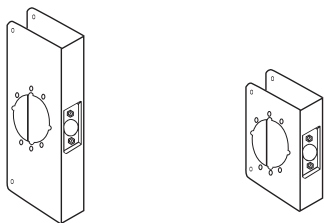

4-2-CW 81-2-CW

NUMBER	BACKSET	DOOR	DIMENSIONS
4-2-CW	2 3/4"	1 3/4"	4 3/4" x 9"
81-2-CW	2 3/4"	1 3/4"	4 3/4" x 4 1/2"

SHELF PACK: 1 Box Pack
 GAUGE: 22 (.032)
 FEATURES: Works with Schlage, Arrow, Yale, Sargent, Corbin Russwin and Falcon T
 FINISHES: 10B (613), AB (609), BZ (612), PB (605), S (630)



For **KABA/SIMPLEX 1000, E-2000, 4000 & 5000 SERIES**

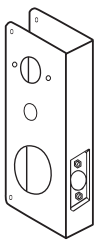

9-CW

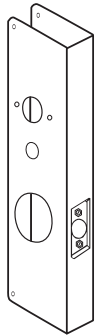

15-CW

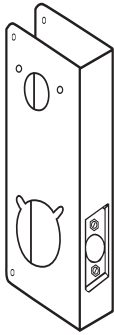

4000-CW

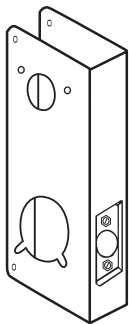

5000-CW

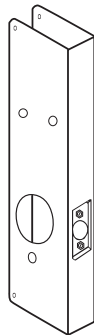

E-2000-CW

NUMBER	BACKSET	DOOR	DIMENSIONS
9-CW	2 3/4"	1 3/4"	5" x 9"
15-CW	2 3/4"	1 3/4"	5" x 15"
4000-2-CW	2 3/8"	1 3/4"	5" x 15"
4000-4-CW	2 3/4"	1 3/4"	5" x 15"
5000-CW	2 3/4"	1 3/4"	5" x 15"
E2000-CW	2 3/4"	1 3/4"	5" x 15"

SHELF PACK: 1

Box Pack

GAUGE: 22 (.032)

FEATURES: (9-CW & 15-CW) Works with Simplex 1000 Lock
 (E2000-CW) Works with Simplex E-2000 Lock
 (4000-CW) Works with Simplex 4000 Lock
 (5000-CW) Works with Simplex 5000 Lock

FINISHES: (9-CW, 15-CW, 4000-2-CW, 4000-4-CW) IOB (613), AB (609), PB (605), S (630)
 (5000-CW) IOB (613), PB (605), S (630)
 (E2000-CW) IOB (613), PB (605), S (630)

For **ALARM LOCK 2700/T2, 3000 & DL 4100 SERIES TRILOGY LOCK**

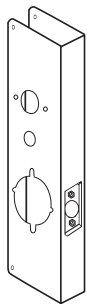

27-CW

NUMBER	BACKSET	DOOR	DIMENSIONS
27-CW	2 3/4"	1 3/4"	5" x 15"

SHELF PACK: 1

Box Pack

GAUGE: 22 (.032)

FINISHES: (27-CW) IOB (613), AB (609), PB (605), S (630)

For **SECURITRON SABLE LOCK**

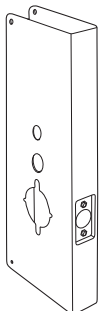

28-CW

NUMBER	BACKSET	DOOR	DIMENSIONS
28-CW	2 3/4"	1 3/4"	5" x 15"

SHELF PACK: 1

Box Pack

GAUGE: 22 (.032)

FEATURES: Works with Securitron Sable Lock

FINISHES: (28-CW) IOB (613), PB (605), S (630)



For **BEST 93-KV LOCKS & MAS-HAMILTON POWER LEVERS**

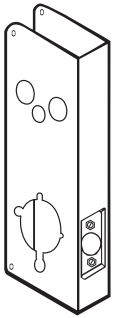

93-KV-CW

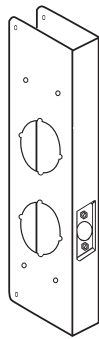

16-CW

NUMBER	BACKSET	DOOR	DIMENSIONS
93-KV-CW	2 3/4"	1 3/4"	5 1/2" x 12 3/4"
16-CW	2 3/4"	1 3/4"	5" x 15"

SHELF PACK: I Box Pack
 GAUGE: 22 (.032)
 FINISHES: 10B (613), PB (605), S (630)

For **ARROW REVOLUTION AND YALE IN TOUCH LOCKS**

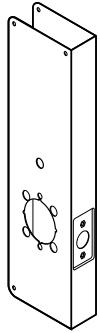

25-CW

NUMBER	BACKSET	DOOR	DIMENSIONS
25-CW	2 3/4"	1 3/4"	5 1/8" x 15"

SHELF PACK: I Box Pack
 GAUGE: 22 (.032)
 FINISHES: 10B (613), PB (605), S (630)

For **SCHLAGE COBRA LOCKS**

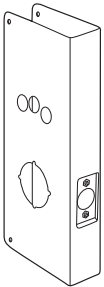

17-CW

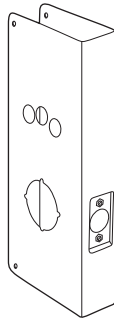

18-CW

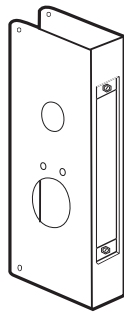

518-CW

NUMBER	BACKSET	DOOR	DIMENSIONS
17-CW	2 3/4"	1 3/4"	5" x 12"
18-CW	2 3/4"	1 3/4"	5" x 15"
518-CW	2 3/4"	1 3/4"	5" x 12"

SHELF PACK: I Box Pack
 GAUGE: 22 (.032)
 FEATURES: Works with Schlage King Cobra Cylindrical and Mortise Lock
 FINISHES: (17-CW, 18-CW) 10B (613), BZ (612), PB (605), S (630)
 (518-CW) 10B (613), PB (605), S (630)

For **SCHLAGE PRO SERIES**

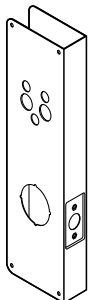

5100-CW

NUMBER	BACKSET	DOOR	DIMENSIONS
5100-CW	2 3/4"	1 3/4"	5 1/8" x 15"

SHELF PACK: I Box Pack
 GAUGE: 22 (.032)
 FEATURES: Works with Schlage/Locknetics pro series
 FINISHES: 10B (613), PB (605), S (630)



MORTISE LOCK wrap-around plate for 86 cut-out

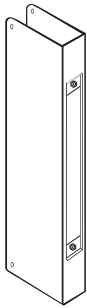

504-CW

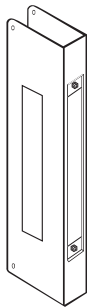

514-CW

NUMBER	BACKSET	DOOR	DIMENSIONS
504-CW	—	1 3/4"	5" x 12"
514-CW	2 3/4"	1 3/4"	5" x 12"

SHELF PACK: 1 Box Pack
 GAUGE: 22 (.032)
 FEATURES: • 8" x 1 1/4" Recess
 • Drill spindle and thumb turn holes in field
 • Rectangle size 1 5/8" x 7 5/16"
 • 8" x 1 1/4" Recess
 FINISHES: 10B (613), BZ (612), PB (605), S (630)

For CONVERTING UNIT LOCKS to LEVER LOCKS

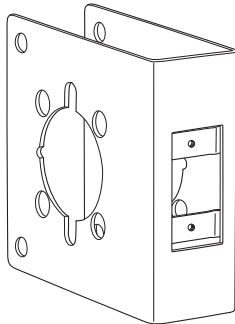

NUMBER	BACKSET	DOOR	DIMENSIONS
4U-2-CW	2 3/4"	1 3/4"	4 1/2" x 5"

SHELF PACK: 1 Box Pack
 GAUGE: 13 (.095) heavy gauge material
 FEATURES: • Converts unit locks to lever locks
 • Prepped to accept grade 1 & 2 levers
 • Sex bolts used to secure plate to door
 FINISHES: BP, DU, S

For MOUNTING DON-JO HOSPITAL PUSH/PULL LATCHES

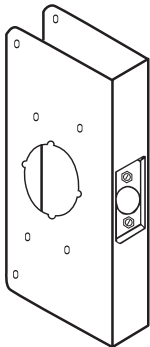

4500-CW
4550-CW

NUMBER	BACKSET	DOOR	DIMENSIONS
4500-CW	2 3/4"	1 3/4"	4 3/4" x 9"
4550-CW	5"	1 3/4"	6 1/2" x 9"

SHELF PACK: 1 Box Pack
 GAUGE: 22 (.032)
 FEATURES: Also works with ABH 6100 Series, Glenn Johnson HL6 & Hager 311
 FINISHES: 10B (613), PB (605), S (630)



For LOCKS with EXTENDED or CONVERTED BACKSETS

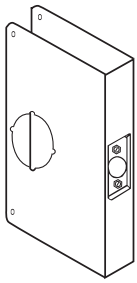

Extended
33-CW
55-CW

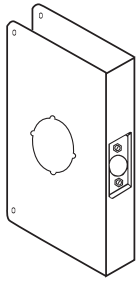

Converted
33A-CW
55A-CW

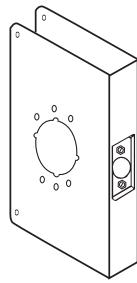

Converted
33A-2-CW
55A-2-CW

NUMBER	BACKSET	DOOR	DIMENSIONS
33-CW	3 3/4"	1 3/4"	5 1/2" x 9"
33A-2-CW	2 3/4"	1 3/4"	6 1/2" x 9"
33A-CW	2 3/4"	1 3/4"	6 1/2" x 9"
55-CW	5"	1 3/4"	6 1/2" x 9"
55A-2-CW	2 3/4"	1 3/4"	6 1/2" x 9"
55A-CW	2 3/4"	1 3/4"	6 1/2" x 9"

SHELF PACK: I Box Pack
 GAUGE: 22 (.032)
 FINISHES: 10B (613), AB (609), BZ (612), PB (605), S (630)

For THICKER DOORS

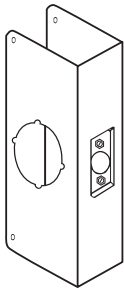

200-CW
200C-CW
212-CW
212C-CW
214-CW
214C-CW

NUMBER	BACKSET	DOOR	DIMENSIONS
200-CW	2 3/4"	2"	4 1/4" x 9"
200C-CW	2 3/8"	2"	4 1/4" x 9"
212-CW	2 3/4"	2 1/2"	4 1/4" x 9"
212C-CW	2 3/8"	2 1/2"	4 1/4" x 9"
214-CW	2 3/4"	2 1/4"	4 1/4" x 9"
214C-CW	2 3/8"	2 1/4"	4 1/4" x 9"

SHELF PACK: I Box Pack
 GAUGE: 22 (.032)
 FEATURES: • Latch hole centered in door
 • Available with lever Prep. - Custom order only
 FINISHES: 10B (613), PB (605), S (630)

DOOR REINFORCER for deadbolts & key-in-knob locks

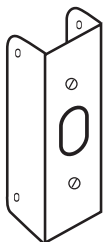

10-FE
20-FE

NUMBER	BACKSET	DOOR	DIMENSIONS
10-FE	-	1 3/8"	4 1/2" x 1"
20-FE	-	1 3/4"	4 1/2" x 1"

SHELF PACK: 10 Display Package Size - 4" x 7 3/4"
 GAUGE: 22 (.032)
 FINISHES: 10B (613), AB (609), PB (605), S (630)



MORTISE LOCK wrap-around plate for 86 cut-out

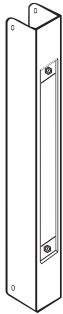

504-FE

NUMBER	BACKSET	DOOR	DIMENSIONS
504-FE	—	1 3/4"	12" x 1"

SHELF PACK: 1 Box Pack
 GAUGE: 22 (.032)
 FEATURES: 8" x 1 1/4" Recess
 FINISHES: 10B (613), S (630)

INTERIOR WRAP-AROUNDS

DON-JO MFG., INC. offers a line of Interior Wrap-Arounds. Each is manufactured from high quality prefinished steel brass plated material and is recommended for INTERIOR use only. Available for: 1, 2, 3, 4, 5, 6, 7, 8, 51, 61, 71, 81, 30, 40, 70, 80, 154, 264, 484, 151, 261, 481, 258, 942, 943

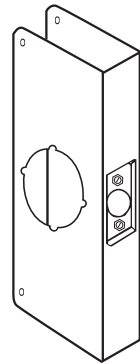

How to Order:
ie: 1-PB-IW

FLAT FRONT WRAP-AROUNDS

DON-JO MFG., INC. also offers a complete line of "original" Flat Front Wrap-Arounds. They are perfect for repairing, reinforcing or remodeling doors. Speed nuts are supplied with all Flat Front Wrap-Arounds and can be used in certain conditions when door is severely damaged or when replacing a mortise lock. Available for: 1, 2, 3, 4, 5, 6, 7, 8, 51, 61, 71, 81, 30, 40, 70, 80, 154, 264, 484, 151, 261, 481, 258, 942, 943

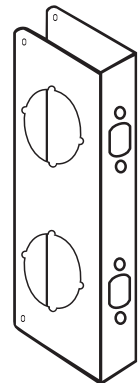
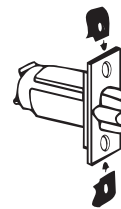

How to Order:
ie: 1-PB-VF