

# 7000 SERIES

## Architectural Exit Devices



## TABLE OF CONTENTS

### Contents

Introduction .....	3	Concealed Vertical Rod Devices	
Benefits & Features .....	4	7120(F).....	18
Finishes .....	5	7160(F).....	19
How to Order .....	6	7220.....	20
Rim Devices		7220M(F).....	21
7100(F).....	7	Trim Designs .....	22-30
7200.....	8	Electrified Options .....	31-39
7200M(F).....	9	Electrical System Guide .....	40-41
SquareBolt® Devices		Functions .....	42-43
7150(F).....	10	Applications.....	44-48
7250 .....	11	Cylinders.....	49-50
7250M(F).....	12	Collars & Tailpieces .....	53
Mortise Devices		Strikes .....	54-55
7130(F).....	13	Accessories/Options .....	56-59
Surface Vertical Rod Devices		Mullions .....	59-61
7110(F).....	14	Dimensions.....	62-63
7170(F).....	15	Sample Specifications .....	64
7210.....	16		
7210M(F).....	17		

### 7000 Series Exit Devices

ASSA ABLOY ACCENTRA™ 7000 Series Exit Devices deliver an unparalleled combination of durability, innovation and aesthetics. With ANSI/ BHMA Grade 1 certification and a full range of mechanical and electromechanical functions and accessories, the 7000 Series can be easily integrated into existing security or fire alarm systems to ensure the safety of every opening. The simple, clean lines and variety of available finishes suit the modern decor of any commercial building.

## INTRODUCTION

ASSA ABLOY ACCENTRA™ offers innovative and reliable products to solve the challenges of commercial, retail, hospitality, assisted living, mixed-use, and multi-family properties. Our door hardware expertise extends beyond products to people - and provides the service and support you expect.

Featuring durable products to meet all your facilities' requirements - and the quality you expect from a leader in the hardware industry.

ASSA ABLOY ACCENTRA™ Exit Devices			
6000 Series <small>BHMA CERTIFIED</small>	2100 Series <small>BHMA CERTIFIED</small>	1800 Series <small>BHMA CERTIFIED</small>	1500 Series <small>BHMA CERTIFIED</small>
			
<ul style="list-style-type: none"> <li>• Ideal for facilities that require modern form and full functionality to meet their life safety needs</li> <li>• Wide &amp; Narrow Stile Applications</li> <li>• Rim, Squarebolt, CVR, SVR &amp; Mortise</li> <li>• Mechanical &amp; Electro-Mechanical Functions</li> <li>• Available with Motorized Electric Latch Retraction</li> <li>• Aluminum rail assembly with Architectural Metals</li> <li>• Solid Cast Flush End Cap</li> <li>• ANSI/BHMA Certified Grade 1</li> <li>• UL Rated for Panic &amp; Fire</li> <li>• 10 Year Warranty and 2-Year Limited Warranty on Electronic Components</li> </ul>	<ul style="list-style-type: none"> <li>• Ideal for commercial applications and budget conscious end users</li> <li>• Narrow &amp; Wide Stile Applications</li> <li>• Rim, Squarebolt, CVR &amp; SVR</li> <li>• Mechanical Functions</li> <li>• ANSI/BHMA Grade 1 Certified</li> <li>• UL Rated for Panic &amp; Fire</li> <li>• Architectural &amp; Painted Finishes</li> <li>• 3 Year Warranty</li> </ul>	<ul style="list-style-type: none"> <li>• Ideal for back of the house where function and code compliance are the requirement</li> <li>• Wide Stile Applications</li> <li>• Rim &amp; SVR</li> <li>• Mechanical Functions</li> <li>• ANSI/BHMA Certified Grade 1</li> <li>• UL Rated for Panic &amp; Fire</li> <li>• Powder-coat Painted Finishes</li> <li>• 3 Year Warranty</li> </ul>	<ul style="list-style-type: none"> <li>• Ideal for renovation projects where historical preservation is the desired look</li> <li>• Wide Stile Applications</li> <li>• Rim, CVR, SVR &amp; Mortise</li> <li>• ANSI/BHMA Certified Grade 1</li> <li>• UL Rated for Panic &amp; Fire</li> <li>• Architectural &amp; Painted Finishes</li> <li>• 1 Year Warranty</li> </ul>

## BENEFITS & FEATURES

### Benefits

- **Innovative:** Featuring security options including SquareBolt® latchbolt and delayed egress function
- **Durable:** Heavy-duty steel components are ANSI/BHMA Grade 1 certified for the ultimate in strength and security
- **Flexibility:** Various options available to customize this exit device to suit any opening
- **Clean, modern look:** Sleek design with a variety of attractive finish options to suit any decor

### Features

- High quality steel chassis and heavy-duty components
- Full range of mechanical and electromechanical options to suit any life safety application and pair with existing security systems
- ANSI/BHMA Grade 1 certified
- UL/cUL listed for panic and fire doors
- Windstorm certified (refer to local codes)  Hurricane
- Five year mechanical warranty, two year warranty on electrical options and components

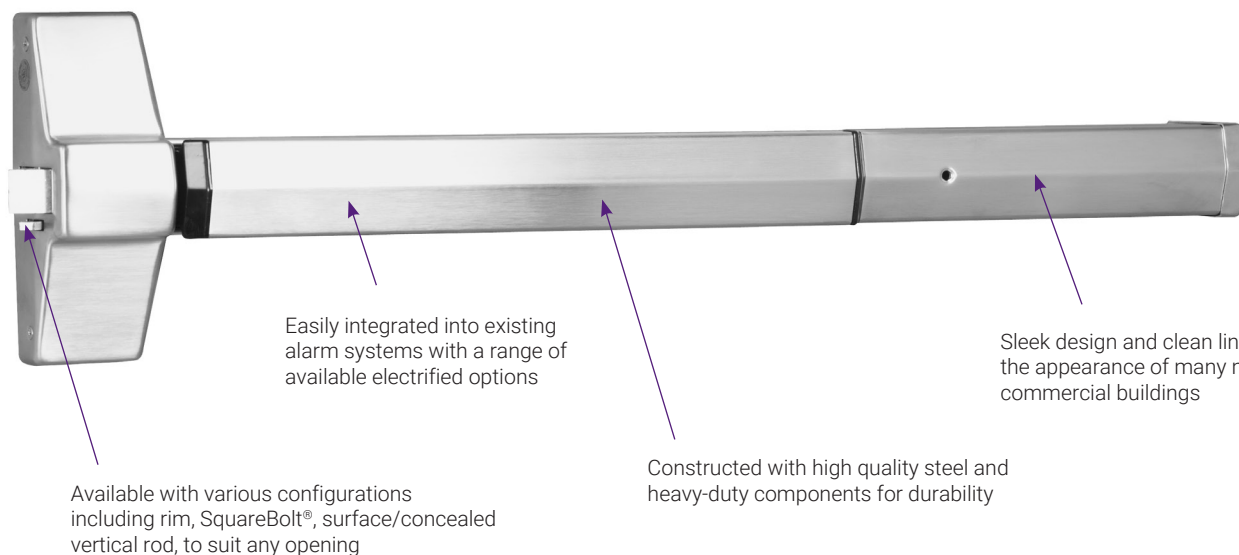









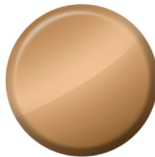

### Available with Motorized Electric Latch Retraction!

The Motorized Electric Latch Retraction (MELR) feature provides remote-controlled latch retraction that delivers quiet, smooth operation for convenient, hassle-free egress. Easily installed in new applications and available as retrofit rail kit assemblies for field updates, the MELR features maintenance-free design with few moving parts using 86% less power consumption during retraction than solenoid devices. Plus, MELR is powered by a standard power supply, simplifying installation and increasing system design flexibility. See page 32 for more details.



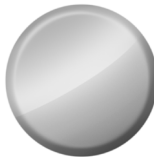
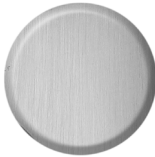
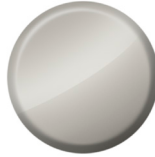

## FINISHES

ANSI/BHMA Code Finish Description				
<b>605</b> Bright Brass, Clear Coated	<b>606</b> Satin Brass, Clear Coated	<b>611</b> Bright Bronze, Clear Coated	<b>612</b> Satin Bronze, Clear Coated	<b>613E</b> Dark Oxidized Satin Bronze - equivalent
				
<b>619*</b> Satin Nickel Plated, Clear Coated	<b>625</b> Bright Chrome Plated (540F trim only)	<b>626*</b> Satin Chrome Plated (Trim only)	<b>629</b> Bright Stainless Steel	<b>630*</b> Satin Stainless Steel
				
<b>693</b> Black Painted	<b>BSP</b> Black Suede Powder Coat	<b>WSP</b> White Suede Powder Coat		
				

613, 626 and 722 finishes available as Special Product Requests only. Please contact Customer Service for more information.

\*Finish available with MicroShield® antimicrobial coating, additional finishes by special application. Consult factory for availability.

MicroShield coating may vary finish color from architectural standards. MicroShield is not intended as a substitute for traditional infection control programs such as hand hygiene or use of disinfectants. Coated products must still be cleaned to ensure the surfaces will be free of destructive microbes. ASSA ABLOY ACCENTRA™ makes no representations or warranties, express or implied, as to the efficacy of MicroShield.

### Finishes For Touchbar Covers Only

ANSI/BHMA Code	Finish Description
BN	Semi-gloss black fused polymer
LUM	Lumi-lite Photoluminescence
SS	Stainless Steel

### Lumi-Lite

Lumi-lite uses photoluminescence technology to provide visibility of exit doors in low-light, no light or smoky conditions. Lumi-lite can be ordered with your 7000 Series Exit Device or easily retrofitted to existing devices. See Lumi-lite Touchpad Cover on page 57 for more information.



## HOW TO ORDER

From this outline select the Model Number for the ASSA ABLOY ACCENTRA™ 7000 Exit Device Series you require.

7	X	X	X	Mechanical/Electrical	Size	Design	Trim	Finish	Other Info.
	<p><b>Second Digit:</b> "1" - Standard device, 4-1/2" (114mm) or wider door stile.  "2" - Narrow stile door or narrow escutcheon trim (500F, 510F Series)</p>	<p><b>Third Digit:</b> "0" - Rim Device, Pullman Latch  "1" - SVR Device up to 8'  "2" - CVR Device, Metal Doors up to 8'  "3" - Mortise Device  "5" - SquareBolt®, Rim Security  "6" - CVR Device over 8', wood door or LBR  "7" - SVR Device over 8' or LBR</p>	<p><b>Fourth Digit:</b> "0" - Standard  "5" - Cylinder Dogging (Not with suffix "F")</p>	<p><b>Mechanical Feature</b> </p> <p>"F" - Fire Exit Device "M" - Narrow escutcheon trim in 4-1/2" (114mm) or wider door stile "LBR" - Less Bottom Rod<sup>2</sup> "L5" - Mortise Device, Entry by Key with/without Rigid Lever<sup>1</sup> "L8" - Mortise Device, Entry by Lever "T5" - Mortise Device with Thumbpiece Trim "T8" - Mortise Device, Active Thumbpiece Trim "2" - Double Cylinder Device<sup>3</sup> "WS" - Windstorm Certified Products<sup>5,6,7</sup> 5CH - 5LB pressure release<sup>8</sup></p> <p><b>Electrical Feature</b></p> <p>"A" - Alarm Kit "B" - Bar Monitor or Signaling "D" - Delayed Egress "O" - Outside Trim Monitor or Signaling "MELR" - Motorized Electric Latch Retraction "S" - Latchbolt Status Monitor or Signaling "Safe" - Mortise Device Trim Control (lever only) "Secure" - Mortise Device Trim Control (lever only)</p>		<p><b>Trim Design</b> (Lever only)</p>	<p><b>Trim Model Number</b></p>	<p><b>See page 5</b></p>	<p><b>Other Information:</b> <b>Door Hand</b> - RHR or LHR  <b>Door Thickness</b> - Over 1-3/4" (45mm)  <b>Fastener Options</b> - TORX® Security Screws SNB (wood, composite, or unreinforced metal doors)  <b>Specialty Cylinders &amp; Components</b>  <b>Lumi-lite:</b> LUM</p>

## Ordering Examples

### Exit Device Only

7150D-36 x 619 x RHR x SNB

### Exit Device with Trim and Cylinder

7170F90-9-48 x AU626F x 605 x LHR x 1109 GA 0-bit

### Trim Only

M0656F x 630 x RHR x LC

### Double Cylinder Exit Device with Trim

7150F-2-36 x AU626F x 630

It is recommended that exit devices and trim for the same opening be ordered together. Standard product is for 1-3/4" (44mm) reinforced metal doors. Accessories detached from the device and trim should be specified separately. Materials by others are required to be fit for the purpose as detailed in this catalog and the product installation literature.

### Notes:

1. Required for electrical feature, Suffix "-SAFE" or "-SECURE".
2. LBR available on 7160(F90) and 7170(F90) devices only.
3. For double cylinder devices, suffix "-2" after fourth digit.
4. If "-24" device is to be used with a DOW greater than 24", the device will ship without UL label. The 12" touchpad will not cover 50% of the device touchbar length.
5. "WS" applies only to 7150(F), 7250M(F) and 7170(F) devices.
6. Maximum opening size 8'0" x 8'0".
7. Contact Ceco, Curries® or Fleming for detailed frame/door requirements and limitations.
8. 5CH applies only to 7100 devices.

## 7100(F) RIM

The 7100(F) is a rim exit device to be used with single doors or pairs of doors constructed of metal, wood or composite materials. Designed for application in high-use areas, the 7100(F) comes in a variety of finishes and can be combined with a variety of trims to match any desired style.



### Features

- Designed for wide stile doors
- 3/4" throw deadlocking stainless steel pullman latchbolt
- Electroplated ferrous components provide corrosion resistance
- Available in double cylinder function (handing must be specified)

### Applications

- Non-handed for easy installation
- Single swing doors
- Pairs of doors with removable mullions
- Metal, wood or composite door materials

### Specifications

<b>Door Opening Width</b>	-24 for 24" (60cm) doors -36 for 30" - 36" (76cm - 91cm) doors -48 for 36" - 48" (91cm - 122cm) doors Optional sizes can be special ordered. Consult Technical Product Support.
<b>Door Thickness</b>	1-3/4" (44mm) standard. Optional door thicknesses available to 4-1/2"; specify door thickness when ordering.
<b>Minimum Stile Width</b>	4-1/2" (114mm)
<b>Projection</b>	3-1/4" (83mm) active, 2-3/4" (70mm) dogged
<b>Latchbolt</b>	3/4" (19mm) deadlocking stainless steel pullman-type
<b>Strike</b>	757F, 793 optional (double door application, panic only)
<b>Fasteners</b>	Machine screws and wood door fasteners standard for panic hardware. Sex nuts and bolts supplied standard for fire exit hardware.
<b>Trims</b>	620F series escutcheon trim, 630F series pull/thumbpiece trim, 680F series offset pull trim, 540F series rose trim, 121NL cylinder only. See pages 22-24.
<b>ANSI/BHMA</b>	Certified A156.3 Type 1, Grade 1
<b>UL/cUL</b>	FVSR/FVSR - Panic hardware; GXHX/GXHX7 - Fire exit hardware (F) (4' x 8' single, 8' x 8' pairs, 3 hr.)
<b>Dogging</b>	Hex key dogging supplied standard on panic devices
<b>Options</b>	Cylinder dogging, shim kit #723, sex nuts and bolts, MicroShield®, Lumi-lite
<b>Warranty</b>	5-year limited

## 7200 RIM

The 7200 is a narrow stile rim exit device compatible with the aesthetics and functional requirements of contemporary doors. The 7200 comes in varied finishes and can be combined with a variety of trims to match any desired style.



### Features

- Designed for narrow stile doors
- 3/4" throw deadlocking stainless steel pullman latch
- Non-handed for easy installation

### Applications

- Single swing narrow stile doors
- Pairs of narrow stile doors with removable mullions
- Metal and aluminum doors
- For panic-rated doors only

### Specifications

<b>Door Opening Width</b>	-24 for 24" (60cm) doors -36 for 30" - 36" (76cm - 91cm) doors -48 for 36" - 48" (91cm - 122cm) doors Optional sizes can be special ordered. Consult Technical Product Support.
<b>Door Thickness</b>	1-3/4" (44mm) standard. 2" (51mm) and 2-1/4" (57mm); specify when ordering.
<b>Minimum Stile Width</b>	2" (51mm)
<b>Projection</b>	3-1/4" (83mm) active, 2-3/4" (70mm) dogged
<b>Latchbolt</b>	3/4" (19mm) deadlocking stainless steel pullman type.
<b>Strike</b>	Standard: 759. Optional: 793 (double door applications, panic only)
<b>Fasteners</b>	Machine screws standard for panic hardware
<b>Trims</b>	500F series escutcheon trim, 510F series pull/thumbpiece trim, 480F series offset pull trim. See pages 25-26.
<b>ANSI/BHMA</b>	A156.3, Type 4, Grade 1
<b>UL/cUL</b>	FVSR/FVSR7 - Panic hardware
<b>Dogging</b>	Hex key dogging supplied standard
<b>Options</b>	Cylinder dogging, shim kit #723NS, sex nuts and bolts, MicroShield®, Lumi-lite
<b>Warranty</b>	5-year limited

## 7200M(F) RIM

The 7200M(F) rim exit device provides the appearance of a narrow stile rim exit device for use on wide stile or flush doors. Using the 7200M(F) with narrow stile trim provides design continuity and pleasing aesthetics when matching exit devices for inside doors to outside narrow stile doors.



### Features

- Narrow stile appearance designed for wide stile or flush doors
- 3/4" throw deadlocking stainless steel pullman latchbolt
- Non-handed for easy installation
- Fully adjustable surface mounted 3/8" diameter roller strike complete with positive locking plate and shims

### Applications

- Single swing doors
- Pairs of doors with removable mullions
- Metal, wood or composite door materials

### Specifications

<b>Door Opening Width</b>	-24 for 24" (60cm) doors -36 for 30" - 36" (76cm - 91cm) doors -48 for 36" - 48" (91cm - 122cm) doors Optional sizes can be special ordered. Consult Technical Product Support.
<b>Door Thickness</b>	1-3/4" (44mm) standard. 2" (51mm) and 2-1/4" (57mm); specify when ordering.
<b>Minimum Stile Width</b>	4-1/2" (114mm)
<b>Projection</b>	3-1/4" (83mm) active, 2-3/4" (70mm) dogged
<b>Latchbolt</b>	3/4" (19mm) deadlocking stainless steel pullman type
<b>Strike</b>	757F, 793 optional (double door application, panic only)
<b>Fasteners</b>	Machine screws and wood door fasteners standard for panic hardware. Sex nuts and bolts supplied standard for fire exit hardware.
<b>Trims</b>	500F series escutcheon trim, 510F series pull/thumbpiece trim, 480F series offset pull trim. See pages 25-26.
<b>ANSI/BHMA</b>	A156.3, Type 4, Grade 1
<b>UL/cUL</b>	FVSR/FVSR7 - Panic hardware; GXHX/GXHX7 - Fire exit hardware (F) (4' x 8' single, 8' x 8' pairs, 3 hr.)
<b>Dogging</b>	Hex key dogging supplied standard on panic devices
<b>Options</b>	Cylinder dogging, shim kit #723NS, sex nuts and bolts, MicroShield®, Lumi-lite
<b>Warranty</b>	5-year limited

## 7150(F) RIM SQUAREBOLT®

Just as easy to open as traditional latchbolts, the SquareBolt® exit device's unique construction offers innovative protection. Its SquareBolt design presents an improved physical barrier over standard rim latchbolts. The SquareBolt exit device locks into place and stays there. Credit cards, crowbars, door rattling and shaking are resisted, significantly reducing the threat of unauthorized entry.

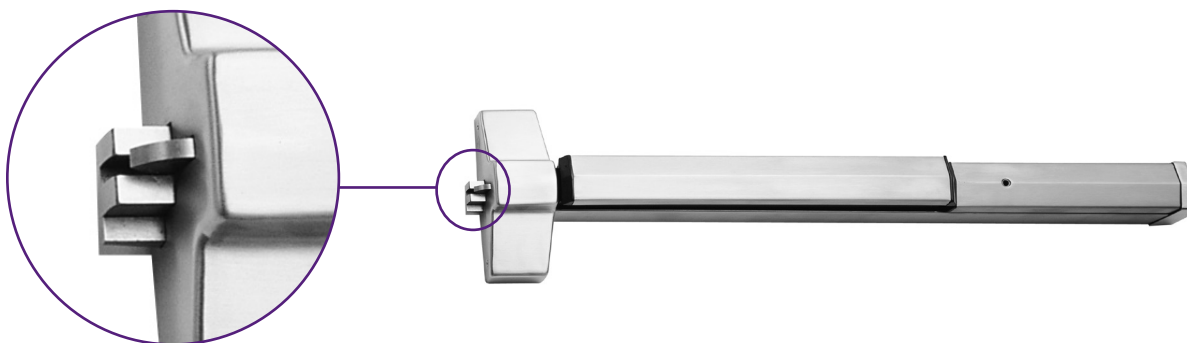

### Features

- SquareBolt security deadbolt designed for maximum holding power
- Non-handed for easy installation
- Can be retrofitted onto existing 7100 series templated doors
- Fully adjustable surface-mounted 3/8" diameter roller strike complete with positive locking plate and shims
- Available in double cylinder function (handing must be specified)
- Available certified hurricane resistant (refer to local codes). Specify 7150(F)WS  Hurricane

### Applications

- Single swing doors
- Pairs of doors with removable mullions
- Metal, wood or composite door materials

### Specifications

<b>Door Opening Width</b>	-24 for 24" (60cm) doors -36 for 30" - 36" (76cm - 91cm) doors -48 for 36" - 48" (91cm - 122cm) doors Optional sizes can be special ordered. Consult Technical Product Support.
<b>Door Thickness</b>	1-3/4" (44mm) standard. Optional door thicknesses available to 4-1/2"; specify door thickness when ordering.
<b>Minimum Stile Width</b>	4-1/2" (114mm)
<b>Projection</b>	3-1/4" (83mm) active, 2-3/4" (70mm) dogged
<b>Deadbolt</b>	1" (25mm) slide projection bolt with full 3/4" (19mm) projection
<b>Strike</b>	757F, 793 optional (double door application, panic only)
<b>Fasteners</b>	Machine screws and wood door fasteners standard for panic hardware. Sex nuts and bolts supplied standard for fire exit hardware.
<b>Trims</b>	620F series escutcheon trim, 630F series pull/thumbpiece trim, 680F series offset pull trim, 540F series rose trim, 121NL cylinder only. See pages 22-24.
<b>ANSI/BHMA</b>	A156.3, Type 4 or 28, Grade 1
<b>UL/cUL</b>	FVSR/FVSR7 - Panic hardware; GXHX/GXHX7 - Fire exit hardware (F) (4' x 8' single, 8' x 8' pairs, 3 hr.); ZHEM - Latching hardware; ZHLA - Windstorm rated assemblies
<b>Dogging</b>	Hex key dogging supplied standard on panic devices
<b>Options</b>	Cylinder dogging, shim kit #723, sex nuts and bolts, MicroShield®, Lumi-lite
<b>Warranty</b>	5-year limited

## 7250 RIM SQUAREBOLT®

The unique construction of the SquareBolt exit device offers innovative protection. The square latchbolt design provides an improved physical barrier over standard pullman-type rim latchbolts. It locks into place and stays there. Credit cards, crowbars, door rattling and shaking are resisted, significantly reducing the threat of unauthorized entry, especially in applications that include removable mullions. The 7250 SquareBolt is designed for narrow stile doors.

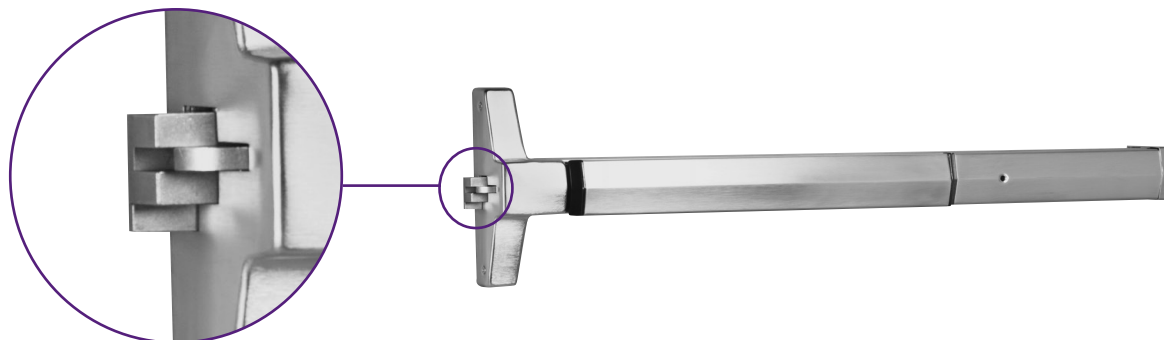

### Features

- SquareBolt security deadbolt designed for maximum holding power
- Non-handed for easy installation
- Maintains the look of the 7200 series architectural exit devices, allowing for continuity in both design and finish
- Fully adjustable surface mounted 3/8" diameter roller strike complete with positive locking plate and shims
- Used with narrow stile trim

### Applications

- Single swing narrow stile doors
- Pairs of narrow stile doors with removable mullions
- Metal and aluminum doors
- For panic-rated doors only

### Specifications

<b>Door Opening Width</b>	-24 for 24" (60cm) doors -36 for 30" - 36" (76cm - 91cm) doors -48 for 36" - 48" (91cm - 122cm) doors Optional sizes can be special ordered. Consult Technical Product Support.
<b>Door Thickness</b>	1-3/4" (44mm) standard. 2" and 2-1/4" (51mm and 57mm); specify when ordering.
<b>Minimum Stile Width</b>	2" (51mm)
<b>Projection</b>	3-1/4" (83mm) active, 2-3/4" (70mm) dogged
<b>Latchbolt</b>	1" (25mm) slide projection bolt with full 3/4" (19mm) projection
<b>Strike</b>	Standard: 759. Optional: 793 (double door applications, panic only)
<b>Fasteners</b>	Machine screws standard for panic hardware
<b>Trims</b>	500F series escutcheon trim, 510F series pull/thumbpiece trim, 480F series offset pull trim. See pages 25-26.
<b>ANSI/BHMA</b>	Certified A156.3, Type 4 or 28, Grade 1
<b>UL/cUL</b>	FVSR/FVSR7 - Panic hardware
<b>Dogging</b>	Hex key dogging supplied standard
<b>Options</b>	Cylinder dogging, shim kit #723NS, sex nuts and bolts, MicroShield®, Lumi-lite
<b>Warranty</b>	5-year limited

## 7250M(F) RIM SQUAREBOLT®

The unique construction of the 7250M(F) SquareBolt exit device offers innovative protection while maintaining the appearance of a narrow stile exit device. The square latchbolt design provides an improved physical barrier over standard pullman-type latchbolts. The 7250M(F) SquareBolt is designed for wide stile or flush doors and provides design continuity of the 7200 series exit devices.

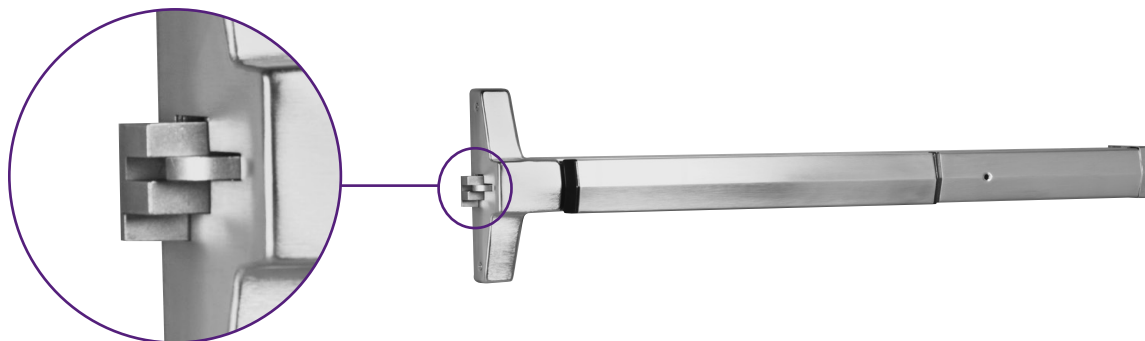

### Features

- SquareBolt security deadbolt designed for maximum holding power
- Non-handed for easy installation
- Maintains the look of the 7200 series architectural exit devices, allowing for continuum in both design and finish
- Fully adjustable surface mounted 3/8" diameter roller strike complete with positive locking plate and shims
- Used with narrow stile trim
- Available certified hurricane resistant (refer to local codes). Specify 7250M(F)WS



Hurricane

### Applications

- Single swing doors
- Pairs of doors with removable mullions
- Metal, wood or composite door materials

### Specifications

<b>Door Opening Width</b>	-24 for 24" (60cm) doors -36 for 30" - 36" (76cm - 91cm) doors -48 for 36" - 48" (91cm - 122cm) doors Optional sizes can be special ordered. Consult Technical Product Support.
<b>Door Thickness</b>	1-3/4" (44mm) standard. 2" (51mm) and 2-1/4" (57mm); specify when ordering.
<b>Minimum Stile Width</b>	4-1/2" (114mm)
<b>Projection</b>	3-1/4" (83mm) active, 2-3/4" (70mm) dogged
<b>Deadbolt</b>	1" (25mm) slide projection bolt with full 3/4" (19mm) projection
<b>Strike</b>	757F, 793 optional (double door application, panic only)
<b>Fasteners</b>	Machine screws and wood door fasteners standard for panic hardware. Sex nuts and bolts supplied standard for fire exit hardware.
<b>Trims</b>	500F series escutcheon trim, 510F series pull/thumbpiece trim, 480F series offset pull trim. See pages 25-26.
<b>ANSI/BHMA</b>	Certified A156.3, Type 4 or 28, Grade 1
<b>UL/cUL</b>	FVSR/FVSR7 - Panic hardware; GXHX/GXHX7 - Fire exit hardware (F) (4' x 8' single, 8' x 8' pairs, 3 hr.); ZHEM - Latching hardware; ZHLA - Windstorm rated assemblies
<b>Dogging</b>	Hex key dogging supplied standard on panic devices
<b>Options</b>	Cylinder dogging, shim kit #723NS, sex nuts and bolts, MicroShield®, Lumi-lite
<b>Warranty</b>	5-year limited





## 7130(F) MORTISE

The 7130(F) is an exit device integrated with the ASSA ABLOY ACCENTRA™ 8700 Series Mortise Lock for use on single doors or active leaf of a pair of doors where life safety and extra security are required. The 8700 Series Mortise Lock used is modified for use with exit devices only.



### Applications

- Single swing doors
- Pairs of doors with vertical rod devices or automatic flush bolts
- Metal, wood or compatible door materials

Order as follows, according to function.	
<b>7130-K5(F)</b>	(01) Exit only.
	(02) Entry by pull when dogged.
	(03) Key retracts latchbolt.
Electrical control for trim, w/wo key override.	
<b>7130-L5(F)</b>	(02) Entry by rigid lever when dogged.
	(03) Key retracts latchbolt.
	Electrical control for trim, w/wo key override.
<b>7130-T5(F)</b>	(02) Entry by pull when dogged. (03) Key retracts latchbolt.
<b>7130-L8(F)</b>	(08) Entry by lever lock/unlocked by key or lever only (passage).
<b>7130-L8(F)-2</b>	(08) Entry by lever lock/unlocked by key either side or lever only (passage).
<b>7130-T8(F)</b>	(05) Entry by thumbpiece lock/unlocked by key or thumbpiece only (passage).

### Specifications

<b>Door Opening Width</b>	-24 for 24" (60cm) doors -36 for 30" - 36" (76cm - 91cm) doors -48 for 36" - 48" (91cm - 122cm) doors Optional sizes can be special ordered. Consult Technical Product Support.
<b>Door Thickness</b>	1-3/4" (44mm) standard. 2" and 2-1/4" (51mm and 57mm) optional; specify when ordering.
<b>Minimum Stile Width</b>	4-1/2" (114mm)
<b>Projection</b>	3-1/4" (83mm) active, 2-3/4" (70mm) dogged
<b>Latchbolt</b>	Two piece mechanical 3/4" (19mm) deadlocking stainless steel with anti-friction insert and auxiliary deadlocking latch
<b>Strike</b>	Curved lip, non-handed 798. Optional 712 for door pairs with astragals. Optional 718 open back strike.
<b>Fasteners</b>	Machine screws and wood door fasteners standard for panic hardware. Sex nuts and bolts supplied standard for fire exit hardware.
<b>Trims</b>	620F/650F series escutcheon trim, 630F/660F/670F series pull/thumbpiece trim, 684F offset pull trim. See pages 22-24.
<b>ANSI/BHMA</b>	Certified A156.3 Type 3, Grade 1
<b>UL/cUL</b>	FVSR/FVSR7 - Panic hardware; GXHX/GXHX7 - Fire exit hardware (F) (4' x 8' single, 8' x 8' pairs, 3 hr.) (4' x 9' single, 8' x 9' pairs, 1-1/2 hr.)
<b>Dogging</b>	Hex key dogging supplied standard on panic devices
<b>Options</b>	Cylinder dogging, shim kit #723, sex nuts and bolts, MicroShield®, Lumi-lite
<b>Warranty</b>	5-year limited

## 7110(F) SURFACE VERTICAL ROD

The 7110(F) is a surface vertical rod exit device to be used on wide stile or flush doors up to 8' (fire) and 10' (panic) where two-point latching is desired.

### Features

- Designed for wide stile and flush doors
- Handed. Specify hand (field reversible)
- Bottom deadbolt for secure latching
- Fully adjustable roller strike

### Applications

- Pairs of doors
- Double egress
- Metal, wood or composite door materials



### Specifications

<b>Door Opening Width</b>	-24 for 24" (60cm) doors -36 for 30" - 36" (76cm - 91cm) doors -48 for 36" - 48" (91cm - 122cm) doors Optional sizes can be special ordered. Consult Technical Product Support.
<b>Door Opening Height</b>	Standard door height 7' (213cm), with the device centerline at 39-15/16" (101cm) from floor. Optional heights up to 8' (fire) and 10' (panic) available by using rod extensions. For fire rated openings over 8', see 7170F SVR.
<b>Door Thickness</b>	1-3/4" (44mm) standard. Optional door thicknesses available to 4-1/2"; specify door thickness when ordering.
<b>Minimum Stile Width</b>	4-1/2" (114mm)
<b>Projection</b>	3-1/4" (83mm) active, 2-3/4" (70mm) dogged
<b>Latchbolt</b>	Top: 3/4" (19mm) throw, pullman-type with automatic deadlatching Bottom: 5/8" (16mm) throw deadbolt, held retracted during door swing
<b>Vertical Rods</b>	1/2" O.D. tubular brass, bronze or stainless steel with rod guides
<b>Strike</b>	Top: Roller type 791. Bottom: Flush mounted 790. 794 floor strike optional (threshold openings).
<b>Fasteners</b>	Machine screws and wood door fasteners standard for panic hardware. Sex nuts and bolts supplied standard for fire exit hardware.
<b>Trims</b>	620F series escutcheon trim, 630F series pull/thumbpiece trim, 680F series offset pull trim, 540F series rose trim. See pages 22-24.
<b>ANSI/BHMA</b>	Certified A156.3 Type 2, Grade 1
<b>UL/cUL</b>	FVSR/FVSR7 - Panic hardware; GXHX/GXHX7 - Fire exit hardware (F) (8' x 8' pairs, 3 hr.)
<b>Dogging</b>	Hex key dogging supplied standard on panic devices
<b>Options</b>	Cylinder dogging, shim kit #724, sex nuts and bolts, rod extensions, bottom pullman latch (panic only) MicroShield®, Lumi-lite
<b>Warranty</b>	5-year limited

## 7170(F) SURFACE VERTICAL ROD

The 7170(F) is a surface vertical rod exit device to be used on wide stile and flush doors up to 10' where one- or two-point latching is desired. A Less Bottom Rod (LBR) option is available.

### Features

- Designed for wide stile and flush doors
- Handed. Specify hand (field reversible)
- Interlocking top strike and latch mounting plate
- Available less bottom rod (LBR option)
- Available certified hurricane resistant (refer to local codes ~ not approved for LBR). Specify 7170(F)WS



### Applications

- Pairs of doors
- Double egress
- Metal or wood doors

### Specifications

<b>Door Opening Width</b>	-24 for 24" (60cm) doors -36 for 30" - 36" (76cm - 91cm) doors -48 for 36" - 48" (91cm - 122cm) doors Optional sizes can be special ordered. Consult Technical Product Support.
<b>Door Opening Height</b>	Standard door height 7' (213cm), with the device centerline at 39-15/16" (101cm) from floor. Optional heights specify suffix -8, -9, -10.
<b>Door Thickness</b>	1-3/4" (44mm) standard. Optional door thicknesses available to 4-1/2"; specify door thickness when ordering.
<b>Minimum Stile Width</b>	4-1/2" (114mm)
<b>Projection</b>	3-1/4" (83mm) active, 2-3/4" (70mm) dogged
<b>Latchbolt</b>	Top: 3/4" (19mm) throw, pullman-type with automatic deadlatching Bottom: 5/8" (16mm) throw deadbolt, held retracted during door swing
<b>Vertical Rods</b>	1/2" O.D. tubular brass, bronze or stainless steel with rod guides
<b>Strike</b>	Top: 726. Bottom: Flush-mounted 790. 794 floor strike optional (threshold openings).
<b>Fasteners</b>	Machine screws and wood door fasteners standard for panic hardware. Sex nuts and bolts supplied standard for fire exit hardware.
<b>Trims</b>	620F series escutcheon trim, 630F series pull/thumbpiece trim, 680F series offset pull trim, 540F series rose trim. See pages 22-24.
<b>ANSI/BHMA</b>	Certified A156.3 Type 2, Grade 1
<b>UL/cUL</b>	FVSR/FVSR7 - Panic hardware; GXHX/GXHX7 - Fire exit hardware (F) (8' x 10' pairs, 1-1/2 hr.) (8' x 8' pairs, 3 hr.); ZHEM - Latching hardware; ZHLA - Windstorm rated assemblies
<b>Dogging</b>	Hex key dogging supplied standard on panic devices
<b>Options</b>	Cylinder dogging, shim kit #724, sex nuts and bolts, bottom pullman latch (panic only), less bottom rod (LBR), -8, -9, -10 opening height, rod extensions, MicroShield®, Lumi-lite.
<b>Warranty</b>	5-year limited

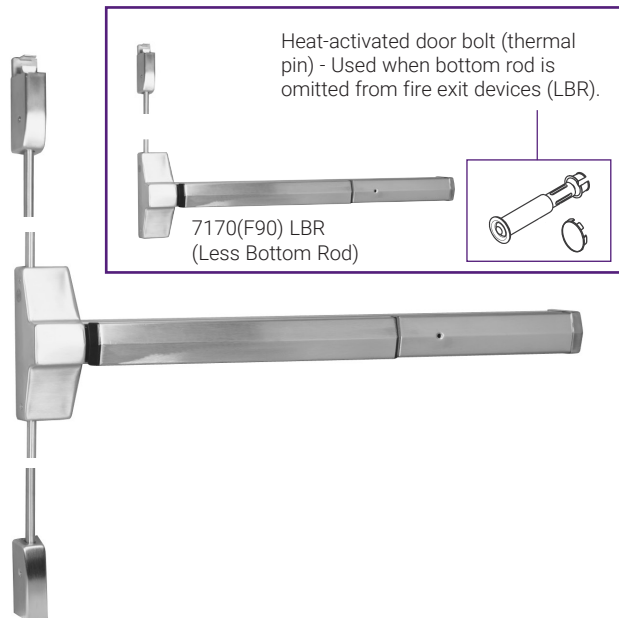

## 7210 SURFACE VERTICAL ROD

The 7210 is a narrow stile surface vertical rod exit device to be used on narrow stile, aluminum and metal doors where two-point latching is desired.

### Features

- Designed for narrow stile doors
- Handed. Specify hand (field reversible)
- Bottom deadbolt for secure latching
- Fully adjustable roller strike

### Applications

- Pairs of narrow stile doors
- Metal and aluminum doors
- For panic-rated doors only



### Specifications

<b>Door Opening Width</b>	-24 for 24" (60cm) doors -36 for 30" - 36" (76cm - 91cm) doors -48 for 36" - 48" (91cm - 122cm) doors Optional sizes can be special ordered. Consult Technical Product Support.
<b>Door Opening Height</b>	Standard door height 7' (213mm), with the device centerline at 39-15/16" (101cm) from floor. Optional heights specify suffix -8, -9, -10.
<b>Door Thickness</b>	1-3/4" (44mm) standard. 2" (51mm) and 2-1/4" (57mm); specify when ordering.
<b>Minimum Stile Width</b>	2" (51mm).
<b>Projection</b>	3-1/4" (83mm) active, 2-3/4" (70mm) dogged
<b>Latchbolt</b>	Top: 3/4" (19mm) stainless steel throw, pullman-type with automatic deadlatching. Bottom: 5/8" (16mm) throw deadbolt, held retracted during door swing.
<b>Vertical Rods</b>	1/2" (13mm) O.D. tubular brass, bronze or stainless steel with rod guides.
<b>Strike</b>	Top: Roller type 791. Bottom: Flush mounted 790. 794 floor strike optional (threshold openings).
<b>Fasteners</b>	Machine screws standard for panic hardware.
<b>Trims</b>	500F series escutcheon trim, 510F series pull/thumbpiece trim, 480F series offset pull trim. See pages 25-26.
<b>ANSI/BHMA</b>	Certified A156.3 Type 5, Grade 1
<b>UL/cUL</b>	FVSR/FVSR7 - Panic hardware
<b>Dogging</b>	Hex key dogging supplied standard
<b>Options</b>	Cylinder dogging, shim kit #724, sex nuts and bolts, -8, -9, -10 opening height, rod extensions, bottom pullman latch, MicroShield®, Lumi-lite
<b>Warranty</b>	5-year limited

## 7210M(F) SURFACE VERTICAL ROD

The 7210M(F) is a narrow appearance surface vertical rod exit device to be used on wide stile and flush metal or wood doors where two-point latching is desired.

### Features

- Narrow stile appearance designed for wide stile doors
- Handed. Specify hand (field reversible)
- Fully adjustable roller strike

### Applications

- Pairs of doors
- Double egress
- Metal, wood or composite door materials



### Specifications

<b>Door Opening Width</b>	-24 for 24" (60cm) doors -36 for 30" - 36" (76cm - 91cm) doors -48 for 36" - 48" (91cm - 122cm) doors Optional sizes can be special ordered. Consult Technical Product Support.
<b>Door Opening Height</b>	Standard door height 7' (213mm), with the device centerline at 39-15/16" (101cm) from floor. Optional heights specify suffix -8 (fire and panic), -9, -10 (panic only).
<b>Door Thickness</b>	1-3/4" (44mm) standard. 2" (51mm) and 2-1/4" (57mm); specify when ordering.
<b>Minimum Stile Width</b>	4-1/2" (114mm)
<b>Projection</b>	3-1/4" (83mm) active, 2-3/4" (70mm) dogged
<b>Latchbolt</b>	Top: 3/4" (19mm) stainless steel throw, pullman-type with automatic deadlatching. Bottom: 5/8" (16mm) throw deadbolt, held retracted during door swing.
<b>Vertical Rods</b>	1/2" (13mm) O.D. tubular brass, bronze or stainless steel with rod guides.
<b>Strike</b>	Top: Roller type 791. Bottom: Flush mounted 790. 794 floor strike optional (threshold openings).
<b>Fasteners</b>	Machine screws and wood door fasteners standard for panic hardware. Sex nuts and bolts supplied standard for fire exit hardware.
<b>Trims</b>	500F series escutcheon trim, 510F series pull/thumbpiece trim, 480F series offset pull trim. See pages 25-26.
<b>ANSI/BHMA</b>	Certified A156.3, Type 5, Grade 1
<b>UL/cUL</b>	FVSR/FVSR7 - Panic hardware; GXHX/GXHX7 - Fire exit hardware (F) (8' x 8' pairs, 3 hr.)
<b>Dogging</b>	Hex key dogging supplied standard on panic devices
<b>Options</b>	Cylinder dogging, shim kit #724NS, sex nuts and bolts, bottom pullman latch (panic only), -8, -9, -10 opening height, rod extensions, MicroShield®, Lumi-lite
<b>Warranty</b>	5-year limited



## 7120(F) CONCEALED VERTICAL ROD

The 7120(F) is a concealed vertical rod exit device to be used on metal doors only up to 8' (fire) and 10' (panic) where two-point latching is desired.

### Features

- Designed for wide stile and flush doors
- Handed. Specify hand (field reversible)
- Bottom deadbolt for secure latching
- Fully adjustable roller strike

### Applications

- Pairs of doors
- Double egress
- Metal doors only



### Specifications

<b>Door Opening Width</b>	-24 for 24" (60cm) doors -36 for 30" - 36" (76cm - 91cm) doors -48 for 36" - 48" (91cm - 122cm) doors Optional sizes can be special ordered. Consult Technical Product Support.
<b>Door Opening Height</b>	Standard door height adjustable to 8' (244cm), with the device centerline at 39-15/16" (101cm) from floor. Optional heights up to 10' (panic) available by using rod extensions. For fire rated openings over 8', see 7160F CVR.
<b>Door Thickness</b>	1-3/4" (44mm) standard. 2" and 2-1/4" (51mm and 57mm) optional; specify when ordering.
<b>Minimum Stile Width</b>	4-1/2" (114mm)
<b>Projection</b>	3-1/4" (83mm) active, 2-3/4" (70mm) dogged
<b>Latchbolt</b>	Top: 3/4" (19mm) throw, pullman-type with automatic deadlatching Bottom: 5/8" (16mm) throw deadbolt, held retracted during door swing
<b>Vertical Rods</b>	1/2" (13mm) O.D. telescoping tubular rods
<b>Strike</b>	Top: Roller type 791 (panic and fire). Bottom: Flush mounted 790 (panic and fire). 794 floor strike optional (threshold openings).
<b>Fasteners</b>	Machine screws standard for panic hardware. Sex nuts and bolts supplied standard for fire exit hardware.
<b>Trims</b>	620F series escutcheon trim, 630F series pull/thumbpiece trim, 680F series offset pull trim, 540F series rose trim. See pages 22-24.
<b>ANSI/BHMA</b>	Certified A156.3 Type 8, Grade 1
<b>UL/cUL</b>	FVSR/FVSR7 - Panic hardware; GXHX/GXHX7 - Fire exit hardware (F) (8' x 8' pairs, 3 hr.)
<b>Dogging</b>	Hex key dogging supplied standard on panic devices
<b>Options</b>	Cylinder dogging, shim kit #723, sex nuts and bolts, rod extensions, bottom pullman latch (panic only) MicroShield®, Lumi-lite
<b>Warranty</b>	5-year limited

Note: Not available with Less Bottom Rod option



## 7160(F) CONCEALED VERTICAL ROD

The 7160(F) is a concealed vertical rod exit device to be used on wood and metal doors up to 10' where one- or two-point latching is desired. A Less Bottom Rod (LBR) option is available.

### Features

- Designed for wide stile and flush doors
- Handed. Specify hand (field reversible)
- Mortised top strike
- Available less bottom rod (LBR option)

### Applications

- Pairs of doors
- Double egress
- Metal, wood, or composite door materials

### Specifications

<b>Door Opening Width</b>	-24 for 24" (60cm) doors -36 for 30" - 36" (76cm - 91cm) doors -48 for 36" - 48" (91cm - 122cm) doors Optional sizes can be special ordered. Consult Technical Product Support.
<b>Door Opening Height</b>	Standard door height adjustable to 8' (244cm), with the device centerline at 39-15/16" (101cm) from floor. Optional heights specify suffix -9, -10.
<b>Door Thickness</b>	1-3/4" (44mm) standard. 2" and 2-1/4" (51mm and 57mm) optional; specify when ordering.
<b>Minimum Stile Width</b>	4-1/2" (114mm)
<b>Projection</b>	3-1/4" (83mm) active, 2-3/4" (70mm) dogged
<b>Latchbolt</b>	Top: 3/4" (19mm) throw, pullman-type with automatic deadlatching Bottom: 5/8" (16mm) throw deadbolt, held retracted during door swing
<b>Vertical Rods</b>	1/2" (13mm) O.D. telescoping tubular rods
<b>Strike</b>	Top: Mortised 761. Bottom: Flush mounted 790. 794 floor strike optional (threshold openings).
<b>Fasteners</b>	Machine screws and wood door fasteners standard for panic hardware. Sex nuts and bolts supplied standard for fire exit hardware.
<b>Trims</b>	620F series escutcheon trim, 630F series pull/thumbpiece trim, 680F series offset pull trim, 540F series rose trim. See pages 22-24.
<b>ANSI/BHMA</b>	Certified A156.3 Type 7 and 8, Grade 1
<b>UL/cUL</b>	FVSR/FVSR7 - Panic hardware; GXHX/GXHX7 - Fire exit hardware (F) (8' x 10' pairs, 1-1/2 hr.) (8' x 8' pairs, 3 hr.)
<b>Dogging</b>	Hex key dogging supplied standard on panic devices
<b>Options</b>	Cylinder dogging, shim kit #723, sex nuts and bolts, less bottom rod (LBR), -9, -10 opening height, rod extensions, bottom pullman latch (panic only), MicroShield®, Lumi-lite.
<b>Warranty</b>	5-year limited

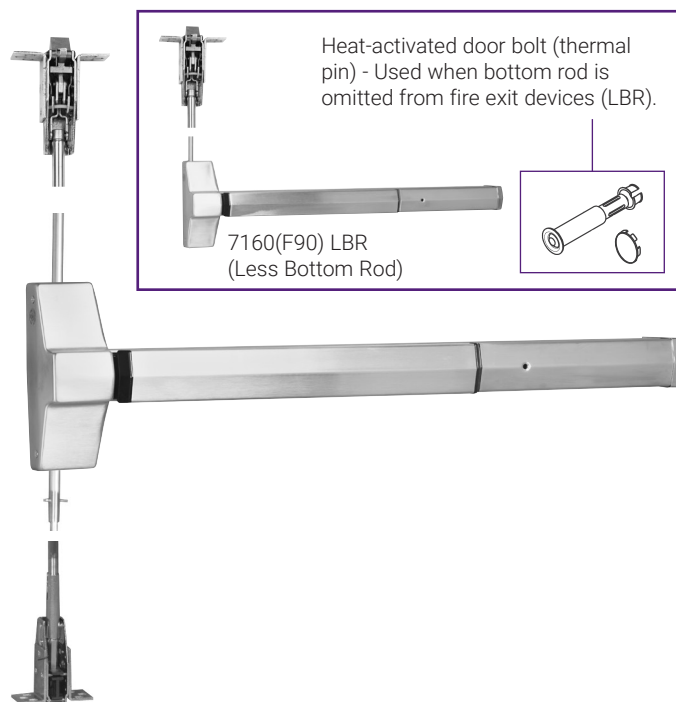

## 7220 CONCEALED VERTICAL ROD

The 7220 is a narrow stile concealed vertical rod exit device to be used on narrow stile, aluminum and metal doors where two-point latching is desired.

### Features

- Designed for narrow stile doors
- Handed. Specify hand (field reversible)
- Bottom deadbolt for secure latching
- Fully adjustable roller strike

### Applications

- Pairs of narrow stile doors
- Metal and aluminum doors
- For panic-rated doors only

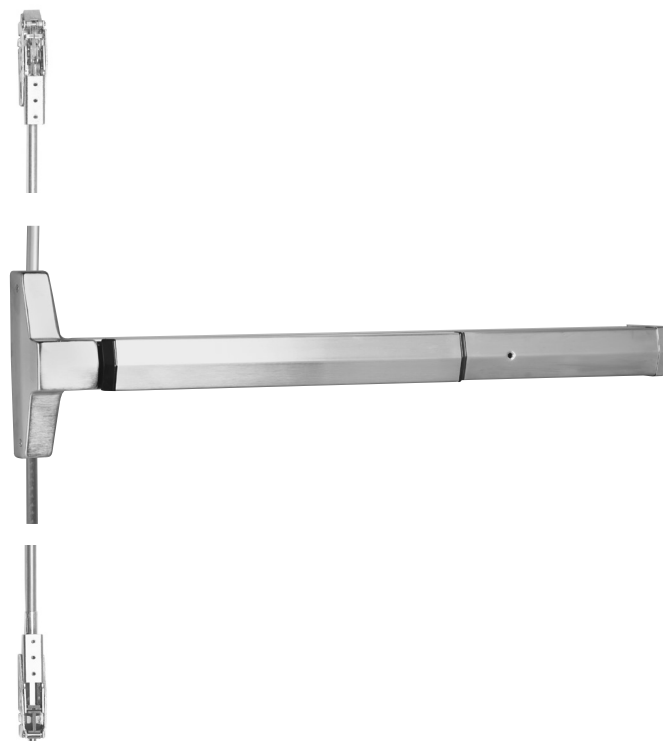

### Specifications

<b>Door Opening Width</b>	-24 for 24" (60cm) doors -36 for 30" - 36" (76cm - 91cm) doors -48 for 36" - 48" (91cm - 122cm) doors Optional sizes can be special ordered. Consult Technical Product Support.
<b>Door Opening Height</b>	Standard top rod adjustable to 7' to 8' (213cm to 244cm), with the device centerline at 39-15/16" (101cm) from floor. Optional heights specify suffix -9, -10
<b>Door Thickness</b>	1-3/4" (44mm) standard. 2" (51mm) and 2-1/4" (57mm); specify when ordering.
<b>Minimum Stile Width</b>	2" (51mm).
<b>Projection</b>	3-1/4" (83mm) active, 2-3/4" (70mm) dogged
<b>Latchbolt</b>	Top: 3/4" (19mm) stainless steel throw, pullman-type with automatic deadlatching. Bottom: 5/8" (16mm) throw deadbolt, held retracted during door swing.
<b>Vertical Rods</b>	1/2" (13mm) O.D. telescoping tubular rods
<b>Strike</b>	Top: Roller type 791. Bottom: Flush mounted 790. 794 floor strike optional (threshold openings).
<b>Fasteners</b>	Machine screws standard for panic hardware.
<b>Trims</b>	500F series escutcheon trim, 510F series pull/thumbpiece trim, 480F series offset pull trim. See pages 25-26.
<b>ANSI/BHMA</b>	Certified A156.3 Type 6, Grade 1
<b>UL/cUL</b>	FVSR/FVSR7 - Panic hardware
<b>Dogging</b>	Hex key dogging supplied standard
<b>Options</b>	Cylinder dogging, shim kit #723NS, sex nuts and bolts, -9, -10 opening height, rod extensions, bottom pullman latch, MicroShield®, Lumi-lite
<b>Warranty</b>	5-year limited



## 7220M(F) CONCEALED VERTICAL ROD

The 7220M(F) is a narrow appearance concealed vertical rod exit device for wide stile and flush metal doors only and is to be used where two-point latching is desired.

### Features

- Narrow stile look designed for wide stile doors
- Handed. Specify hand (field reversible)
- Bottom deadbolt for secure latching
- Fully adjustable roller strike

### Applications

- Pairs of doors
- Double egress
- Metal doors only



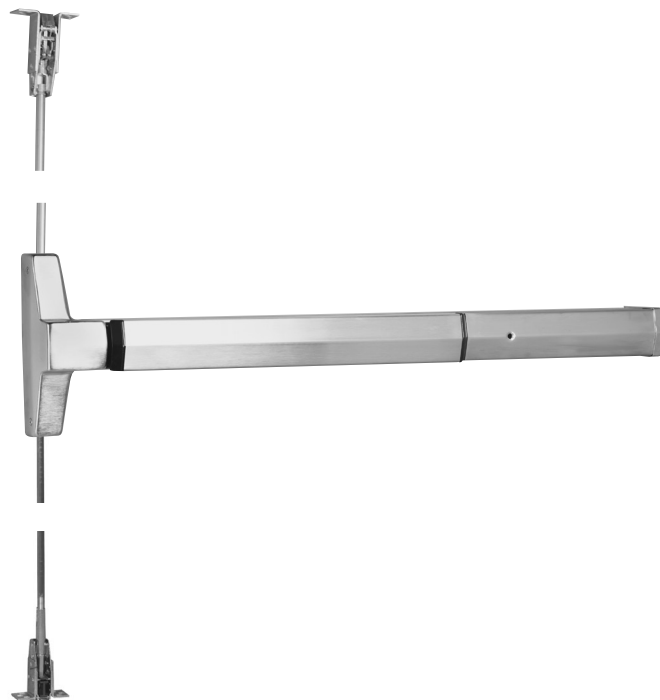



### Specifications



<b>Door Opening Width</b>	-24 for 24" (60cm) doors -36 for 30" - 36" (76cm - 91cm) doors -48 for 36" - 48" (91cm - 122cm) doors Optional sizes can be special ordered. Consult Technical Product Support.
<b>Door Opening Height</b>	Standard door height adjustable to 8' (244mm), with the device centerline at 39-15/16" (101cm) from floor. Optional heights specify suffix -9, -10 (panic only).
<b>Door Thickness</b>	1-3/4" (44mm) standard. 2" (51mm) and 2-1/4" (57mm); specify when ordering.
<b>Minimum Stile Width</b>	4-1/2" (114mm)
<b>Projection</b>	3-1/4" (83mm) active, 2-3/4" (70mm) dogged
<b>Latchbolt</b>	Top: 3/4" (19mm) stainless steel throw, pullman-type with automatic deadlatching. Bottom: 5/8" (16mm) throw deadbolt, held retracted during door swing.
<b>Vertical Rods</b>	1/2" (13mm) O.D. telescoping tubular rods.
<b>Strike</b>	Top: Roller type 791. Bottom: Flush mounted 790. 794 floor strike optional (threshold openings).
<b>Fasteners</b>	Machine screws and wood door fasteners standard for panic hardware. Sex nuts and bolts supplied standard for fire exit hardware.
<b>Trims</b>	500F series escutcheon trim, 510F series pull/thumbpiece trim, 480F series offset pull trim. See pages 25-26.
<b>ANSI/BHMA</b>	Certified A156.3, Type 8, Grade 1
<b>UL/cUL</b>	FVSR/FVSR7 - Panic hardware; GXHX/GXHX7 - Fire exit hardware (F) (8' x 8' pairs, 3 hr.)
<b>Dogging</b>	Hex key dogging supplied standard on panic devices
<b>Options</b>	Cylinder dogging, shim kit #723NS, sex nuts and bolts, bottom pullman latch (panic only), -9, -10 opening height, rod extensions, MicroShield®, Lumi-lite
<b>Warranty</b>	5-year limited

## TRIM DESIGNS

### Escutcheons

480F Series	500F Series	510F Series	620F/650F Series	630F/660F/670F Series	680F Series
					
Projection: 2-13/32" (61mm)	Projection: see levers	Projection: see levers	Projection: see levers	Projection: 2-1/8" (54mm)	Projection: see levers

### Roses

#### 540F Series



Projection: 3-1/2" (89mm)

### Standard Trims

































All ASSA ABLOY ACCENTRA™ exit device trims (except mortise trim) feature the unique Free-Wheeling lever mechanism, similar to our 5400LN cylindrical lock. This Free-Wheeling trim features a clutch mechanism which allows the lever to float down 60 degrees when operated in the locked condition, improving vandal resistance.

<b>Arcadia AR</b> 	<b>Augusta AU</b> 	<b>Carmel CR</b> 
		
Projection: 3-1/4" (82mm)	Projection: 2-5/8" (61mm)	Projection: 3-1/8" (79mm)
<b>Jefferson JN</b> 	<b>Monroe MO</b> 	<b>Pacific Beach PB</b> 
		
Projection: 2-9/16" (65mm)	Projection: 3" (76mm)	Projection: 3-5/16" (84mm)
<b>Pinehurst PN</b> 	<b>Virginia VI</b> 	<b>Hampton HA</b> 
		
Projection: 3-1/16" (78mm)	Projection: 3-1/8" (79mm)	Projection: 3-3/8" (86mm)

Note: Projection dimensions are provided using the 620F series escutcheon plates.

**TRIM DESIGNS**

**Reflections® Levers** 

<b>Hudson</b>	TB	UB	TC	TD	UC		
							
Projection	3-1/16" (78mm)	3-1/4" (83mm)	3" (76mm)	3-7/16" (87mm)	3-7/16" (87mm)		
<b>Spree</b>	RS	RT	RU	RV			
							
Projection	3-1/8" (79mm)	3-1/8" (79mm)	3-13/32" (87mm)	3" (76mm)			
<b>Seine</b>	TE	TG	TI	TJ	TK	GT	
							
Projection	3" (76mm)	2-13/16" (61mm)	3-3/8" (85mm)	3-1/16" (78mm)	3-1/4" (83mm)	3-1/4" (83mm)	
<b>Thames</b>	TM	TN	TP	TR	TS	TQ	
							
Projection	3-1/16" (78mm)	3-1/16" (78mm)	3-5/16" (84mm)	3-1/16" (78mm)	3-1/8" (80mm)	3-1/16" (78mm)	
<b>Victoria</b>	TT	TU	TW	TX	UX	TY	WG
							
Projection	2-11/16" (68mm)	3-1/4" (83mm)	3" (76mm)	3-5/8" (92mm)	3-7/16" (87mm)	3-5/16" (84mm)	3-5/8" (92mm)
<b>Niagara</b>	MA	RA	RB	RC			
							
Projection	2-13/16" (71mm)	3-11/16" (94mm)	2-13/16" (71mm)	2-13/16" (71mm)			

**Notes:**

Projection dimensions are provided using the 620F Series escutcheon plates.

The following Reflections levers are not available in 629 or 630 finish: Victoria TT, TU, TW, TX, TY, UX; Seine TG, TJ, TK, TE, TI; Hudson TD; Niagara CH, DW, MA, RA, RB, RC. Please consider the 618 or 619 finish as an alternative. Reflections levers are not available with knurling option.

## 7100 SERIES TRIMS

### 620F and 650F Series Escutcheon Trim



- Certified ANSI/BHMA A156.3, Grade 1.
- Trim thrubolts to exit device for strength.
- Beveled sides improve attack resistance.
- Solid forged escutcheon and Free-Wheeling trim resists vandalism and abuse.
- Flush cylinder in 6-pin applications for additional security.
- 1-3/4" (44mm) door standard. For doors through 2-1/4" (57mm) or shim-mounted devices, specify on order.
- Dimensions: 3" x 10-1/4" x 13/16" (76mm x 260mm x 19mm).
- Cylinders not included. See page 45-48 for cylinder options. 1-1/2" mortise cylinder required for mortise trim.
- Available with AR, AU, CR, JN, MO, PB, PN, VI and HA lever designs. See page 22.
  - Finishes: 605, 606, 611, 612, 613E, 619, 626, 629, 630, 693, BSP, WSP
- Available with Reflections® lever designs. See page 23.
  - Finishes: 605, 606, 611, 612, 613E, 619, 626, 629, 630, BSP, WSP
- Trim ordering example: AU626F x 626 x RHR.
- 5-year limited warranty.

Application	Cylinder	Classroom/ Storeroom Cylinder Controls Thumbturn	Exit Only Blank Plate	Nightlatch Access by Key	Classroom Cylinder Controls Lever	Storeroom Cylinder Controls Lever	Nightlatch Cylinder by Lever	Passage	Dummy Trim Free- Wheeling	Dummy Rigid Lever
7100(F) 7150(F) 7110(F) 7120(F) 7160(F) 7170(F)	Rim	603F <sup>1</sup>	620F	621F <sup>2</sup>	626F	626F <sup>1</sup>	627F <sup>2</sup>	628F	628F <sup>1</sup>	629F
7130(F)	Mortise	—	620F	651F	656F	—	656F	658F	—	658F
7100(F)-2 7150(F)-2	Rim x Rim	—	—	—	626F	—	—	—	—	—
7130(F)-2	Mortise x Rim	—	—	—	656F	—	—	—	—	—
ANSI		11/12	01	03	08	09	03	14	02	02

1. 09, 12 and Free Wheeling 02 achieved with single trim modification at installation.

2. Not recommended for use with vertical rod devices.

3. 08 only

For 626, 629 & 630 finishes the escutcheon is plated to simulate stainless steel.

For 629 & 630 finishes the standard levers are plated to simulate stainless steel.

Free-Wheeling is not available on mortise trim.

For 620F series trim, optional door thickness available up to 4-1/2", specify on order.

**7100 SERIES TRIMS**

**630F, 660F and 670F Series Pull/Thumbpiece Trim**



- Certified ANSI/BHMA A156.3, Grade 1.
- Trim thrubolts to exit device for strength.
- Beveled sides improve attack resistance.
- Flush cylinder in 6-pin applications for additional security.
- 1-3/4" (44mm) door standard. For doors through 2-1/4" (57mm) or shim-mounted devices, specify on order.
- Plate Dimensions: 2-3/4" x 15-1/2" x 5/8" (70mm x 394mm x 16mm).
- Pull Dimensions: 6-7/16" (164mm) on centers x 2-1/8" (54mm) projection.
- Cylinders not included. See page 49-52 for cylinder options. 1-1/2" mortise required for mortise trim.
- Finishes: 605, 606, 612, 613E, 619, 626, 629, 630, 693, BSP, WSP
- Trim ordering example: 630F x 630
- 5-year limited warranty.

Applications	Cylinder	Exit Only Blank Plate	Nightlatch Access by Key	Nightlatch Cylinder by Pull	Classroom Cylinder Controls T-Piece	Storeroom Cylinder Controls T-Piece	Dummy Trim Pull Plate	Passage Active T-Piece
7100(F) 7150(F) 7110(F) 7120(F) 7160(F) 7170(F)	Rim	630F	631F <sup>2</sup>	632F <sup>2</sup>	633F	633F <sup>1</sup>	634F	635F
7100(F)-2 7150(F)-2	Rim x Rim	—	—	—	633F	—	—	—
7130(F)	Mortise	630F K5F	661F K5F	662F K5F	673F <sup>3</sup> T8F	—	634F K5F	675F <sup>3</sup> T8F
7130(F)-2	Mortise x Mortise	—					—	—
ANSI		01	03	03	05	06	02	15

1. 06 achieved with single trim modification at installation.  
 2. Not recommended for use with vertical rod exit devices.  
 3. Available for 1-3/4" thick doors only.  
 For 630F series trim, optional door thickness available up to 4-1/2", specify on order.  
 For 626, 629 & 630 finishes the escutcheon is plated to simulate stainless steel.

## 7100 SERIES TRIMS

### 680F Series Offset Pull Trim



- 1-3/4" (44mm) door standard. For doors through 2-1/4" (54mm) or shim-mounted devices, specify on order.
- Plate Dimensions: 3" x 10-1/4" x 13/16" (76mm x 260mm x 21mm)
- Pull Dimensions: 7-1/4" (184mm) on centers x 2-13/32" (61mm) projection.
- Trim thrubolts to exit device for strength.
- Beveled sides improve attack resistance.
- Flush cylinder in 6-pin applications for additional security.
- Cylinders not included. See page 49-52 for cylinder options. 1-1/2" mortise cylinder required for mortise trim.
- Finishes: 605, 606, 611, 612, 613E, 619, 626, 629, 630, 693, BSP, WSP
- Trim ordering example: 681F x 630 x LHR
- 5-year limited warranty

Applications	Cylinder	Dummy Pull	Nightlatch Access by Key	
7100(F) 7150(F) 7110(F) 7120(F) 7160(F) 7170(F)	Rim	680F	681F*	—
7130(F) 7130(F)-2	Mortise	—	—	684F
ANSI	—	02	03	—

\*Not recommended for use with vertical rod exit devices.

For 626, 629 & 630 finishes the escutcheon is plated to simulate stainless steel.

## 7100 SERIES TRIMS

### 540F Series Rose Trim



- Certified ANSI/BHMA A156.3, Grade 1.
- 540F rose trim for stock doors.
- Trim thrubolts to exit device for strength.
- 1-3/4" (44mm) door standard. For doors through 2-1/4" (57mm) or shim-mounted devices, specify on order.
- AU, PB and MO trim designs. See below.
- Accepts cylindrical type cylinders. Cylinders included, see page 50 for cylinder options.
- Finishes: 605, 606, 612, 613E, 619, 625, 626, 693, BSP, WSP
- "B" trim prefix - Lever trim accepting all small format interchangeable cores. 6- or 7-pin (Example: B-AU546F)
- "M" trim prefix - Lever trim accepting Medeco® (32 series) and ASSA® large format interchangeable cores. Available in AU lever only. 6-pin only. (Example: M-AU546F)
- "S" trim prefix - Lever trim accepting Schlage® standard cylinders. 6-pin only. (Example: S-AU546F)
- "SI" trim prefix - Lever trim accepting Schlage® large format interchangeable cores. 6-pin only. (Example: SI-AU546F)
- Please specify when ordering 1210 LFIC prep.
- 3-year limited warranty.

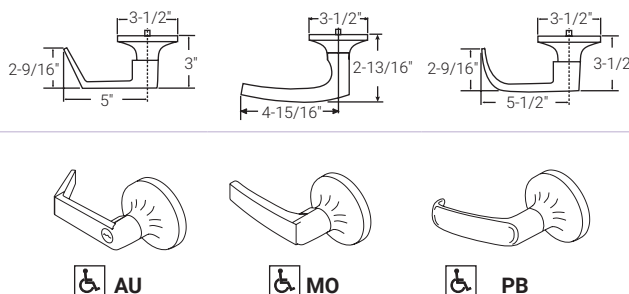

Applications	Nightlatch Access by Key	Classroom Cylinder Controls Lever	Passage Lever	Dummy Trim Free-Wheeling Lever	Dummy Trim Rigid Lever
7100(F), 7150(F), 7110(F), 7120(F), 7160(F), 7170(F)	541F*	546F	548F	548F	549F
ANSI	03	08	14	02	02







\*Not recommended for use with vertical rod devices.

**7200 & 7200M SERIES TRIMS**

**500F Series Escutcheon Trim**

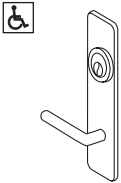

- Certified ANSI/BHMA A156.3, Grade 1.
- Trim thrubolts to exit device for strength.
- 1-3/4" (44mm) door standard. For doors through 2-1/4" (57mm) or shim-mounted devices, specify on order.
- Dimensions: 1-5/8" x 9-1/2" x 1/4" (41mm x 241mm x 6mm)
- Cylinders not included. See page 49 for cylinder options.
- Available with AR, AU, CR, JN, MO, PB, PN, VI and HA lever designs. See page 22.
  - Finishes: 605, 606, 611, 612, 613E, 619, 626, 629, 630, 693, BSP, WSP
- Available with Reflections® lever designs. See page 23.
  - Finishes: 605, 606, 611, 612, 613E, 619, 626, 629, 630, BSP, WSP
- Trim ordering example: AU506F x 626 x RHR.
- 1-year limited warranty.

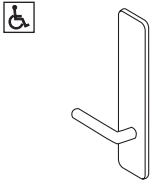
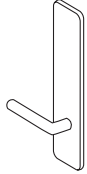
								
Applications	Nightlatch Access by Key	Exit Only Blank Plate	Nightlatch Access by Key	Classroom/Storeroom Cylinder Controls Thumbturn	Classroom/Storeroom Cylinder Controls Lever	Passage	Passage or Dummy	Dummy Trim
7200, 7210, 7220, 7250, 7200M(F), 7210M(F), 7220M(F), 7250M(F)	121NL <sup>2</sup>	500F	501F <sup>2</sup>	503F <sup>1</sup>	506F <sup>1</sup>	507F	508F <sup>1</sup>	509F
ANSI	03	01	03	11/12	08/09	16	14/02	02

<sup>1</sup> 09, 12 and Free-Wheeling 02 achieved with simple trim modification at installation.

<sup>2</sup> Not recommended for use with vertical rod devices.

For 629 & 630 finishes the standard levers are plated to simulate stainless steel.



## 7200 & 7200M SERIES TRIMS

### 510F Series Pull/Thumbpiece Trim



- Certified ANSI/BHMA A156.3, Grade 1.
- Trim thrubolts to exit device for strength.
- 1-3/4" (44mm) door standard. For doors through 2-1/4" (57mm) or shim-mounted devices, specify on order.
- Plate Dimensions: 1-5/8" x 15-1/4" x 5/8" (41mm x 387mm x 16mm).
- Pull Dimensions: 6-7/16" (164mm) on centers x 2-1/8" (54mm) projection.
- Accepts rim cylinders. Cylinders not included. See page 49 for cylinder options.
- Finishes: 605, 606, 611, 612, 613E, 619, 626, 629, 630, 693, BSP, WSP
- Trim ordering example: 512F x 630
- 1-year limited warranty.

Applications	Nightlatch Access by Key	Classroom/ Storeroom Cylinder Controls Thumbturn	Dummy Trim	Passage	Classroom/ Storeroom Cylinder Controls T-Piece	Passage
7200, 7210, 7220, 7250, 7200M(F), 7210M(F), 7220M(F), 7250M(F)	512F*	513F	514F	517F	518F	519F
ANSI	03	11/12	02	16	05/06	15

\*Not recommended for use with vertical rod devices.

### 121NL Cylinder Only

- Application: 7100(F) and 7150(F) rim and SquareBolt® exit devices. Not recommended for surface or concealed vertical rod devices.
- Must specify rim cylinder when ordering. See page 49 for cylinder options.
- Cylinder collar 1765.250 furnished standard for 1-3/4" thick doors.
- For 1109, 5109, K300, K640, A640 and 2109 cylinders:
  - Screw part number 34-2311-8738-048
  - Backplate part number 34-0010-1015-059
- For 1193, 5193 and K840 cylinders:
  - Screw part number 10-1193-1018-048
  - Backplate part number 34-0010-1015-059

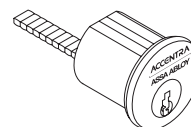

Function Description	Nightlatch Access by Key
Model No.	121NL
ANSI	03

## 7200 & 7200M SERIES TRIMS

### 480F Series Offset Pull Trim

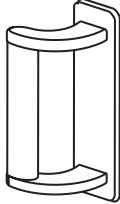
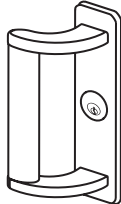

- 1-3/4" (44mm) door standard. For doors through 2-1/4" (57mm) or shim-mounted devices, specify on order.
- Plate Dimensions: 1-3/4" x L x 3/16" (44mm x L x 5mm) L = Overall plate length is 2-1/4" (57mm) longer than pull dimension.
- Pull Dimensions:
  - 480F and 481F trim have a 7-1/4" (184mm) pull length on centers which thru-bolts to exit device for strength.
  - 482F and 483F trim have a 9" (229mm) pull length on centers and are not to allow pulls of different lengths to be utilized. Longer lengths of 15" (381mm), 18" (457mm) and up to 30" (762mm) are available.
- 2-13/32" (61mm) projection.
- Cylinders not included. See page 49 for cylinder options.
- Finishes: 605, 606, 611, 612, 613E, 619, 626, 629, 630, 693, BSP
- Trim ordering example: 481F x 630 x LHR
- 1-year limited warranty

			
	Cylinder	Dummy Pull	Nightlatch Access by Key
7200, 7210, 7220, 7250, 7200M(F), 7210M(F), 7220M(F), 7250M(F)	Rim	480F 482F	481F* 483F*
ANSI	--	02	03

\*Not recommended for use with vertical rod exit devices.  
For 626, 629 & 630 finishes the escutcheon is plated to simulate stainless steel.

## ELECTRIFIED OPTIONS

The ASSA ABLOY ACCENTRA™ 7000 Series exit devices offer a complete range of electrical options. A continuity in appearance, security and functions with the 7000 Series mechanical exit device is maintained. These electrified exit devices may be integrated into the monitoring security and alarm systems of most buildings.

### Electrified Options

Model #	Exit Device Description	A	B	D	O	MELR	S	SAFE	SECURE	690F	691F
7100(F)	Rim Device (Wide)	x	x	x	x	x	x			x	x
7110(F)	Surface Vertical Rod (Wide)	x	x	x	x	x	x			x	x
7120(F)	Concealed Vertical Rod (Wide)	x	x	x	x	x	x				
7130(F)	Mortise Device (Wide)	x	x	x	x	x	x	x	x		
7150(F)	Rim SquareBolt® Device (Wide)	x	x	x	x	x	x			x	x
7150(F)WS	Rim SquareBolt Windstorm (Wide)	x	x		x	x	x			x	x
7160(F)	Concealed Vertical Rod (Wide)	x	x	x	x	x	x				
7170(F)	Surface Vertical Rod (Wide)	x	x	x	x	x	x			x	x
7170(F)WS	Surface Vertical Rod Windstorm (Wide)	x	x		x	x	x			x	x
7200(M)(F)	Rim Device (Narrow)	x	x	x		x	x				
7210(M)(F)	Surface Vertical Rod (Narrow)	x	x	x		x	x				
7220(M)(F)	Concealed Vertical Rod (Narrow)	x	x	x		x	x				
7250(M)(F)	Rim SquareBolt Device (Narrow)	x	x	x		x	x				

### Electrified Hardware Option Descriptions

A	Alarm Option
B	Touchbar Monitor or Signaling REX
D	Delayed Egress
O	Trim Monitor Switch
MELR	Motorized Electric Latch Retraction

S	Latchbolt Position Monitor
SAFE	Fail Safe Operation (Mortise)
SECURE	Fail Secure Operation (Mortise)
690F	Fail Safe Electrified Trim
691F	Fail Secure Electrified Trim

Note: Any combination of the following options cannot be ordered together:

- 1) MELR, A or D 2) B or A 3) D, B or A

What normally took an hour or more to connect now takes minutes. ASSA ABLOY ACCENTRA™ electrified exit devices and trims are equipped with ElectroLynx connectors. As a standard feature, these “plug & play” connectors link power from the incoming source to electrified locking products, including hinges, locks, exit devices, magnetic holders and strikes.

Note: Electrified door hardware with ElectroLynx connectors require a compatible number of lead wires attached to the door hinge.

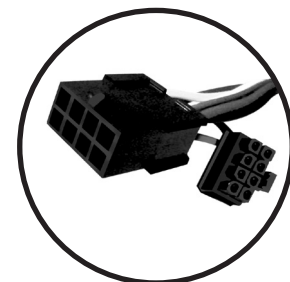

## ELECTRIFIED OPTIONS

### Motorized Electric Latch Retraction “MELR”

#### Operation

Allows the latchbolt to be retracted electrically for momentary or maintained periods of time from a remote location. The exit device bolt remains retracted for as long as the device is energized. Removal of power returns the device to the life safety, self-latching mechanical mode. Easy interface with central or local fire alarm systems, automatic door operators, hands-free actuation devices, and access control systems. Allows free egress at all times. Manual hex key dogging standard on non-rated devices. Not available on openings less than 30" wide.

#### Electrical Specifications

Motor Driven Latch Retraction

- 24VDC (BPS-24-1) regulated/filtered power supply. Requires 1A per device
- .65A amp max during retraction
- .2 amp holding-continuous duty

#### Listings

UL/cUL listed for panic and fire exit hardware. Fire-rated devices must be wired into an automatic fire alarm system.



#### Applications

Rim: 7100(F), 7200, 7200M(F)

SquareBolt®: 7150(F), 7250, 7250M(F)

SVR: 7110(F), 7170(F), 7210, 7210M(F)

CVR: 7120(F), 7160(F), 7220, 7220M(F)

Mortise: 7130(F)

#### Ordering

Suffix “MELR” to the Model Number. Ex: 7100MELR.

**Note: Not available on "A" alarm exit device and "D" delayed egress exit devices. Existing solenoid and mechanical devices can be retrofit to motorized electric latch retraction (MELR) by purchasing a retrofit kit, if the device was manufactured after April 2015.**

Model No.	Product Description	Available Options		
		WS	"O"	WS & "O"
RMELR-36	7100 36" MELR DEVICE ASSY	X	X	X
RMELR-38	7200 36" MELR DEVICE ASSY		X	
RMELR-48	7100 & 7200 48" MELR DEVICE ASSY	X	X	X

### Latchhead Requirements

Existing solenoid and mechanical devices manufactured prior to April 2015 require the device assembly retrofit kit (see above) and a new latchhead. Refer to the 7000 Series Parts & Service Manual for latchhead replacement part numbers.

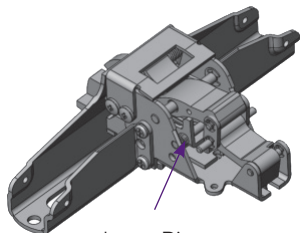
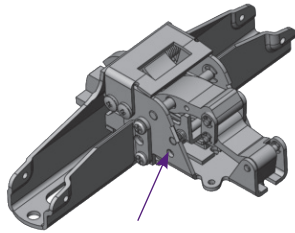
Latchhead Pins	Latchhead Pins
Since April 2015 (17/15)	Prior to April 2015 (17/15)
	
Long Pin	Short Pin

Note: Label with date code is located on front face of latch head.

#### Date Code Label Example

80-7710-0010-048

**AAO**

**17/15**

17/15 refers to 17th week of 2015.

## ELECTRIFIED OPTIONS

### Mortise Device Trim Control “Safe/Secure”

#### Operation

Allows the outside trim to lock or unlock electrically from a remote location. Exit device allows free egress at all times.

Fail Safe devices are commonly used in stair towers or locations that require the trim to unlock when power is removed or during fire alarm activation.

Fail Secure devices are used to secure openings and are usually integrated into the building security system to allow access control. Fail Secure trims remain locked when power is removed.

#### Electrical Specifications

Solenoid

- .35 amps @ 24VDC only (12 volt not available)
- Continuous duty
- Requires a 2-wire pivot or hinge and a standard 24VDC regulated and filtered power source (Recommended BPS power supplies)

#### Listings

UL/cUL listed for panic and fire exit hardware. 

#### Applications

Mortise: 7130(F) - lever functions only

#### Ordering

“Safe” – Maintains the outside trim in a locked state when energized. Removal of power unlocks outside trim.

“Secure” – Unlocks the outside trim when energized. Remains locked when power is removed.

Suffix “SAFE” or “SECURE” to the Model Number.

Ex: 7130 x L5 x Safe.

## ELECTRIFIED OPTIONS

### Delayed Egress "D"

#### Operation



An exit door is normally closed and latched. The delayed egress device secures the door in the locked mode with the Red LED indicating locked mode status. Depressing the pushpad for less than three seconds will cause the device to beep without initiating the alarm. Depressing the pushpad for three seconds or longer will initiate an irreversible local audible beeping tone and a visual amber indicator. The person depressing the pushpad is denied egress for 15 or 30 seconds while alarm signals unauthorized egress. After the factory-set delay time (15 or 30 seconds), the device releases for egress, the LED changes to Green and the beep changes to a steady tone which continues to alarm until reset. The remote monitoring contact outputs can be used to alert security personnel.

**Note: The 15-second time delay is standard. (Optional 30-seconds may be accepted by local jurisdiction.)**

#### Electrical Specifications

- Input Voltage 24VDC (+/- 10%)  
Power Consumption:
- Standard Device: 500 mA
- Device with Safe/Secure Electric Mortise or Electric Trim Control: 1.5 Amps.

#### Certifications & Listings

UL/cUL Listed: FUKD/FUKD7 - Controlled Exit Panic Devices   
FWAX/FWAX7 - Special Locking Arrangements  
GXHX/GXHX7 - Fire Exit Hardware  
ANSI/BHMA Certified: A156.3 & A156.24 

#### Applications

- For use on hollow metal interior or exterior doors.
- Available for 7100(F), 7200M(F) and 7200 series rim, SquareBolt®, surface vertical rod, concealed vertical rod and mortise panic and fire-rated exit devices. For surface vertical rod exit devices, rod and latch guards (provided by other) must be used.
- Complies with NFPA 101 "Code For Safety To Life From Buildings And Structures" by National Fire Protection Association.
- BOCA options available to comply with National Building Code requirements. BOCA option is not suitable for installations in accordance with NFPA 101.
- 1-3/4" door thickness standard; 2" and 2-1/4" optional; specify when ordering.
- Standard 36" device fits doors 35"- 36" Device cannot be cut less than 35".
- Option -48 fits doors 41"- 48". Devices cannot be cut less than 41".

#### Standard Features

##### Key Switch Operation:

- Normal: The system is armed by applying power to the device (solid Red LED). Depressing the pushpad for more than the nuisance delay time starts the exit delay cycle.



- Bypass: Turning the key switch clockwise to the bypass position allows immediate egress without alarming. The bar functions as a standard exit device (Red LED flashes slowly).
- Reset/Delay: Used to reset device after the factory-set 15 or 30-second delay cycle has timed out.
- Rearm: If the device is armed, turning the key counterclockwise to the reset mode will release the device without alarm for egress and will rearm after 10 seconds (Red LED flashes quickly).

##### Local Visual Status Indicator:

- RED: The exit device is secure and the delayed egress circuitry is energized.
- AMBER: The egress cycle has started, indicated by an irreversible local audible beeping tone.
- GREEN: The exit device is in alarm and has released.

##### Nuisance Delay Time:

- Depressing the pushpad for less than three seconds sounds an audible beep without activating the irreversible alarm sequence. (Immediate alarm can be selected by removing a jumper on the control board.) Nuisance Delay Times are dip switch selectable to Immediate, 1, 2, or 3 (default) seconds on the control board.

##### Internal Alarm Siren:

- When armed, depressing the pushpad initiates the internal 85db alarm siren.

##### Door Position Switch (DPS) Control Board input:

- Allows external DPS wiring to control board for higher security. Alarm sounds when the DPS contacts open when the door is forced open.

##### Remote Control Inputs:

- Remote Reset: Accepts a momentary contact (keyswitch, pushbutton, etc) to reset the unit during alarm or allows momentary egress (selectable 5, 10 (default), 20 or 40 seconds) when the unit is armed.
- Remote Bypass: Accepts a momentary contact to put the unit in a maintained bypass operation. The exit device functions as a standard device.

##### Alarm Outputs:

- Contacts change only during alarm status. One set of Alarm Relay Output contacts change state when device delay cycle has started (Alarm). Contacts are selectable for Normally Open (N.O.) or Normally Closed (N.C.) using the 2-pin jumper on the control board. N.O. is default setting. One set of contacts changes when device has released (Secure). Secure Relay Output has two sets of contacts (N.O. and N.C.). The Alarm Relay and Secure Relay contacts are SPDT type, rated 1A @24VDC.

##### Door Sign:

- Door sign per code included.

## ELECTRIFIED OPTIONS

### Delayed Egress “D” (cont.)

#### Rearm After Closing (RAC)

Works in conjunction with an external DPS wired to the Control Board. Field selectable settings:

#### Setting 1 :

If the door is open beyond the momentary egress or remote reset time the device will Alarm.

#### Setting 2:

If the door is open beyond the momentary egress or remote reset time the device will remain in egress mode indefinitely until the door closes (will not Alarm).

#### Options

##### Latchbolt Position Monitor “S”:

- Used to monitor the positions of the latchbolt or vertical rods (SPDT switch).
- To order, suffix “S”.
- See page 32 for more information.

##### Trim Monitor Switch “O”:

- Used when outside trim is desired. This switch will allow Bypass (disarms device) when the trim is used for ingress. The device will need to be reset upon entry by means of the keyswitch on the device or a remote switch.
- To order, suffix “O”.

#### NFPA 101 Requirements:

15- & 30-Second Delay

- Upon depressing the pushpad for 3 seconds, the delayed egress device will sound an audible beeping tone and allow the door to be opened after 15 (or 30) seconds. The tone will then change to a continuous alarm until reset. Resetting of the alarm and re-arming of the device is accomplished by manual means only.
- To order, specify NFPA 15-second or NFPA 30-second.
- Purchase orders that do not have an option noted will default to the NFPA 15-second delay.
- NOTE: Where approved by the authority having jurisdiction, a delay not exceeding 30 seconds shall be permitted.

### Required Accessories

#### Power Supply:

A regulated and filtered power supply with a fire alarm interface is required. 1 Amp minimum @ 24VDC per device. Special options will require more amperage. Consult factory. Recommend: BPS series.

#### Power Transfer:

Allows the power cable to make the transition from frame to door without pinching or removal of insulation.

#### BOCA Requirements:

15- & 30-Second Delay

- Upon depressing the pushpad for 1 second, the delayed egress device will sound an audible beeping tone and allow the door to be opened within 15 (or 30) seconds. The tone will then change to a continuous alarm until reset. Resetting of the alarm and re-arming of the device occurs automatically once the door has been returned to the closed position for 30 seconds. The 30-second re-arming timer will re-start if the pushpad is depressed or the door is re-opened before actual re-arming of the device occurs. A DPS (Door Position Switch) is required for the BOCA option.
- To order specify BOCA 15-second or BOCA 30-second.
- Purchase orders that do not have an option noted will default to the NFPA 15-second delay.
- NOTE: An increase in the egress delay to 30 seconds shall not be permitted except as approved by the authority having jurisdiction.

#### Electric Trim Control - “SAFE” or “SECURE”:

- The mortise delayed egress exit device can be ordered with fail safe or fail secure outside trim operation. In a fire condition the fail safe trim will release for entry. When access control is used the fail secure trim allows entry by means of a remote card reader, keyswitch, pushbutton, etc.
- To order, suffix “Safe” or “Secure”.
- NOTE: The trim will open the door without affecting the device in an armed condition, if a door position switch is not used.

#### Cylinders

Utilizes a 1-1/8” mortise cylinder with a 2160 cam. Cylinder not included unless specified. See page 45-48.

#### Ordering

Suffix “D” after device.

Example: 7150FD

ElectroLynx® Power Transfer Device Options		
Hinge	External DPS	Options
QC8	Not required	None
QC12	Required	S, or O, or Safe/Secure Options

Refer to McKinney Power Transfer Device catalog for ElectroLynx options.



## ELECTRIFIED OPTIONS

### Alarm Kit "A"

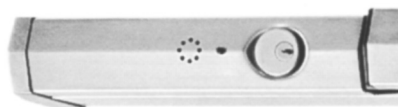

**Activation:** Alarm is armed by turning key clockwise. Low audible chirp indicates alarm has been activated. Alarm will sound when the exit device pushpad is depressed. Factory preset for standard alarm mode which automatically resets after 5 minutes.

**Continuous Alarm Mode:** Alarm sounds continuous when the exit device pushpad is depressed. Alarm must be manually reset by keyswitch. (This feature is selected by a switch on the circuit board.)

**Low Battery Warning:** Audible chirp.

**Nuisance Alarm:** Factory preset for instant alarm. Selectable feature for alarm to sound when pushpad is depressed for more than 2 seconds. (This feature is selected by a switch on the circuit board.)

**Arming Delay/Authorized Egress:** 10-second delay (after arming) permitting egress (by turning key clockwise).

**Alarm Shunt:** Ingress shunt alarm input for devices with latchbolt position (S) monitor. NOTE: "S" included with SVR devices.

**Power Requirements:** One 9-volt battery (included).

**Loudness:** 90db @ 10 feet.

**Arm/Disarm:** Uses one 1-1/8" straight cam mortise cylinder. Clockwise turn arms the alarm, counter clockwise turn disarms or silences the alarm.

**Device Status:** A Red LED indicator will illuminate every 30 seconds when the alarm is armed.

**Tamper Resistant:** Built-in safety monitor sounds alarm when tampering occurs.

**Warning Decal:** "EMERGENCY EXIT - ALARM WILL SOUND"

**Applications:** Rim: 7100(F), 7200, 7200M(F); SquareBolt®: 7150(F), 7250, 7250M(F); SVR: 7110(F), 7170(F), 7210, 7210M(F); CVR: 7120(F), 7160(F), 7220, 7220M(F); Mortise: 7130(F)

**Kit:** Available in kit form for field retrofit.

**Bar Length:** Available for 36"- 48" devices only. May not be used on bars less than 36".

- Standard 36" device fits doors 35"-36" Device cannot be cut less than 35".

- Option -48 fits doors 41"- 48". Devices cannot be cut less than 41".

**How to Order:** Specify 7116 for alarm kit. Suffix "-A" when ordering with device. Ex: 7150-A.

**NOTE:** The 7116 alarm kit cannot be retrofitted in the field to the 7110(F), 7170(F), 7210 or 7210M(F) surface vertical rod exit devices. This option is available as a factory order only for these devices. Any attempt to retrofit the 7116 alarm kit with these surface vertical rod exit devices will void the warranties for these products.

### Electric Trim

The electrified 600 series heavy-duty trim provides electric locking and unlocking of trim. Ideal for door control where increased security is necessary at all times, while meeting life safety codes. Electric trim is ideal for many applications, including stairwell towers, high-security areas, schools, hospitals, and factories.



#### Functions

##### 690F Trim - Fail Safe

- Lever is locked when power is on (Free-Wheeling)
- Power off allows entry from trim
- Inside device is always active for egress
- Mechanical key override (09 Function - Key allows lever to retract latchbolt. Key can only be removed in locked position)

##### 691F Trim - Fail Secure

- Lever is locked when power is off (Free-Wheeling)
- Power on allows lever activation for entry
- Inside device is always active for egress
- Mechanical key override (09 Function - Key allows lever to retract latchbolt. Key can only be removed in locked position.)

#### Features

- Accepts all standard and Reflections® decorative lever designs
- Plug connector with 4' wire lead (Exit device is used as wire raceway, not door)
- Key Override - Requires rim cylinder (sold separately)

#### Applications

- 7100(F) Rim Device
- 7150(F) SquareBolt®
- 7110(F), 7170(F) Surface Vertical Rod

#### Electrical Specifications

- 330 mA @ 24 Volts
- SM - Security Monitor Switch
- 4 AMP @ 250VAC
- Voltage: 24 VAC/VDC only
- BPS series power supplies recommended.

#### Options

- SM - Security Monitor. A SPDT switch that monitors the position of the solenoid (lock and unlock status).
- EX - Trim gasket for exterior applications.

#### Hard Wired Option

A hard wired option is available by using a 9VDC output power supply and a remote power harness. Specify 784 to order the 9VDC output power supply. See page 39 for 784 power supply information. Specify WH-11 to order the remote power harness for a 36" device and specify WH-12 to order the remote power harness for a 48" device.



## ELECTRIFIED OPTIONS

### Touchbar Monitor “B”

Provides indication of the pushpad being depressed. Used as a Request to Exit switch to shunt alarm systems, release electromagnetic locks or monitor egress.

**Electrical Specifications:**

2A @ 28VDC  
SPDT contacts

**Listings:** UL/cUL listed for panic and fire exit hardware. 

**Applications:** Rim: 7100(F), 7200, 7200M(F)  
SquareBolt®: 7150(F), 7250, 7250M(F)  
SVR: 7110(F), 7170(F), 7210, 7210M(F)  
CVR: 7120(F), 7160(F), 7220, 7220M(F)  
Mortise: 7130(F)

**Ordering:** Suffix “B” to the Model Number. Ex: 7120B.

Note: Not available on “D” Delayed Egress devices or with the “A” Alarm kit option.

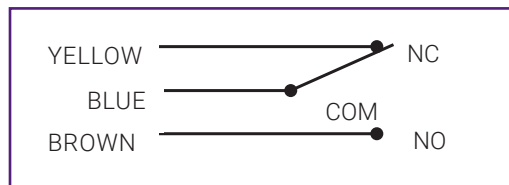

### Latchbolt Position Monitor “S”

Provides indication on the position of the latchbolt. Used with security systems to monitor the latchbolt, also used to activate automatic door operators upon latch retractions.

**Electrical Specifications:**

2A @ 28VDC  
SPDT contacts

**Listings:** UL/cUL listed for panic and fire exit hardware. 

**Applications:** Rim: 7100(F), 7200, 7200M(F)  
SquareBolt®: 7150(F), 7250, 7250M(F)  
SVR: 7110(F), 7170(F), 7210, 7210M(F)  
CVR: 7120(F), 7160(F), 7220, 7220M(F)  
Mortise: 7130(F)

**Ordering:** Suffix “S” to the Model Number. Ex: 7120S.

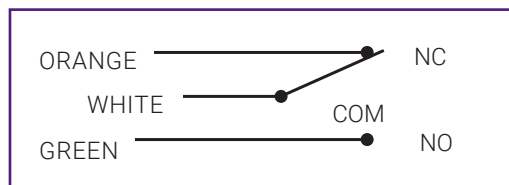

### Trim Monitor Switch “O”

Provides indication of the trim being operated from the outside. Used as a Request to Enter signal switch to shunt alarms, also used to monitor entry.

**Electrical Specifications:**

2A @ 28VDC  
SPDT contacts

**Listings:** UL/cUL listed for panic and fire exit hardware. 

**Applications:** Rim: 7100(F)  
SquareBolt®: 7150(F)  
SVR: 7110(F), 7170(F)  
CVR: 7120(F), 7160(F)  
Mortise: 7130(F)

**Ordering:** Suffix “O” to the Model Number. Ex: 7150O.

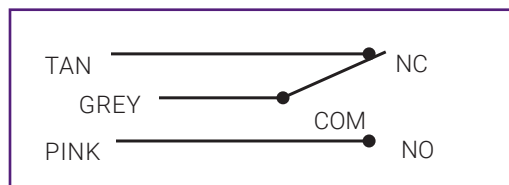

## ELECTRIFIED OPTIONS

### Stand Alone Door Alarm SDA16

The SDA16 stand-alone battery operated door alarm is designed to continually monitor the status of a door. When the door is opened without authorization, an alarm is triggered to alert the security violation. This alarm features a Piezo horn which blasts a deafening 105+ decibels to alert the violation.



This unit is ideal for emergency doors as well as stairwell doors and rear exit doors in retail environments. The unit, which can also be hardwired, easily complements existing hardware, making any opening alarmed. The SDA16 door alarm is typically mounted on the interior of the door frame or door and is paired with a magnet mounted on the opposing side of the door gap.

### Features

- Dimensions: 8.3"L x 3.1"W x 2.0"D (210mm L x 79mm W x 52mm D)
- Non-handed unit (field reversible)
- Unit powered by 9V battery
- Unit can be hardwired by using WH-11 wire harness and 784 power supply
- No battery is required in unit with hard-wire option – if power is lost, optional gel-cell battery in power supply will give approximately 10,000 operations
- Reverse battery protection safeguards the unit if the battery is incorrectly installed
- A low-voltage battery is indicated by an audible signal every 30 seconds
- Piezo horn blasts at 105+ decibels if the door is used without proper authorization
- The LED will flash every 30 seconds, indicating either the unit is armed or, if under auto reset, that the door has been violated
- Various field-adjustable features by dip switch including automatic alarm reset, REX and passage time delay, and LED color preference
- A tamper switch provides instantaneous signal to sound horn in the event the cover is removed. Horn will sound until the unit is reset by the key or remote reset/arm switch
- Conformally coated electronics for weather resistance
- Cover is held in place by cam lock which protects mounting screws, electrical system and internal sensors
- Accepts external cylinder (not included, must be specified)
- Accepts standard mortise cylinders (not included, must be specified)

### Remote Mounting

The SDA16 can be installed remotely from the door by attaching the contacts to the door and frame. The unit can be installed up to 6 feet from the door. This provides the ideal solution for circumstances where exposure to weather may be an issue. To order specify "SDA16XL".

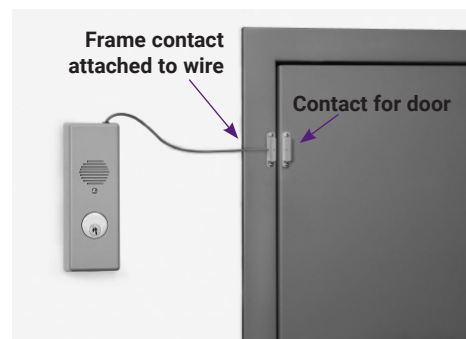

Note: Actual wire length is 6 feet.

### Cylinders and Accessories

- 784 Power supply (9VDC) – includes plug-in wall transformer
- Plug-in wall transformer with 12' cable assembly (part no. 00-0000-3425)
- Gel-cell battery – optional for use with 784 power supply (part no. 00-0000-3426)
- WH-11 Wire harness for remote power and remote unlock
- Mortise cylinder for unit
- Rim cylinder for outside control
- See pages 49-52 for cylinder information.

## ELECTRIFIED OPTIONS

### 782 Power Control



#### Operation

Designed to control one or two electric latch retraction “P” exit devices. Equipped with two 20-second timers which can operate the exit devices together or independently. Requires a momentary or timed, dry contact input and can be interfaced with access control systems, automatic door operators, “blow open” type scenarios and has provisions for N/C fire alarm systems. Note: The 782 is required for use with the “P” latch retraction option. Using any other power supply with the “P” option voids the warranty of the device.

#### Features

- Two control inputs. Accepts normally closed dry contacts for device activation from a key switch, push button, access control or fire alarm system.
- Two normally open control outputs for automatic door operators
- Two “P” device outputs
- Fire Alarm Interface input
- 24VDC output for audible or LEDS .25 AMP

#### Electrical Specifications

- 120 VAC 60Hz 750mA (max.)
- Not available in 240V
- 38-42 VDC output
- 10 amp inrush

#### Listings

- UL 294
- UL CLASS 2 outputs

#### Applications

“P” Electric Latch Retraction Option (not required with standard MELR option)

#### Ordering

782 Controller

ASSA ABLOY ACCENTRA™ recommends McKinney®, Pemko and Securitron® for power transfer devices and other electronic accessories.

### BPS Power Supplies By Securitron®

#### Operation

Power supplies are designed to provide reliable filtered and regulated power for long life to a variety of electrified hardware components.

#### Product Features

- Individual output circuit breakers
- Regulated and filtered fuse protected outputs
- LEDs monitor zone status (voltage or no voltage)
- Slide switches connect or disconnect load from power (Not available on 1 Amp supplies)
- Internal Back-Up battery charging circuit
- Rugged steel enclosure
- Fire alarm interface

#### Listings

- UL CLASS 2 

#### Applications (use with):

- D – Delayed Egress
- Safe – Fail Safe mortise device trim control
- Secure – Fail Secure mortise device trim control
- 690/691 – Electric Trim
- MELR

#### Ordering

Ex: BPS-24-4

Model	Input	Output	Application
BPS-24-1	120 VAC	1 Amp @ 24 VDC	1 “D”
BPS-24-2	120 VAC	2 Amp @ 24 VDC	2 “D” or 1 “D” with Safe or Secure
BPS-24-4	120 VAC	4 Amp @ 24 VDC	4 “D” or 3 “D” with Safe or Secure

Consult factory for additional power supply applications.

### 784 Power Supply

#### Features

- Provides a filtered and regulated 9 VDC remote power
- Requires raceway through the door\*

#### Includes:

- Plug-In Wall Transformer with approximately 12” (3.6m) of shielded wire that provides input power to the power supply
- Includes 12’ (3.6m) of shielded wire for connection between power transfer and power supply

\*Recommended for new opening. Retrofit application may require surface mounted wire mold and transfer loop by others.

## ELECTRIFIED SYSTEM GUIDE

### Motorized Electric Latch Retraction

Motorized Electric Latch Retraction Interfaced with an Automatic Door Operator

#### Components

- 7100MELR Latch Retraction
- Automatic Door Operator by Norton®
- ADA Pushbuttons #671 by Norton
- QC8 Power Transfer Hinge by McKinney®
- 700 Wave to Open Switches by Norton

#### Operation

Exit device allows free egress at all times.

Activating the interior or exterior pushbutton retracts the latchbolt in the device and the door automatically opens. Door closes and relatches after hold open time has elapsed in the operator.

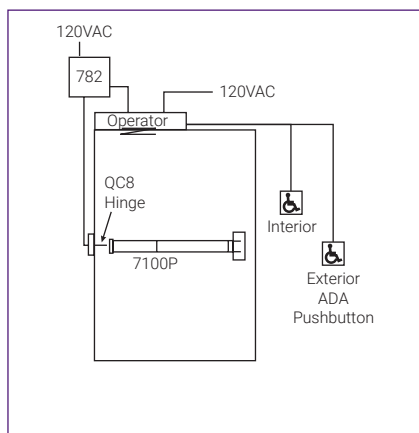

### Electric Dogging

Electric Dogging with Monitor Functions

#### Components

- 7100GBS Electric Dogging Device with Touchbar Monitor
- BPS Power Supply with fire alarm interface
- Keyswitch with a Red and a Green LED
- DPS (door position switch) by Securitron®
- QC12 Power Transfer Hinge by McKinney®

#### Operation

Exit device allows free egress at all times.

Activating the maintained keyswitch applies power to the 7100GBS device. The first mechanical depression of the pushpad will retract the latchbolt and hold the pushpad down in a dogged position. Fire alarm activation, interruption of power or turning the keyswitch off will release the pushpad and the latch will extend.

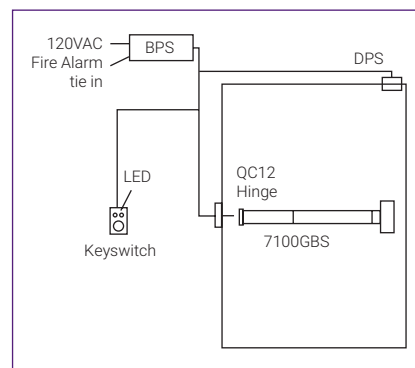

- The Green LED illuminates when power is on, and the pushpad can be depressed and dogged.
- The Red LED illuminates when power is off, the door is closed and the device is latched and secure.

### Monitor Functions

Motorized Electric Latch Retraction with Monitor Functions

#### Components

- 7100MELRBOS, Exit Device with Touchbar, Outside Trim and Bolt Position Monitors
- Momentary Pushbutton with Red and Green LED
- DPS (door position switch) by Securitron®
- TSB-C Door Cord by Securitron®

#### Operation

Exit device allows free egress at all times.

Activating the 402 x L2 push button retracts the latchbolt from a remote location.

- The Red LED indicates that the door is closed and latched.
- The Green LED illuminates when any of the following situations occur:
  - The pushpad is depressed
  - Tampering or retraction of the latchbolt
  - Operation of outside trim
  - Opening of door

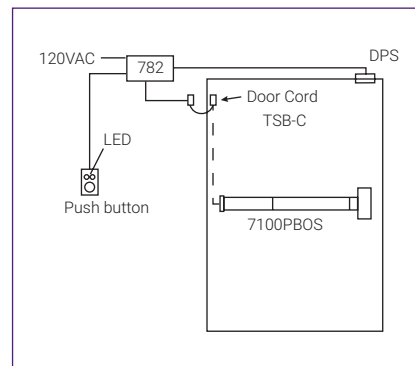

## ELECTRIFIED SYSTEM GUIDE

### Monitor Functions

#### Rim Exit Device with High Security Application

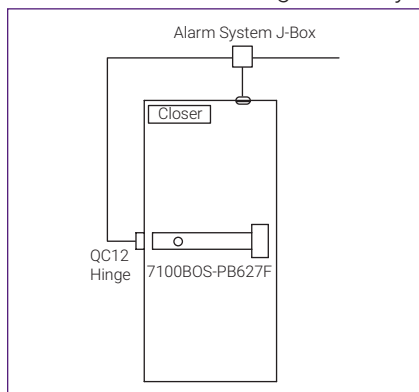

#### Components

- 7100 - PB627F Nightlatch Trim - ASSA ABLOY ACCENTRA™
- S Bolt Position Monitor Switch
- B Pushpad Monitor Switch
- O Trim Monitor Switch
- Door Position Switch - Securitron®
- QC12 Power Transfer Hinge by McKinney®
- Surface Door Closer - ASSA ABLOY ACCENTRA™

#### Operation

Operation of the 7100 Exit Device with the S, B, O and ASSW-104A can be used together or individually to sound an alarm, shunt an alarm, monitor the door's security or as a "Request to Exit" in conjunction a magnetic lock.

### Delayed Egress

#### Rim Exit Device with Delayed Egress Option on "Exit Only" Door

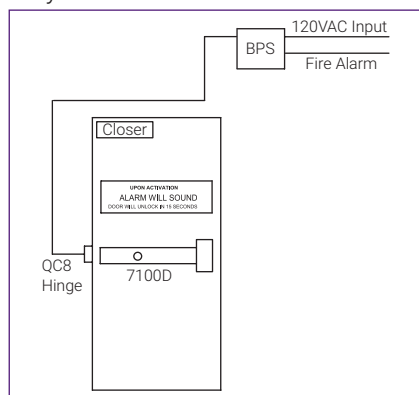

### Electric Trim

#### Rim Exit Device with Electrified Trim

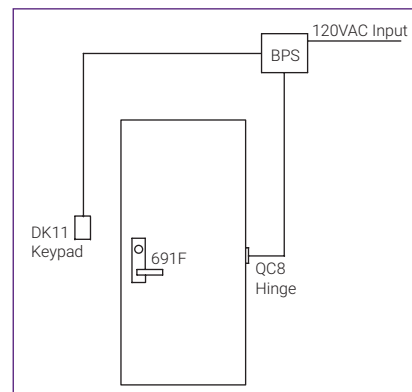

#### Components

- 691F Electrified Trim - ASSA ABLOY ACCENTRA™
- 7100 Rim Exit Device - ASSA ABLOY ACCENTRA™
- Digital Keypad by Securitron®
- QC8 Power Transfer Hinge by McKinney®
- BPS Power Supply

#### Operation

Operation of the Digital Keypad will allow keyless entry from the non-protected side of the opening. When a valid code is entered into the keypad, voltage will be applied to the trim, making the lever active and allowing ingress. Free exit is allowed by using the exit device from the protected side of the door.

#### Components































- 7100D Delayed Egress Exit Device - ASSA ABLOY ACCENTRA™
- QC8 Power Transfer Hinge by McKinney®
- BPS Power Supply
- Surface Door Closer - ASSA ABLOY ACCENTRA™

#### Operation

Operation of the 7100D Exit Device will sound an alarm and activate either a 15- or 30-second alarm sequence inside of the exit device. After this time period, the device will release the pushpad, making it active and egress is possible. When the fire alarm is activated, power to the exit device will be interrupted, allowing free egress and mechanical latching. Authorized alarm bypass and reset is done through the built-in keyswitch located in the exit device.



## FUNCTIONS

### Lever Trims









































SquareBolt® 7150(F) 7250 7250M(F) Inside Outside	Rim 7100(F) 7200 7200M(F) Inside Outside	Surface Vertical Rod		Concealed Vertical Rod		Mortise 7130(F)		Type	ANSI Function No.	Function Description
		7110(F) 7170(F) 7210 7210M(F) Inside Outside	7120(F) 7160(F) 7220 7220M(F) Inside Outside	Inside	Outside	Inside	Outside			
					Exit Only/ Blank Plate	01 -	Exit only, no trim. Exit only, blank plate.			
					Dummy	02	Entrance by trim when actuating bar is locked down.			
					Nightlatch	03	Entrance by trim when latchbolt is retracted by key. Key removable only when locked.			
					Classroom	08	Entrance by lever. Key locks or unlocks lever.			
					Storeroom	09	Entrance by lever only when released by key. Key removable only when locked.			
					Passage	14	Entrance by trim when latchbolt is released by lever. Lever always active, no cylinder.			

Note: 09 and Free-Wheeling 02 achieved with a single modification at installation.

### Double Cylinder Exit Device Lever Trims

SquareBolt® 7150(F)-2 Inside Outside		Rim 7100(F)-2 Inside Outside		Mortise 7130(F)-2 Inside Outside		Type	ANSI Function No.	Function Description
								

**FUNCTIONS**





<b>SquareBolt®</b> 7150(F) 7250 7250M(F) Inside Outside	<b>Rim</b> 7100(F) 7200 7200M(F) Inside Outside	<b>Surface Vertical Rod</b> 7110(F) 7170(F) 7210 7210M(F) Inside Outside	<b>Concealed Vertical Rod</b> 7120(F) 7160(F) 7220 7220M(F) Inside Outside	<b>Mortise</b> 7130(F) Inside Outside	<b>Type</b>	<b>ANSI Function No.</b>	<b>Function Description</b>
					Exit Only/ Blank Plate	01 -	Exit only, no trim. Exit only, blank plate.
					Dummy/ Pull Plate	02	Entrance by trim when actuating bar is locked down.
					Nightlatch	03	Entrance by trim when latchbolt is retracted by key. Key removable only when locked.
					Classroom	05	Entrance by thumbpiece. Key locks or unlocks thumbpiece.
					Storeroom	06	Entrance by thumbpiece only when released by key. Key removable only when locked.
					Passage	15	Entrance by trim when latch is released by thumbpiece. Thumbpiece is always active, no cylinder.
					Classroom	11	Entrance by control turn piece. Key locks or unlocks control.
					Storeroom	12	Entrance by control turn piece only when released by turning key. Key removable only when locked.

## APPLICATIONS

### 7100 Series

The 7100 is the perfect choice for wide stile panic and fire-rated applications. The smooth architectural lines provide pleasing aesthetics to accent a building's appearance, and looks aren't always deceiving. Beneath the strong exterior lie the components to meet the demanding security and access control needs of today. The delayed egress option is just one of the many electromechanical options offered to enhance security. Complementing the 7100 series with the 600F series heavy-duty trim completes the package for a heavy-duty, security hardware package.

### Applications

Single Door	UL Listing	Maximum Opening	Application	
<b>SquareBolt®</b>				
7150/7150-2	Panic	4' x *	Surface applied; single-point latching.	
7150F/7150F-2	3 Hr.	4' x 8'		
7150WS	Panic	4' x 8'	Surface applied; single-point latching. Used as components in swinging door windstorm-rated assemblies (refer to local codes).	
7150FWS	3 Hr.	4' x 8'		
<b>Rim</b>				
7100/7100-2	Panic	4' x *	Surface applied; single-point latching.	
7100F/7100F-2	3 Hr.	4' x 8'		
<b>Mortise</b>				
7130/7130-2	Panic	4' x *	Mortised in door; single-point latching.	
7130F/7130F-2	1-1/2 Hr.	4' x 9'		
7130F/7130F-2	3 Hr.	4' x 8'		
<b>Surface Vertical Rod</b>				
7110	Panic	4' x 8'	Surface applied; two-point latching.	
7170	Panic	4' x 10'		
7170 x LBR	Panic	4' x 10'	Surface applied; one-point latching.	
7170WS	Panic	4' x 8'	Surface applied; two-point latching. Used as components in swinging door windstorm-rated assemblies (refer to local codes).	
<b>Concealed Vertical Rod</b>				
7120	Panic	4' x 8'	Rods concealed in door; two-point latching.	
7160	Panic	4' x 10'		
7160 x LBR	Panic	4' x 10'		

\*UL does not set a door height limitation on panic applications.

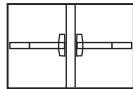
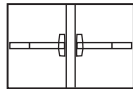
Pair of Doors with Removable Mullion	UL Listing	Maximum Opening	Application	
<b>SquareBolt® x SquareBolt®</b>				
7150 x 7150 x M200 Series	Panic	8' x 10'	Two independent active doors with removable mullion.	
7150F x 7150F x M200F Series	3 Hr.	8' x 8'		
7150WS x 7150WS x M200FWS	Panic	8' x 8'	Two independent active doors with removable mullion. Used as components in swinging door windstorm-rated assemblies (refer to local codes).	
7150FWS x 7150FWS x M200FWS	3 Hr.	8' x 8'		
<b>Rim x Rim</b>				
7100 x 7100 x M200 Series	Panic	8' x 10'	Two independent active doors with removable mullion.	
7100F x 7100F x M200F Series	3 Hr.	8' x 8'		



## APPLICATIONS

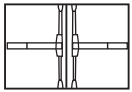
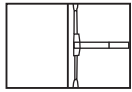
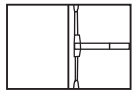
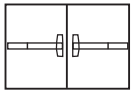
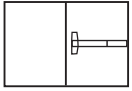

Pair of Doors	UL Listing	Maximum Opening	Application	
<b>Surface Vertical Rod</b>				
7110 x 7110	Panic	8' x 8'	Two independent doors with two-point latching, swinging in the same direction.	
7110F x 7110F	3 Hr.	8' x 8'		
7170 x 7170	Panic	8' x 10'	Two independent doors with one- or two-point latching, swinging in the same direction.	
7170F90 x 7170F90	1-1/2 Hr.	8' x 10'		
7170F x 7170F	3 Hr.	8' x 8'	Two independent doors with two-point latching, swinging in opposite directions. Used as components in swinging door windstorm-rated assemblies (refer to local codes).	
7170WS x 7170WS	Panic	8' x 8'		
7170FWS x 7170FWS	1-1/2 Hr.	8' x 8'		
<b>Surface Vertical Rod (Double Egress)</b>				
7110 x 7110	Panic	8' x 8'	Two independent doors with two-point latching, swinging in opposite directions. Overlapping astragal required for 3-hour openings.	
7110F x 7110F	3 Hr.	8' x 8'		
7170 x 7170	Panic	8' x 10'	Two independent doors with one- or two-point latching, swinging in opposite directions. Overlapping astragal not required.	
7170F90 x 7170F90	1-1/2 Hr.	8' x 10'		
7170F x 7170F	3 Hr.	8' x 8'		
<b>Surface Vertical Rod x Mortise</b>				
7110 x 7130	Panic	8' x 8'	Overlapping astragal required for 3-hour openings. Coordinator required with standard ANSI strike.	
7110F x 7130F	3 Hr.	8' x 8'		
7110F x 7130F x Open Back Strike	1-1/2 Hr.	8' x 8'	Overlapping astragal required for fire-rated openings. Coordinator required with standard ANSI strike.	
7170 x 7130	Panic	8' x 10'		
7170F90 x 7130F	1-1/2 Hr.	8' x 9'		
<b>Concealed Vertical Rod</b>				
7120 x 7120	Panic	8' x 8'	Two independent metal doors with two-point latching, swinging in the same direction.	
7120F x 7120F	3 Hr.	8' x 8'		
7160 x 7160	Panic	8' x 10'	Two independent metal or wood doors with one- or two-point latching, swinging in the same direction.	
7160F90 x 7160F90	1-1/2 Hr.	8' x 10'		
7160F x 7160F	3 Hr.	8' x 8'		
<b>Concealed Vertical Rod (Double Egress)</b>				
7120 x 7120	Panic	8' x 8'	Two independent metal doors with two-point latching, swinging in opposite directions. Overlapping astragal required for 3-hour openings.	
7120F x 7120F	3 Hr.	8' x 8'		
7160 x 7160	Panic	8' x 10'	Two independent metal or wood doors with one- or two-point latching, swinging in opposite directions. Overlapping astragal not required.	
7160F90 x 7160F90	1-1/2 Hr.	8' x 10'		
7160F x 7160F	3 Hr.	8' x 8'		

## APPLICATIONS

### 7200 Series

7200 Series narrow stile exit devices are designed for aluminum openings and are compatible with the aesthetics and functional requirements of contemporary glass doors. The device features lines chosen by leading architects and is available with the proven SquareBolt® exit device for increased security.

### Applications

Single Door	UL Listing	Maximum Opening	Application	
<b>SquareBolt®</b>				
7250	Panic	4' x *	Surface applied; single-point latching.	
<b>Rim</b>				
7200	Panic	4' x *	Surface applied; single-point latching.	
<b>Surface Vertical Rod</b>				
7210	Panic	4' x 10'	Surface applied; two-point latching.	
<b>Concealed Vertical Rod</b>				
7220	Panic	4' x 10'	Rods concealed in door; two-point latching.	

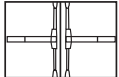
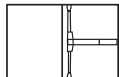
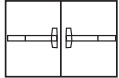
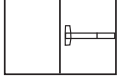
Pair of Doors	UL Listing	Maximum Opening	Application	
<b>Surface Vertical Rod</b>				
7210 x 7210	Panic	8' x 10'	Two independent doors with two-point latching, swinging in the same direction.	
<b>Surface Vertical Rod (Double Egress)</b>				
7210 x 7210	Panic	8' x 10'	Two independent doors with two-point latching, swinging in opposite directions.	
<b>Concealed Vertical Rod</b>				
7220 x 7220	Panic	8' x 10'	Two independent metal doors with two-point latching, swinging in the same direction.	
<b>Concealed Vertical Rod (Double Egress)</b>				
7220 x 7220	Panic	8' x 10'	Two independent metal doors with two-point latching, swinging in opposite directions.	

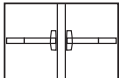
Pair of Doors with Removable Mullion	UL Listing	Maximum Opening	Application	
<b>SquareBolt® x SquareBolt®</b>				
7250 x 7250 x M300	Panic	8' x 10'	Two independent active doors with removable mullion.	
<b>Rim x Rim</b>				
7200 x 7200 x M300	Panic	8' x 10'	Two independent active doors with removable mullion.	

## APPLICATIONS

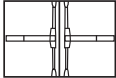
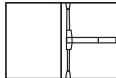
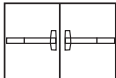
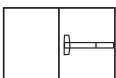
Pair of Doors	UL Listing	Maximum Opening	Application	
<b>Surface Vertical Rod</b>				
7210M x 7210M	Panic	8' x 10'	Two independent doors with two-point latching, swinging in the same direction.	
7210MF x 7210MF	3 Hr.	8' x 8'		
<b>Surface Vertical Rod (Double Egress)</b>				
7210M x 7210M	Panic	8' x 10'	Two independent doors with two-point latching, swinging in opposite directions.	
7210MF x 7210MF	3 Hr.	8' x 8'		
<b>Concealed Vertical Rod</b>				
7220M x 7220M	Panic	8' x 10'	Two independent metal doors with two-point latching, swinging in the same direction.	
7220MF x 7220MF	3 Hr.	8' x 8'		
<b>Concealed Vertical Rod (Double Egress)</b>				
7220M x 7220M	Panic	8' x 10'	Two independent metal doors with two-point latching, swinging in opposite directions.	
7220MF x 7220MF	3 Hr.	8' x 8'		





\*UL does not set a door height limitation on panic applications.

## APPLICATIONS

### 7200M Series

The 7200M series combines the appearance of the 7200 narrow stile series with the life safety and fire rating options of the 7100 series. This unique narrow design exit device may be used on wide or flush stile doors and is available with a wide range of mechanical and electromechanical options including, electric latch pullback and monitoring features. The 7200M series is not to be used on narrow stile applications.

### Applications

Single Door	UL Listing	Maximum Opening	Application	
<b>SquareBolt®</b>				
7250M	Panic	4' x *	Surface applied; single-point latching.	
7250MF	3 Hr.	4' x 8'		
7250MWS	Panic	4' x 8'		
7250MFWS	3 Hr.	4' x 8'		
<b>Rim</b>				
7200M	Panic	4' x *	Surface applied; single-point latching.	
7200MF	3 Hr.	4' x 8'		
<b>Surface Vertical Rod</b>				
7210M	Panic	4' x 10'	Surface applied; two-point latching.	
<b>Concealed Vertical Rod</b>				
7220M	Panic	4' x 10'	Rods concealed in door; two-point latching.	

\*UL does not set a door height limitation on panic applications.

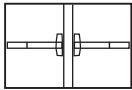
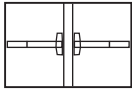
Pair of Doors with Removable Mullion	UL Listing	Maximum Opening	Application	
<b>SquareBolt® x SquareBolt®</b>				
7250M x 7250M x M200	Panic	8' x 10'	Two independent active doors with removable mullion.	
7250MF x 7250MF x M200F	3 Hr.	8' x 8'		
7250MWS x 7250MWS x M200FWS	Panic	8' x 8'	Two independent active doors with removable mullion. Used as components in swinging door windstorm-rated assemblies (refer to local codes).	
7250MFWS x 7250MFWS x M200FWS	3 Hr.	8' x 8'		
<b>Rim x Rim</b>				
7200M x 7200M x M200	Panic	8' x 10'	Two independent active doors with removable mullion.	
7200MF x 7200MF x M200F	3 Hr.	8' x 8'		

**CYLINDERS**

**Rim**

The following chart details rim cylinders for use with 480F, 500F, 510F, 620F, 680F, 630F, 121NL trims and outside of SDA16 door alarm:

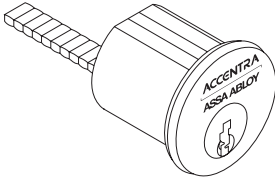
				Collar Requirements*				
				480F/500F/510F	620F/680F	630F	121NL	SDA16 Outside
Model #	Description	Pins	Length					
1109	Standard Fixed Core	6	1-1/4"	599.419	No Collar	No Collar	1765.250	1765.250
1109	Standard Fixed Core	7	1-7/16"			KP4		
1709	CMK	6	1-15/16"	599.544	1765.250	1765.250		
1709	CMK	7	1-5/8"			1765.406		
1193	LFIC Complete	6	1-7/16"	599.544		1765.250		
1193	LFIC Complete	7	1-5/8"	599.700	1765.344	1765.406		
5109	Security Fixed Core	6	1-9/16"	599.419	No Collar	1765.250		
5109	Security Fixed Core	7	1-7/16"					
U5109	High Security Fixed Core	6	1"	NA	No Collar	No Collar	No Collar	No Collar
U5109	High Security Fixed Core	7	1"					
5193	Security LFIC Complete	6	1-7/16"	599.544	1765.250	1765.250	1765.250	1765.250
5193	Security LFIC Complete	7	1-5/8"	599.700	1765.344	1765.406		
K300	ASSA ABLOY ACCENTRA™ KeyMark® Standard Fixed Core	6	1-1/8"	599.544	KP4	1765.250		
K300	ASSA ABLOY ACCENTRA™ KeyMark® Standard Fixed Core	7						
K840/ K880	ASSA ABLOY ACCENTRA™ KeyMark® LFIC Complete / Housing Only	6	1-7/16"	599.700	1765.406	1765.500		
K840/ K880	ASSA ABLOY ACCENTRA™ KeyMark® LFIC Complete / Housing Only	7	1-5/8"	NA	1765.563	1765.719		
K640/ K680	ASSA ABLOY ACCENTRA™ KeyMark® SFIC Complete / Housing Only	6	1-1/4"	599.544	KP4	1765.250		
K640/ K680	ASSA ABLOY ACCENTRA™ KeyMark® SFIC Complete / Housing Only	6 or 7	1-3/8"	599.700	1765.187	1765.406		
A640/ K680	Best® Keyway SFIC Complete / Housing Only	6	1-1/4"	599.544	KP4	1765.250		
A640/ K680	Best® Keyway SFIC Complete / Housing Only	6 or 7	1-3/8"	599.700	1765.187	1765.406		
2109	Schlage® "C" Keyway Fixed Core Available 0-bitted or keyed random.	6	1-1/8"	599.419	No Collar	No Collar		

\*Based on 1-3/4" door thickness. Collar length required must be specified for cylinders and/or housings ordered separately.

LFIC = Large Format Interchangeable Core

SFIC = Small Format Interchangeable Core

NA = Application Not Available

## CYLINDERS

### Component

The following chart details component cylinders for use with 540F series trim.

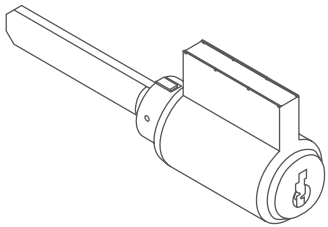
	Model #	Description	Pins
	1802	Standard Lever Fixed Core	6
	1802A	Standard Lever Fixed Core	7
	5802A	Security Lever Fixed Core	7
	1210	LFIC Only	6
	1220	LFIC Only	7
	5210	Security LFIC Only	6
	5220	Security LFIC Only	7
	K402	ASSA ABLOY ACCENTRA™ KeyMark® Lever Fixed Core	6 or 7
	K800	ASSA ABLOY ACCENTRA™ KeyMark® LFIC Only	6 or 7
	K600	ASSA ABLOY ACCENTRA™ KeyMark® SFIC Only	6 or 7
	A600	Best® Keyway SFIC Only	6 or 7
	2802	Schlage® "C" Keyway Fixed Core. Available 0-bitted or keyed random.	6
	3804*	Corbin Russwin "L4", Corbin "60", Russwin "D1", Sargent® "LA" or Schlage® "E" Keyway Fixed Core. Specify keyway. Available keyed random	6

\*Requires the 107S kit. These cylinders are not ANSI/BHMA certified.

## CYLINDERS

### Mortise

The following chart details mortise cylinders for use with 350F, 650F, 660F, 670F trims, cylinder dogging, delayed egress, and 7116 alarms:

				350F/650F		660F/670F		Cylinder Dogging/ DEED/7116	
				Cam	Collar	Cam	Collar	Cam	Collar
Model #	Description	Pins	Length						
2153	Standard Fixed Core	6	1-1/8	2160	NA	2160	NA	2160	No Collar
		6	1-3/4		No Collar		KP4		NA
		7	1-1/4		NA		NA		1765.156
		7	1-3/4		No Collar		KP4		NA
2196	LFIC Complete	6	1-1/2		NA		NA		1765.406
		6	1-3/4		No Collar		KP4		NA
2197	LFIC Complete	7	1-11/16		KP4		1765.250		1765.594
5153	Security Fixed Core	6	1-1/8		NA		NA		No Collar
		7	1-1/4		NA		NA		1765.156
U5153	High Security Fixed Core	6	1-1/8		NA		NA		NA
		7	1-1/4		NA		NA		1765.406
5196	Security LFIC Complete	6	1-1/2		NA		NA		1765.406
		6	1-3/4	No Collar	KP4	NA			
5197	Security LFIC Complete	7	1-11/16	KP4	1765.250	1765.594			
K100	ASSA ABLOY ACCENTRA™ KeyMark® Standard Fixed Core	6 or 7	1-1/8	KC1	NA	KC1	NA	KC1	No Collar
			1-3/4	No Collar	KP4	KC1	NA		
			1-3/4	Riveted	KP4	Riveted	1765.375	NA	NA
K820/K860	ASSA ABLOY ACCENTRA™ KeyMark® LFIC Complete/ Housing Only	6 or 7	1-3/4	KC1	No Collar	KC1	KP4	KC1	1765.406
		7	1-11/16		KP4		1765.375		1765.594
K620/K660	ASSA ABLOY ACCENTRA™ KeyMark® SFIC Complete/ Housing Only	6	1-1/4		NA		NA		1765.156
		6 or 7	1-3/8	No Collar	1765.281				
		6	1-3/4	Riveted	KP4	Riveted	1765.375	NA	NA
A620/K660	Best Keyway SFIC Complete/ Housing Only	6	1-1/4	KC1	NA	KC1	NA	KC1	1765.156
		6 or 7	1-3/8		No Collar		1765.281		
		6	1-3/4	Riveted	KP4	Riveted	1765.375	NA	NA
2553	Schlage® "C" Keyway Fixed Core. Available 0-bitted or keyed random.	6	1-1/8	2160	NA	2160	NA	2160	No Collar

NA = Application Not Available

## CYLINDERS

### Mortise

The following chart details mortise cylinders for use with inside of SDA16 door alarm, KRM200SM, KRM200 standard and windstorm mullions

				SDA16 Inside		KRM200SM/KRM200 (Standard)		KRM200 (Windstorm)  Hurricane				
Model #	Description	Pins	Length	Cam	Collar	Cam	Collar	Cam	Collar			
2153	Standard Fixed Core	6	1-1/8"	2160	No Collar	2160	1765.312	2160	1765.156			
2153	Standard Fixed Core	7	1-1/4"		No Collar		1765.500		1765.250			
2196	LFIC Complete	6	1-1/2"		KP4		1765.750		1765.500			
2197	LFIC Complete	7	1-11/16"		1765.250		1765.844		1765.719			
5153	Security Fixed Core	6	1-1/8"		No Collar		1765.312		1765.156			
5153	Security Fixed Core	7	1-1/4"		No Collar		1765.500		1765.250			
U5153	High Security Fixed Core	6	NA		NA		NA		NA			
U5153	High Security Fixed Core	7	NA		NA		NA		NA			
5196	Security LFIC Complete	6	1-1/2"		KP4		1765.750		1765.500			
5197	Security LFIC Complete	7	1-11/16"		1765.250		1765.844		1765.719			
K100	ASSA ABLOY ACCENTRA™ KeyMark® Standard Fixed Core	6 or 7	1-1/8"		KC1		No Collar		KC1	1765.312	KC1	1765.156
K820/ K860	ASSA ABLOY ACCENTRA™ KeyMark® LFIC Complete / Housing Only	6	1-1/2"				KP4			1765.750		1765.500
K820/ K860	ASSA ABLOY ACCENTRA™ KeyMark® LFIC Complete / Housing Only	7	1-11/16"	1765.250		1765.844	1765.719					
K620/ K660	ASSA ABLOY ACCENTRA™ KeyMark® SFIC Complete / Housing Only	6	1-1/4"	No Collar		1765.500	1765.250					
K620/ K660	ASSA ABLOY ACCENTRA™ KeyMark® SFIC Complete / Housing Only	6 or 7	1-3/8"	No Collar		1765.563	1765.500					
A620/ K660	Best® Keyway SFIC Complete / Housing Only	6	1-1/4"	No Collar		1765.500	1765.250					
A620/ K660	Best® Keyway SFIC Complete / Housing Only	6 or 7	1-3/8"	No Collar		1765.563	1765.500					
2553	Schlage® "C" Keyway Fixed Core. Available 0-bitted or keyed random.	6	1-1/8"	2160		No Collar	2160	1765.312		2160		1765.156

Based on 1-3/4" door thickness. Collar length required must be specified for cylinders and/or housings ordered separately.

LFIC = Large Format Interchangeable Core.

SFIC = Small Format Interchangeable Core.

NA = Application Not Available



## COLLARS & TAILPIECES

### Cylinder Collars

If required, cylinder collar size must be specified.

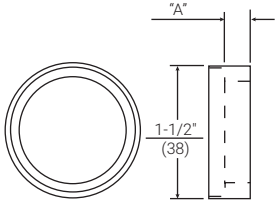
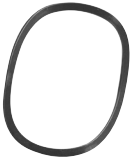
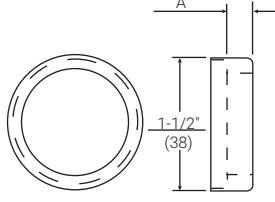
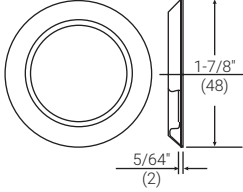
			
<p><b>1765 Recessed Cylinder Collar</b>  <b>"A" Dimension:</b> Thicknesses from 1/16" (2mm) to 1-15/32" (37mm) as required.  <b>Material:</b> Brass, Bronze</p>	<p><b>KP3 Wave Washer</b>            (Furnished standard with 1765 collar for ASSA ABLOY ASSA ABLOY ACCENTRA™ KeyMark® cylinders and 630F series trim).</p>	<p><b>599 Recessed Cylinder Collar with Radius "A" Dimension:</b>            Thicknesses from 1/16" (2mm) to 1-15/32" (37mm) as required.  <b>Material:</b> Brass, Bronze</p>	<p><b>KP4 Flush Mount Cylinder Collar</b>  <b>Material:</b> Brass, Bronze</p>

### Long Tailpiece Kit

Long tailpiece kit for use with escutcheon series trim, up to 4-1/2" thick doors.

Door Thickness	Trim Type	Part Number
2" - 2-1/2"	620F and 630F Series Trim	81-9500-1665-000
2-1/2" - 3-1/2"	620F and 630F Series Trim	81-9500-1635-000
3-1/2" - 4-1/2"	620F and 630F Series Trim	81-9500-1636-000

Specify part number to order.

### Von Duprin® Tailpiece

This tailpiece is available for the ASSA ABLOY ACCENTRA™ 1109 rim cylinder to operate the night latch function for Von Duprin exit devices. To order, specify model number: 1145VD.



**STRIKES**

**Rim Devices**

<p><b>757F</b> Standard strike for 7100(F), 7150(F), 7200M(F) and 7250M(F) devices. Supplied with #10-24 x 3/4" machine screws, two shims (each 1/16" thick), and one locking plate.</p>	<p><b>757FWS</b> Standard strike for 7150(F)WS and 7250M(F)WS devices. Supplied with 2 each #10-24 x 1-1/4" and 2 each #10-24 x 3/4" machine screws, two shims (each 1/16" thick), one locking plate and one interlocking bracket (not shown) with 4 each #10-24 x 3/4" machine screws.</p>	<p><b>759</b> Standard strike for 7200, 7205 devices.</p>	<p><b>793</b> Optional strike for double door applications without a mullion. Supplied with #10-24 x 3/4" machine screws, two shims (each 1/16" thick), and one locking plate. Panic only.</p>

**Vertical Rod Devices - Top Strikes**

<p><b>791</b> Standard top strike for 7110(F), 7120(F), 7210, 7220, 7210M(F), 7220M(F) series devices. Supplied with #10-24 x 3/4" machine screws, two shims (each 1/16" thick), and one locking plate.</p>	<p><b>726</b> Standard top strike for 7170(F) series devices. Supplied with special #10-24 x 3/4" machine screws.</p>	<p><b>761</b> Standard top strike for 7160(F) series devices. Supplied with #10-32 x 3/8" machine screws and #10 x 1" sheet metal screws.</p>	<p><b>797</b> Optional bracket for mounting 791 top strike in flush transom opening. Supplied with 1/4-20 machine screws; SN-134 sex nuts, optional.</p>

**Vertical Rod Devices - Bottom Strikes**

<p><b>790</b> Standard bottom strike for 7110(F), 7120(F), 7160(F), 7170(F), 7210, 7220, 7210M(F), 7220M(F) series devices. Press in place.</p>	<p><b>794</b> Optional bottom strike for fire openings using saddle thresholds or for flush floor mount. Must use for fire openings with 1/2" thresholds. Supplied with #10-24 x 1/2" machine screws and floor anchors.</p>	<p><b>702</b> Optional bottom strike for bottom pullman latch option. Supplied with #8 x 8/32" combination screws.</p>

**STRIKES**

**Mortise Devices**

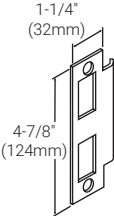
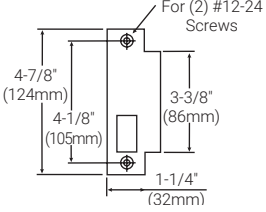
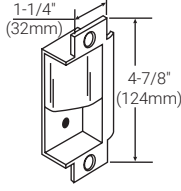
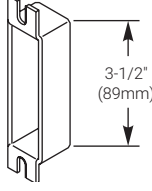
			
<p><b>798</b>  Standard curved lip ANSI strike used with 7130(F) devices. (1-1/4" lip)</p>	<p><b>712</b>  Optional flat lip ANSI strike used with 7130 devices for pairs of doors with astragals. (7/8" lip)</p>	<p><b>718</b>  Optional open back strike. Permits opening of the inactive door for pairs of doors where approved by door manufacturer.</p>	<p><b>202</b>  Optional strike box for ANSI strikes. 7/8" (22mm) deep.</p>

## ACCESSORIES/OPTIONS

### Shim Kits

Shim kits, for devices on doors with interfering molding, are available. Each standard shim kit contains 2 sets of 1/8" thick shims to shim a device 1/8" (3mm) or 1/4" (6mm). Windstorm (WS) shim kits contain 3 sets of 1/8" thick shims. Longer device mounting screws (not included) are required for more than 1/4" (6mm) shimming. 693 (Black) finish.

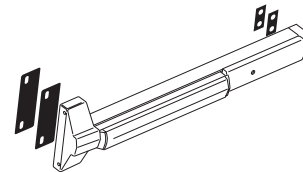

<b>723</b>	Shim kit for 7100(F) series rim, 7150(F) series SquareBolt®, 7120(F), 7160(F) series* concealed vertical rod, and 7130(F) series* mortise exit devices.
<b>723WS</b>	Shim kit for 7150(F)WS series SquareBolt exit devices.
<b>723NS</b>	Shim kit for 7200 series rim, 7200M(F) series rim, 7250 series SquareBolt, 7250M(F) series SquareBolt, 7220 series* and 7220M(F)* concealed vertical rod exit devices.
<b>723NSWS</b>	Shim kit for 7250M(F)WS series SquareBolt exit devices.
<b>724</b>	Shim kit for 7110(F) and 7170(F) series surface vertical rod exit devices.
<b>724WS</b>	Shim kit for 7170(F)WS series surface vertical rod exit devices.
<b>724NS</b>	Shim kit for 7210(F) series surface vertical rod exit devices.

\*Note: Special mortise or concealed vertical rod components needed for openings requiring more than (2) shim kits, or for shimmed mortise devices in doors over 1-3/4" (44mm) thick. Details on application.

### Extension Rods

Model #	Length
7010-2	2" (51mm)
7010-6	6" (152mm)
7010-12	12" (305mm)
7010-24	24" (610mm)

Specify finish.

### Specialty Fasteners

#### Sex Nuts:

Required for wood, composite or unreinforced metal doors.

- **SN-104** – Interlock bracket pack of (4) 10-24 sex nuts for all fire rim and SquareBolt® devices.
- **SN-134** – pack of (4) 1/4-20 sex nuts for all devices.

#### TORX® Security Screws:

Available for factory product orders. Wood screws may only be used in predrilled pilot holes of solid core wood doors.

## ACCESSORIES/OPTIONS

### 720 Dummy Pushbar

For push-pull vestibule doors leading to doors with 7000 series exit devices. Bars fit doors up to 48" (122cm) wide. Same finishes as devices. Specify 720 x finish.

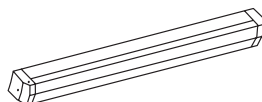

### Cylinder Dogging

Cylinder dogging is available for all panic-listed exit devices only. Requires use of 1-1/8" mortise cylinder. When ordered with a device, cylinder must be ordered separately. (See How to Order, "Fourth Digit", page 5.) Cylinder dogging kit available; specify 715-48 (cylinder not included with this kit).

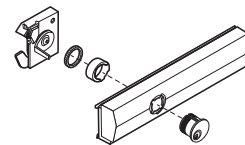

### 730 Touchpad Cover

Field replacement cover to renew touchpad looks. Specify 730-36 or 730-48 x finish.

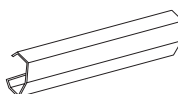

### Lumi-Lite Touchpad Cover

The Lumi-lite touchpad cover can be ordered separately and easily retrofits to existing 7000 exit devices in the field. To order specify: 730-36LUM for 36" cover and 730-48LUM for 48" cover

### Replacement End Cap

The 7000 series replacement end cap is designed with heavy-duty material with three screw holes in strategic locations to resist abuse and maintain functionality. The ECK7 kit is available for easy retrofit to existing exit devices. To order retrofit kit, specify ECK7 x finish.



### Reinforced End Cap\*\*

This end cap consists of a solid steel plate welded to the end bracket which evenly distributes impact forces over a larger surface area, thus eliminating point loading. To order with device, specify option ECK3. To order separately, specify kit model number ECK3. Kit includes reinforced bracket, end cap and (6) 1/4" x 20 screws.

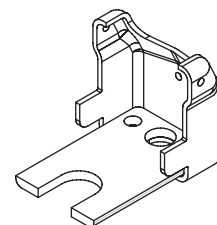

### Flush End Cap

The flush end cap is a heavy-duty flush mounted end cap constructed of solid cast or stainless steel materials. For use on exit devices subject to abuse by vehicles being pushed through the doorway opening; i.e. carts, gurneys, wagons, etc. To order with device, specify option: ECK1. Available as a retrofit kit for existing installations, to order specify part number: 81-9500-0620 x finish.



### Bottom Pullman Latch

Optional bottom pullman latch available for panic listed vertical rod exit devices. To order with devices, specify "BPL." 702 bottom strike required, see page 54.



\*\*Note: Six 1/4 x 20 screws come standard with either ECK3 option or kit. Only two screws required to fasten end cap assembly to door for retrofit. Other four screws are used with SquareBolt® Latch Head if ordered as an ECK3 option with complete device. When the kit is ordered a new end cap is also supplied, finish must be specified.

## ACCESSORIES/OPTIONS

### Anti-Pry Bracket

The anti-pry bracket offers end users increased security by improving resistance against jamb spreading during a pry attack. When the door is in the closed position, the anti-pry bracket interlocks in position between the exit device strike and frame preventing the strike and exit device latch from being separated. For use with all 7100(F) rim and 7150(F) SquareBolt® devices. Kit includes interlock bracket and end cap shim, the standard exit device mounting screws can be used, therefore, no additional fasteners are required. Black powder coat finish. To order specify option/model number: 725



### Less Bottom Rod

7170(F90) surface and 7160(F90) concealed vertical rod exit devices available less bottom rod. Fire-rated devices supplied standard with a heat-activated door bolt popper. To order, suffix LBR.

### Plastic Installation Template

Provided as a standard with all 7000 series exit device, the plastic installation template facilitates door markings over traditional paper templates. This provides a more accurate door prep which reduces installation mistakes and overall installation time. Template dimensions: 8-1/4" x 3-1/4" (210mm x 83mm). To order separately, specify part number: 60-7000-9100-999.



### Schlage® Cam Assembly

This cam and housing assembly includes a cam engineered to accept Schlage rim cylinders. No modifications are required to existing 500 and 600 series exit device trims thus maintaining the trim's classroom and storeroom functions. To order, specify part number: 60-7000-0815.



### Surface Bolt Kit

Designed for severe windload (Hurricane Code) environments where surface bolts are required (e.g., on inactive doors). To order separately, for Standard 12" bolt length specify Part No 988CR. Optional sizes available. Specify 988-1 (18") or 988-2 (24") bolt lengths.

## MULLIONS

### M200(F) Removable Mullion

M200(F) steel mullions are for use with 7100(F) series exit devices. Mullions may be field cut to fit opening. Gray paint finish.

- M200 panic rated.  
Tubular steel, 2" x 3" (51mm x 76mm). Specify 7'2".
- M200F 3 hour fire rated.  
Tubular steel, 2" x 3" (51mm x 76mm). Specify 7'2" or 10'<sup>1</sup> (Fire rated up to 8').
- M200FWS 3 hour fire rated.  
Certified hurricane resistant (refer to local codes).  
Tubular steel, 2" x 3" (51mm x 76mm). Specify 7'2" or 8'.  Hurricane

**Notes:**

1. For 8' length Mullion must be order as M200F option and cut in the field to 8' size.

### M300 Removable Mullion

M300 mullions are for use with 7200 series exit devices. They consist of an aluminum extrusion 1-1/4" x 3" (32mm x 76mm), with built-in strikes for device bolts. Supplied with mounting brackets, mechanical fasteners, and mullion stabilizers. Available finishes are 628 (Satin, clear anodized) and 695 (dark amber coat). Specify 8' or 10'. For 9' mullion, specify 10' and cut to size in field.

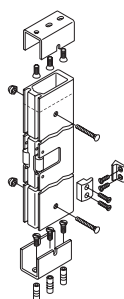

**M300**

### 102S Mullion Stabilizer Kit

Recommended for high openings and whenever door movement must be further restricted. Supplied standard with M300 mullions. To order separately, specify 102S.

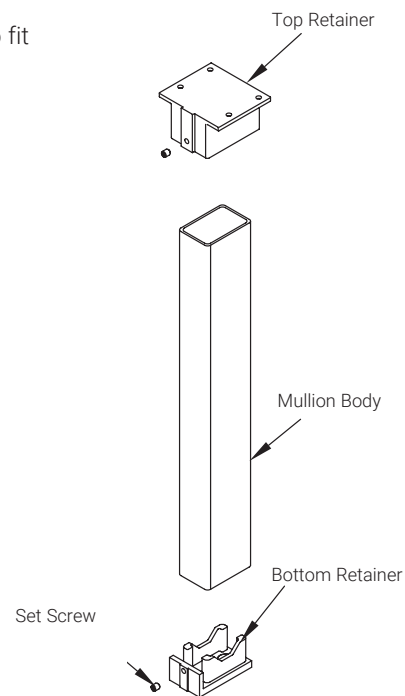

**M200(F)**

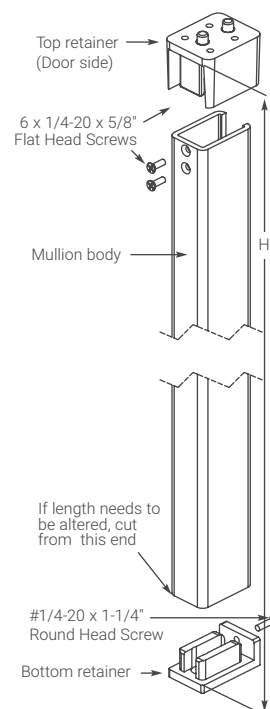

**M200FWS**

## MULLIONS

### KRM200(F) Keyed Removable Mullion (KRM)

Keyed removable mullions are for use with 7100(F) series exit devices. They are designed for simple removing when an unobstructed large opening is required and easy replacement and locking to maintain the integrity of the opening.

- Easy cylinder installation.
- Mullion automatically relocks when reinstalled without the use of the cylinder key.
- When ordering, add KR prefix to mullion, example: KRM200 and KRM200F.
- KRM200 panic rated. Specify 7'2".
- KRM200F 1-1/2 hour fire rated. Specify 7'2" or 10'<sup>1</sup> (Fire rated up to 8')
- KRM200FWS 3 hour fire rated.  
Certified hurricane resistant (refer to local codes). Specify 7'2" or 8'.  Hurricane

**Notes:**

**1. For 8' length Mullion must be order as KRM200F option and cut in the field to 8' size.**

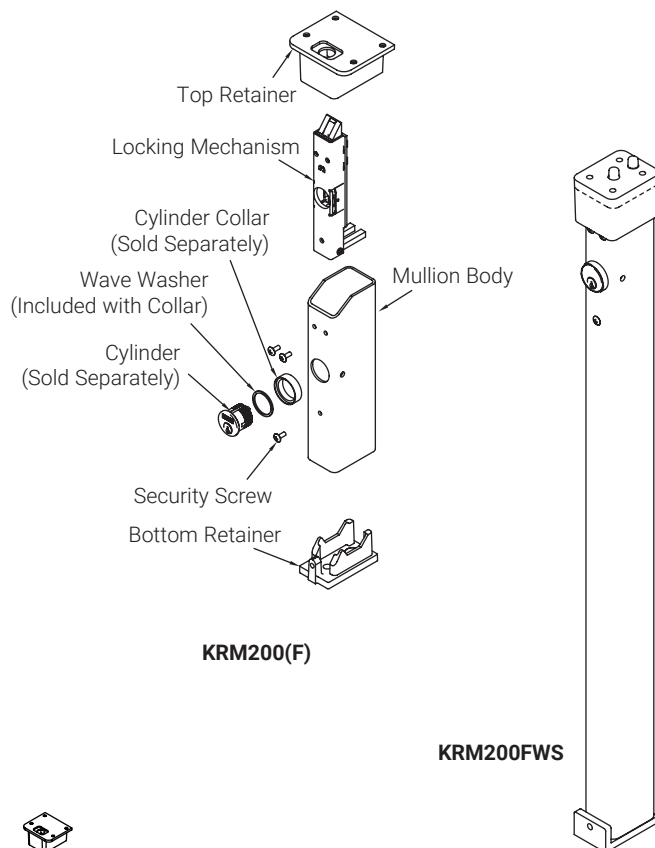

### Split Mullion

Hassle-free transportation with a 30% smaller packaging size. Mullions may be field cut to fit opening. Gray painted finish. Available only in 8'. When ordering add suffix SM, example M200SM and KRM200SM

**M200SM Standard**

- Panic rated. Specify 8'
- Tubular steel, 2" x 3" (51mm x 76mm).

**KRM200SM Key Removable Split Mullion**

- Easy cylinder installation.
- Panic rated. Specify 8'
- Tubular steel, 2" x 3" (51mm x 76mm).

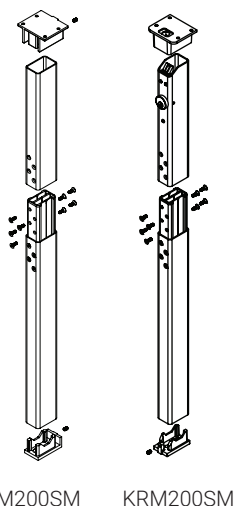



## MULLION CYLINDER KIT AND OPTIONS

### M200(F), SM and KRM Options

- **M203 Spacer Block**

Recommended for double rabbeted frames where the stop face width is less than the mounting hole spacing or for applications with 5-3/4" (146mm) or less door frames.

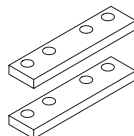

- **M204 Angle Bracket**

Recommended for any header configuration with less than 3" (76mm) of mounting surface.

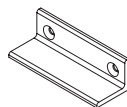

Mullion Cylinder Kit	Available with the following mullions series
AMCK1	KRM200
	KRM200F
	KRM200SM
AMCK2	KRM200FWS

Note: Mullion cylinder kit contains washer, collar and cylinder

\*Specify finishes and cylinder keyed code when ordering

EX: AMCK1 X FINISH X CYLINDER KEYED CODE  
(i.e. AMCK1 X 630 X CT6)

Keyed Codes	Description
CT6	LFIC Complete, 6 Pin
CT6LL	ASSA ABLOY ACCENTRA™ KeyMark® LFIC w/Temp LFIC, 6 Pin
CT6SD	ASSA ABLOY ACCENTRA™ KeyMark® SFIC w/Temp Disposable SFIC, 6 Pin
CT6SL	ASSA ABLOY ACCENTRA™ KeyMark® SFIC w/Temp Lockable SFIC, 6 Pin
CT7	LFIC Complete, 7 Pin
CT7LL	ASSA ABLOY ACCENTRA™ KeyMark® LFIC w/Temp LFIC, 7 Pin
CT7SD	ASSA ABLOY ACCENTRA™ KeyMark® SFIC w/Temp Disposable SFIC, 7 Pin
CT7SL	ASSA ABLOY ACCENTRA™ KeyMark® SFIC w/Temp Lockable SFIC, 7 Pin
CY	Standard Fixed Core
ICLC	LFIC, Less Core
KM	ASSA ABLOY ACCENTRA™ KeyMark® Standard Fixed Core
KMLIC	ASSA ABLOY ACCENTRA™ KeyMark® LFIC Complete
KMLICH	ASSA ABLOY ACCENTRA™ KeyMark® LFIC Housing Only
KMSIC	ASSA ABLOY ACCENTRA™ KeyMark® SFIC Complete
KMSICH	ASSA ABLOY ACCENTRA™ KeyMark® SFIC Housing Only
S	Security Fixed Core
SC	Schlage® "C" Keyway Fixed Core
SFIC	Best® Keyways SFIC Complete
SFICLC	Best® Keyway SFIC Housing Only
SIC	Security LFIC Complete

**DIMENSIONS**

**Device**

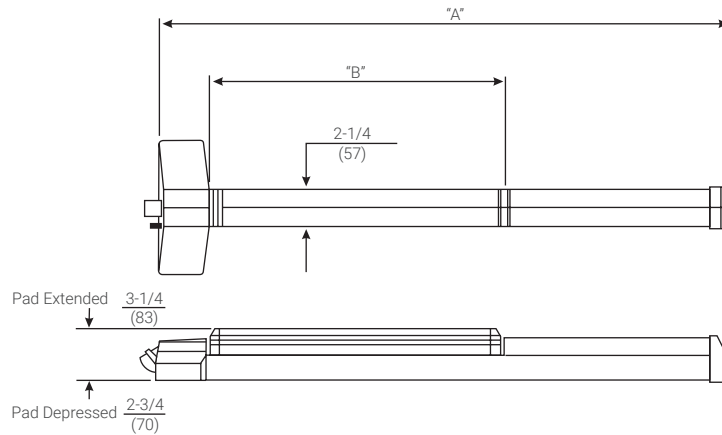
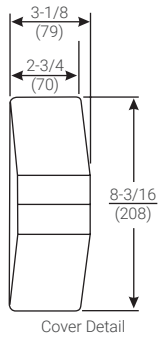

7100 Series  
(all variables)

Series	"A"	"B"
7100-36	32-7/8" (835mm)	18" (457mm)
7100F-36		
7100-48	44-7/8" (1130mm)	24" (610mm)
7100F-48		

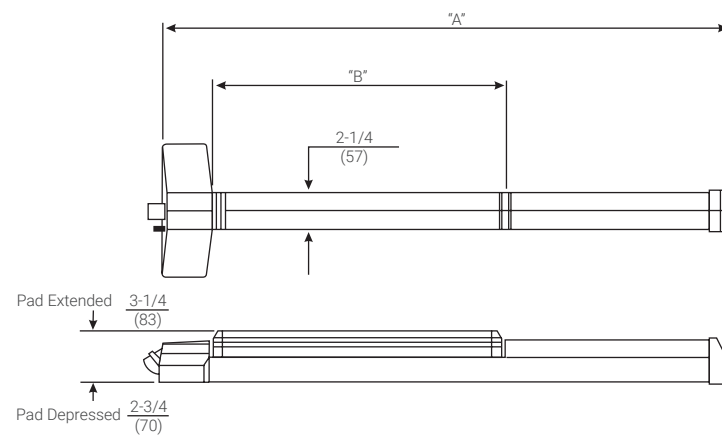
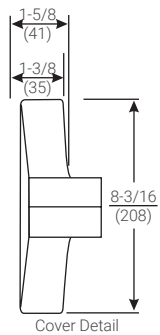

7200 and 7200M Series  
(all variables)

Series	"A"	"B"
7200-36	34-5/8" (880mm)	18" (457mm)
7200M-36 7200MF-36	32-7/8" (835mm)	18" (457mm)
7200-48	46-5/8" (1184mm)	24" (610mm)
7200M-48 7200MF-48	44-7/8" (1130mm)	24" (610mm)

**DIMENSIONS**

**Trim Dimensions**

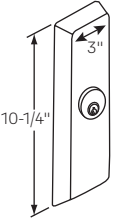
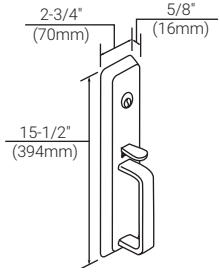
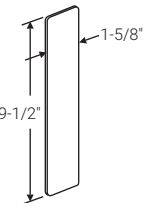
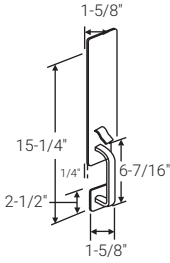
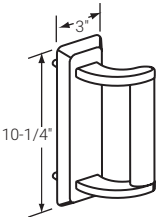
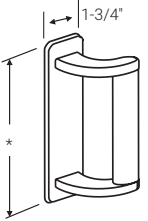
620F/650F Series	630F/660F Series	500F Series
 <p>Projection: 13/16" (20mm)</p>	 <p>Projection: 2-3/4" (70mm)</p>	 <p>Projection: 1/4" (6mm)</p>
510F Series	680F Series	480F Series
 <p>Projection: 2-1/8" (54mm)</p>	 <p>Projection: 3" (76mm)</p>	 <p>Projection: 2-7/8" (73mm)</p>

\*Length varies by pull, see page 30

## SAMPLE SPECIFICATIONS

### Specification

Exit devices shall be 7000 Series Pushpad Exit Devices as manufactured by ASSA ABLOY ACCENTRA™.

The exit device chassis shall be cold forged steel, electroplated for corrosion resistance, and shall be architecturally finished brass, bronze or stainless steel. The pushpad mechanism shall be constructed of extruded aluminum and shall be scalped with architecturally finished brass, bronze or stainless steel. The maximum projection shall be 3-1/4" when the pushpad is active and 2-3/4" when the pushpad is dogged down. Nylon bearings and stainless steel springs shall be used for long life and durability; only torsion springs are acceptable. Rear and active case covers shall be wrought brass or bronze and shall be plated to match the exit bar. Plastic or painted covers are not acceptable. Latchbolts shall be steel and shall incorporate a deadlocking latch for increased security. Devices without deadlocking latches are not acceptable. Mounting screws shall be concealed to deter tampering. Devices shall be closed on all sides with no pinch points. Exit devices shall be easily field sized to accommodate various door widths.

Panic-listed exit devices shall have single point, one quarter turn hex key dogging standard. Optional cylinder dogging shall be available on panic listed devices. Devices with hex key dogging shall be easily field converted to cylinder dogging. Panic listed devices shall be available less dogging.

Trims shall be throughbolted with concealed fasteners. Escutcheon and pull-type trims shall be constructed of brass or bronze. All lever trims shall use cast or forged levers. On rim, SquareBolt® and vertical rod trims with cylinders, the mechanism that locks and unlocks the trim shall be housed in the trim and not in the active case of the exit device. Lever trims (except mortise) shall be Free-Wheeling with clutch mechanism allowing lever to rotate 60° when locked for ideal protection. Lever trims shall match those on ASSA ABLOY ACCENTRA™ mortise and cylindrical locksets.

Exit devices and trims shall be furnished in ANSI/BHMA standard architectural finishes.

Exit devices shall be listed by Underwriters Laboratories (UL) for safety as panic hardware. Fire-rated devices shall be listed for A label and lesser class doors.

Certification:  
ANSI/BHMA A156.3, Grade 1

Devices, trims and cylinders shall be from one manufacturer.

Devices and 600 Series trim shall carry a five-year limited warranty.

500 Series trim shall carry a one-year limited warranty.

Electronic components shall carry a two-year limited warranty.

### Delayed Egress Specification

Delayed egress exit devices shall be 7100/7200 Series (rim, SquareBolt®, mortise or concealed vertical rod) with the "D" suffix, manufactured by ASSA ABLOY ACCENTRA™.

The delayed egress device secures the door in the locked mode. Depressing the pushpad for less than three seconds will sound the device siren without initiating the alarm. Depressing the pushpad longer than three seconds will initiate an irreversible local audible beeping tone and allow the device to release for egress after 15 seconds. The alarm will continue until reset by the mechanical key switch located on the device. (When acceptable by local code agency, the delay period may be increased to 30 seconds, or other approved amount of time. Consult factory.)

Devices shall be 24 volts DC.

The exit device chassis shall be cold forged steel, electroplated for corrosion resistance, and shall be architecturally finished brass, bronze or stainless steel. The pushpad mechanism shall be constructed of extruded aluminum and shall be scalped with architecturally finished brass, bronze or stainless steel. The maximum projection shall be 3-1/4" when the pushpad is active and 2-3/4" when the pushpad is depressed. Nylon bearings and steel springs shall be used for long life and durability. Active case and alarm end cover shall be wrought brass, bronze or stainless steel and shall be plated to match the exit bar. Painted or plastic covers or end caps are not acceptable. Latchbolts shall be steel and shall incorporate a deadlocking latch for increased security. Devices without deadlocking latches are not acceptable. Mounting screws shall be concealed to deter tampering. Devices shall be closed on all sides with no pinch points. Device active cover and end cap attaching screws shall be security TORX®. When required, door position switches used on rim or SquareBolt devices shall be incorporated into the latch assembly of the device to allow added security.

Trims shall be thrubolted with concealed fasteners. Escutcheon and pull-type trims shall be constructed of brass, bronze or stainless steel. All lever trims shall use cast or forged levers. On rim, SquareBolt and vertical rod trims with cylinders, the mechanism that locks and unlocks the trim shall be housed in the trim and not in the active head of the exit device. Lever trims shall match those on ASSA ABLOY ACCENTRA™ mortise and cylindrical locksets. Lever trims (except mortise) must have a clutch or Free-Wheeling spring assembly when in the locked mode for ideal protection and reduced damage to the trim. Rigid lever trims are not acceptable.

Exit devices, trims and cylinders must be from one manufacturer.



The ASSA ABLOY Group is the global leader in access solutions.  
Every day, we help billions of people experience a more open world.

ASSA ABLOY Opening Solutions leads the development within door openings and products for access solutions in homes, businesses and institutions. Our offering includes doors, frames, door and window hardware, mechanical and smart locks, access control and service.

**ACCENTRA**  
**ASSA ABLOY**

**TECHNICAL SUPPORT**

(troubleshooting, product use and application, returns)

Tel: 855-557-5078

Email: [techsupport.accentra@assaabloy.com](mailto:techsupport.accentra@assaabloy.com)

**CUSTOMER SUPPORT**

(orders, product configuration, pricing, lead-time)

Tel: 855-557-5078 x2

Email: [Customerservice.Accentra@assaabloy.com](mailto:Customerservice.Accentra@assaabloy.com)

**U.S.A.:**

**ASSA ABLOY ACCENTRA™**

225 Episcopal Road  
Berlin, CT 06037-4004

Tel: 1-800-438-1951

Fax: 1-800-338-0965

[www.accentra-assaabloy.com](http://www.accentra-assaabloy.com)

**Canada:**

**ASSA ABLOY Door Security Solutions Canada**

160 Four Valley Drive  
Vaughan, Ontario L4K 4T9

Tel: 1-800-461-3007

Fax: 1-800-461-8989

[assaabloydss.ca](http://assaabloydss.ca)

**International:**

**ASSA ABLOY Americas International**

Tel: 1-905-821-7775

Fax: 1-905-821-1429

[assaabloyai.com](http://assaabloyai.com)