

DOOR BOTTOM

Automatic, Non-Handed, Reversible

About Door Bottom Seals:

Pemko Door Bottom Seals consist of a variety of solutions for sealing a door to the threshold or floor surface.

About Automatic Door Bottoms:

Pemko Automatic Door Bottoms consist of an aluminum case which surrounds a movable drop bar seal. The drop bar seal is actuated by a plunger which contacts the jamb as the door is closing, forcing the drop bar seal down against the floor or threshold. Automatic Door bottoms are frequently used when an automatic door bottom is required to close over carpet.

- Low closing force.
- Provide excellent seals to keep out draft, dust, moisture, insects, fumes, light and sound.
- End plates provided for all mounting applications.

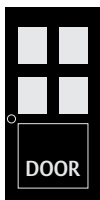
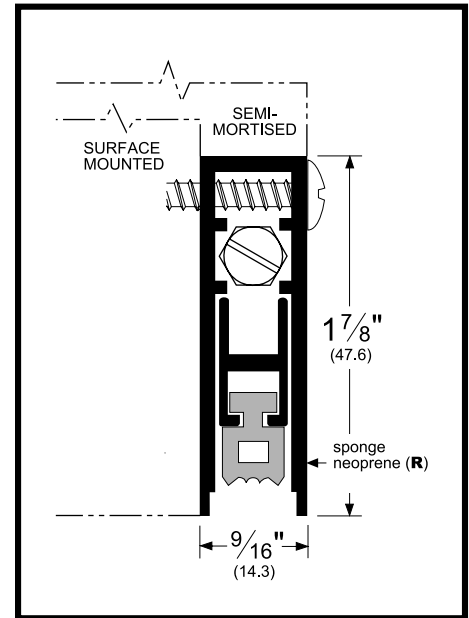

↑
Seals
Bottom
of Door

Product / Available Finishes:

- 4131BDGRL** Bright Dip Gold Anodized Aluminum with Black Sponge Neoprene insert
- 4131CRL** Clear Anodized Aluminum with Black Sponge Neoprene insert
- 4131DRL** Dark Bronze Anodized Aluminum with Black Sponge Neoprene insert
- 4131SNRL** Satin Nickel Anodized Aluminum with Black Sponge Neoprene insert

Testing/Ratings:



Tools Required:

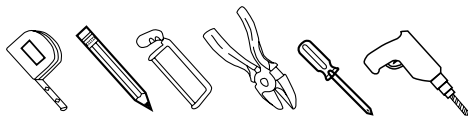

Parts Included in End Cap Kit:

NUMBER	DESCRIPTION	QUANTITY
1	Screw	1
2	End Cap	1
3	Plunger End Cap	1

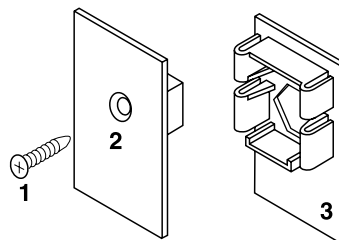

Installation Instructions:

1. If the ADB is to be installed in a semi-mortise, prepare door according to the dimensions shown in the profile drawing on front of label.
NOTE: If a door is fire labeled or of acoustical construction, semi-mortise preparation must be done by the door manufacturer or licensed machiner only.
2. Cut from end opposite actuating plunger only.
3. DO NOT cut off more than two (2) inches.
4. When cutting, be sure that the drop bar is flush with the case on the plunger side and that the gasketing insert projects at least 1/8".
 - For semi-mortise installation, cut ADB to door width.
 - For surface mounted installation, cut ADB 1/8" less than the distance between the stops.
5. Adjust and trim the gasketing insert so that it projects at least 1/16" at each end of the drop bar and case.
6. For nylon brush seal ADB's, use bolt cutters or diagonal cutting pliers that will pinch the strip to retain the bristles (as shown in Figure 1).

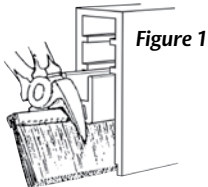

7. Crimp the ends of the brush strip and drop bar to prevent the nylon brush from sliding (as shown in Figure 2).

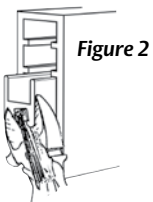

8. With the actuating plunger at the hinge side, fasten the ADB to the door bottom with the screws provided, these Type AB screws will accommodate hollow metal and wood doors.
9. For surface mounted installation, the plunger contacts the stop (as shown in Figure 3).

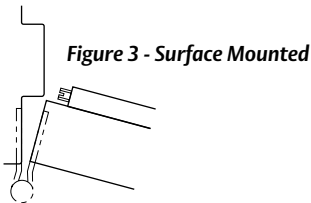

10. For semi-mortise mounted installation, the plunger contacts the rabbet (as shown in Figure 4).

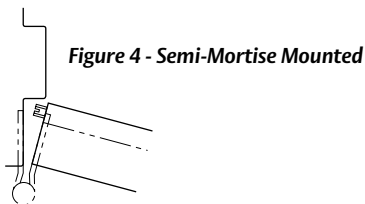

11. The underside edge of the ADB case should be installed flush with the bottom of the door.
12. For wood jambs, a #10 x 1/2" flat head screw is furnished for installation at the point where the plunger contacts the jamb to prevent indenting.
13. Screw the actuating plunger in or out as required until the gasketing insert just touches the sealing surface when the door is closed.
14. It is only necessary to lightly compress the insert against the sealing surface to provide a good seal.
15. Further adjustments may be required for uneven surfaces.

End Plate Installation Instructions:

PLEASE READ THESE INSTRUCTIONS THOROUGHLY BEFORE ATTEMPTING TO INSTALL END PLATES.

IMPORTANT! These parts are made from glass filled nylon. They are very strong, but brittle. Do not attempt to twist or bend them or they will break. This is not a problem if properly installed or removed.

1. The automatic door bottom must be correctly installed and adjusted in accordance with the installation instructions furnished with this product (see other side).
2. Be sure that the drop bar (part that contains the seal) does not project beyond the end of the case when the actuation plunger is depressed (as shown in Figure 7). If it does project beyond the case, it was improperly trimmed in the field. This condition can be corrected by removing the uni and trimming the excess.



Figure 7 - Improper Drop Bar

This shows an improper drop bar protruding from the end of the case. The drop bar should be flush at both ends.



Figure 5 - Plunger End Plate



Figure 6 - End Plate

NOTE: Under no condition should the insert project beyond the edge of the case.

3. Insert the No. 10 x 1/2" flat head screw into the central opening of the endplate and tighten with a small Phillips screwdriver. Insert the end plate into the case at the lock edge side of the door. Power drivers are not suggested as they may over-tighten the screw and possibly break the end plate (as shown in Figure 8).



Figure 8 - Properly Installed End Plate

This shows a properly installed end plate. Do not use power tool to tighten this screw.

4. Next insert the plunger end plate with the hexagon hole. This pushes straight in. It also serves to prevent the plunger from rotating and changing adjustment (as shown in Figure 9 and Figure 10). If this end plate needs to be removed for readjustment, it can be removed in two ways: (1) push the drop bar towards the hinge side of the door and it will eject the end plate; (2) prying at the top of the end plate with a knife or other tool. Do not pry at the bottom. This will cause it to break.

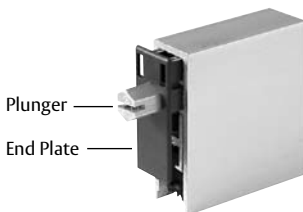

Figure 9

Plunger end plate prevents the plunger adjustment from rotating.

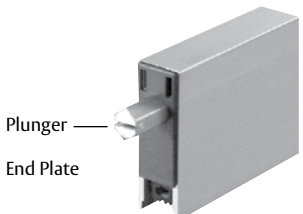

Figure 10

Plunger end plate installed.



ASSA ABLOY

UNITED STATES:

VENTURA, CA
Ph: 800.283.9988
Fax: 800.283.4050

MEMPHIS, TN
Ph: 800.824.3018
Fax: 800.243.3656

CANADA:

VANCOUVER, BC
Ph: 877.535.7888
Fax: 877.535.7444

TORONTO, ON
Ph: 866.243.9816
Fax: 866.243.9817

www.pemko.com

© 2007 Pemko Manufacturing Co.
4131_RL_WEBINS
Rev 1 - 07.01.07