

# ED4000

## Narrow Stile Pushpad Exit Devices



# Introduction

## ED4000

### Table of Contents

Applications.....	2
Applications and Listings.....	3
Functions.....	4
SecureBolt® Features.....	6
Rim Features.....	8
Surface Vertical Rod Features....	10
Concealed Vertical Rod Features.....	12
Trims and Functions.....	14
Electrified Exit Devices.....	18
Mullions.....	29
Options and Accessories.....	30
Cylinders.....	32
How to Order.....	33
Quick Codes.....	34
Facts and Figures.....	36
Helpful Terms.....	37
How to Specify.....	38

### Applications

Designed for applications on narrow stile full glass, aluminum and metal doors in high-use and high-abuse situations, ED4000 Series devices can be teamed with a variety of Corbin Russwin trims to provide desired functions, styles and finishes in new construction and renovations, including:





- Schools and universities
- Health care facilities
- Government and municipal buildings
- Factories and warehouses
- Office and retail complexes
- Transportation facilities
- Hotels and conference centers
- Religious facilities
- Theaters and auditoriums

### Advantages

- Meets ANSI Grade 1 requirements
- Easy-to-use pushpad for quick egress and ADA compliance
- Low projection for barrier-free code compliance
- Heavy-duty construction
- Quiet operation
- Closed on all sides – no projecting parts to inhibit egress
- Devices accommodate various function trims for flexibility
- Through-bolted trims for strength, security, durability, smooth operation and easy installation
- Wide range of designs and finishes to match other Corbin Russwin products
- One-point dogging
- Devices satisfy UL/cUL safety requirements

# Applications and Listings

## ED4000

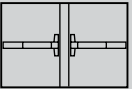
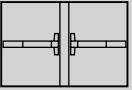
Single Door	UL Listing	Maximum Opening (W x H)	Application	
<b>Rim</b>				
ED4200	Panic	4' x *	Surface applied; single-point latching.	
ED4200M	Panic	4' x *	Surface applied single-point latching.	
ED4200MA	3Hr.	4' x 8'	Surface applied single-point latching.	
<b>SecureBolt®</b>				
ED4200S	Panic	4' x *	Surface applied; single-point latching.	
ED4200SM	Panic	4' x *	Surface applied single-point latching.	
ED4200SMA	3Hr.	4' x 8'	Surface applied single-point latching.	
<b>Surface Vertical Rod</b>				
ED4400	Panic	4' x 10'	Surface applied; two-point latching.	
ED4400M	Panic	4' x 10'	Surface applied two-point latching.	
ED4400MA	3Hr.	4' x 10'	Surface applied two-point latching.	
<b>Concealed Vertical Rod</b>				
ED4800	Panic	4' x 10'	Rods concealed in door; two-point latching.	
ED4800M	Panic	4' x 10'	Rods concealed in door two-point latching.	
ED4800MA	3Hr.	4' x 10'	Rods concealed in door two-point latching.	
Pair of Doors with Removable Mullion	UL Listing	Maximum Opening (W x H)	Application	
<b>Rim x Rim</b>				
ED4200 x ED4200 x 808	Panic	8' x 8'	Two independent active doors with removable mullion.	
ED4200M x ED4200M x 808	Panic	8' x 8'	Two independent active doors with removable mullion.	
ED4200MA x ED4200MA x 808	3Hr.	8' x 8'	Two independent active doors with removable mullion.	
<b>SecureBolt® x SecureBolt®</b>				
ED4200S x ED4200S x 808	Panic	8' x 8'	Two independent active doors with removable mullion.	
ED4200SM x ED4200SM x 808	Panic	8' x 8'	Two independent active doors with removable mullion.	
ED4200SMA x ED4200SMA x 808	3Hr.	8' x 8'	Two independent active doors with removable mullion.	

Note: All ED4000 Series Narrow Stile Pushpad Exit Devices are UL305 panic listed.  
\*UL does not set a door height limitation on panic applications.

# Applications and Listings



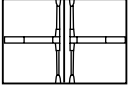
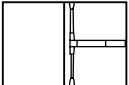
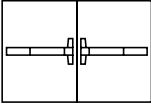
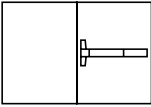







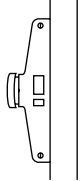
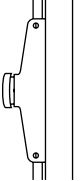
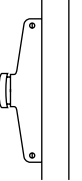
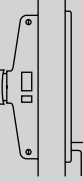

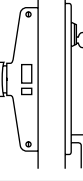

## ED4000

Pair of Doors	UL Listing	Maximum Opening (W x H)	Application	
Surface Vertical Rod				
ED4400 x ED4400	Panic	8' x 10'	Two independent doors with two-point latching, swinging in the same direction.	
ED4400M x ED4400M	Panic	8' x 10'	Two independent doors with two-point latching, swinging in the same direction.	
ED4400MA x ED4400MA	3Hr.	8' x 10'	Two independent doors with two-point latching, swinging in the same direction.	
Surface Vertical Rod (Double Egress)				
ED4400 x ED4400	Panic	8' x 10'	Two independent doors with two-point latching, swinging in opposite directions.	
ED4400M x ED4400M	Panic	8' x 10'	Two independent doors with two-point latching, swinging in the same direction.	
ED4400MA x ED4400MA	3Hr.	8' x 10'	Two independent doors with two-point latching, swinging in the same direction.	
Concealed Vertical Rod				
ED4800 x ED4800	Panic	8' x 10'	Two independent doors with two-point latching, swinging in the same direction.	
ED4800M x ED4800M	Panic	8' x 10'	Two independent doors with two-point latching, swinging in the same direction.	
ED4800MA x ED4800MA	3Hr.	8' x 10'	Two independent doors with two-point latching, swinging in the same direction.	
Concealed Vertical Rod (Double Egress)				
ED4800 x ED4800	Panic	8' x 10'	Two independent doors with two-point latching, swinging in the opposite direction.	
ED4800M x ED4800M	Panic	8' x 10'	Two independent doors with two-point latching, swinging in the same direction.	
ED4800MA x ED4800MA	3Hr.	8' x 10'	Two independent doors with two-point latching, swinging in the same direction.	

Note: All ED4000 Series Narrow Stile Pushpad Exit Devices are UL305 panic listed.

\*UL does not set a door height limitation on panic applications.

### Exit Only, Pull and Thumbpiece Trims

Rim/SecureBolt® ED4200 ED4200S Inside Outside	Surface Vertical Rod ED4400 Inside Outside	Concealed Vertical Rod ED4800 Inside Outside	Type	ANSI No.	Function Description
			Exit Only	01	Exit only; no trim.
			Dummy	02	Entrance by trim when actuating bar is locked down.
			Nightlatch	03	Entrance by trim when latchbolt is retracted by key. Key removable only when locked.
			Classroom*	05	Entrance by thumbpiece. Key locks or unlocks thumbpiece.
			Passage	15	Entrance by trim when latch is released by thumbpiece. Thumbpiece is always active, no cylinder.
			Storeroom (Thumbpiece Active)	06	Entrance by thumbpiece only when released by key. Key removable only when locked.

\*Classroom function trims can be converted to Storeroom function by a simple field adjustment.

# Functions

## ED4000

### Knob, Lever and Thumbturn Trims

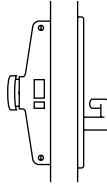
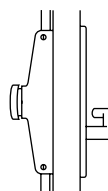
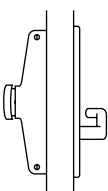
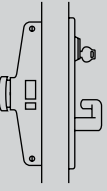
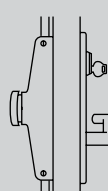
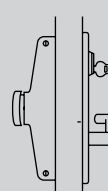
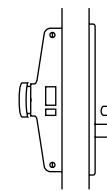
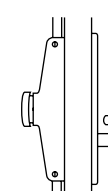
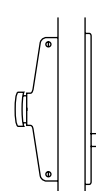
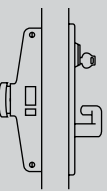
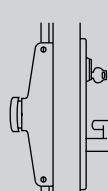
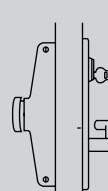
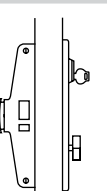
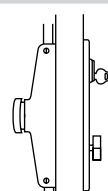
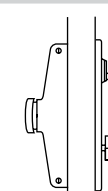
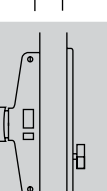
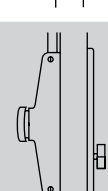
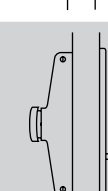
Rim/SecureBolt® ED4200 ED4200S Inside Outside	Surface Vertical Rod ED4400 Inside Outside	Concealed Vertical Rod ED4800 Inside Outside	Type	ANSI No.	Function Description
			Dummy	02	Entrance by trim when actuating bar is locked down.
			Classroom*	06	Entrance by knob or lever. Key locks or unlocks knob or lever.
			Passage	14	Entrance by trim when latchbolt is released by knob or lever. Knob or lever always active, no cylinder.
			Storeroom (Grip Active)	09	Entrance by knob or lever only when released by key. Key removable only when locked.
			Classroom*	11	Entrance by control turn piece. Key locks or unlocks control.
			Passage	16	Latchbolt retracted by thumbturn.

\*Classroom function trims can be converted to Storeroom function by a simple field adjustment.

# SecureBolt® Features

ED4000

## ED4200S Narrow Stile SecureBolt® Exit Device



### Features

#### Handing

Device non-handed.  
Trim handed.

#### Bar Length

Easily field cut to size.  
Standard: 36" (914mm) bar fits 30" - 36" (762mm-914mm) door.  
Optional: 24" (610mm) bar fits 24" (610mm) door; specify W024.  
Optional: 48" (1219mm) bar fits 36" - 48" (914mm-1219mm) door; specify W048.

#### Door Thickness

1-3/4" (44mm) standard.  
Optional: 2" (51mm); specify D200.  
Optional: 2-1/4" (57mm); specify D214.

#### Stile

Minimum width 2" (51mm).

#### Deadbolt

Full 3/4" (19mm) projection, 1" (25mm) wide, positive deadlocking by auxiliary bolt.

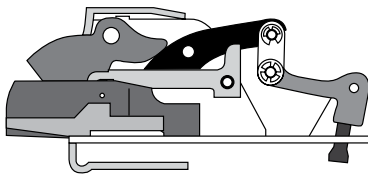

Cutaway Side View

#### Materials

High-grade, heat-treated, corrosion-resistant nickel steel alloy. Finished parts are brass, bronze or stainless steel; stainless steel springs; nylon bearings.

#### Latchbolt

Stainless steel. Slide action deadbolt with positive deadlocking by auxiliary bolt. Two-piece deadbolt mechanism utilizing a roll-back lever which eliminates any contact (friction) with the strike during relocking.

#### Projection

3-1/4" (83mm) active, 2-3/4" (70mm) dogged.

#### Dogging

Standard: single-point 1/4 turn hex key dogging.  
Optional: less dogging; specify M51.  
Optional: cylinder dogging; specify M52.  
Optional: electric dogging, specify M97.

#### Fasteners

Standard: machine screws.  
Optional: sex nuts and bolts; specify M54.

#### Strike

Surface mounted 3/8" (10mm) diameter roller strike, complete with positive locking plate and shims, ensuring low-friction relocking for a long, trouble-free life.

#### Functions and Trims

Through-bolted lever, knob, pull, thumbturn and thumbpiece trims available with wide range of functions; see Trims and Functions, page 14.

#### Cylinders

Cylinder not included unless specified. See Quick Codes, page 32.

#### Removable Mullion

See Mullions, page 27.

#### Shim Kit

Optional for mounting device over raised vision light molding; specify M58.

#### Applications and Listings

See page 3.

#### Warranty

Five-year limited.

### Certification/Compliance

#### ANSI

Meets A156.3, Type 4 or 28, Grade 1.  
Meets A117.1 Accessibility Code.

#### UL/cUL

All devices listed for safety as panic hardware; devices comply with UL 305 standards for panic hardware. UL symbol on active case cover indicates listing.

#### California State Reference Code

This product has been approved by the California State Fire Marshal pursuant to section 13144.1 of the California Health and Safety Code.

#### NFPA

All exit devices comply with NFPA 101 Life Safety Code.

#### ADA

Exit devices, lever trims and pulls comply with Americans with Disabilities Act.

### Finishes

BHMA 605	Bright Brass	
BHMA 606	Satin Brass	
BHMA 611	Bright Bronze	
BHMA 612	Satin Bronze	
BHMA 613	Oxidized Bronze, oil rubbed, available lacquered	
BHMA 613E	Dark Oxidized Satin Bronze Equivalent	
BHMA 618	Bright Nickel Plated	
BHMA 619	Satin Nickel Plated	
BHMA 625	Bright Chromium Plated	
BHMA 626* (Trim Only)	Satin Chromium Plated	
626C	Satin Chromium Plated with MicroShield®	
BHMA 629	Bright Stainless Steel	
BHMA 630	Satin Stainless Steel	
630C	Satin Stainless Steel with MicroShield®	
BHMA 722	Black oxidized bronze, oil rubbed	

\*Contact factory for devices required in BHMA 626

# SecureBolt® Features

## ED4000

### ED4200S SecureBolt® Exit Device

3/4" (19mm) projection x 1" wide deadbolt-style latchbolt with positive deadlocking by auxiliary bolt

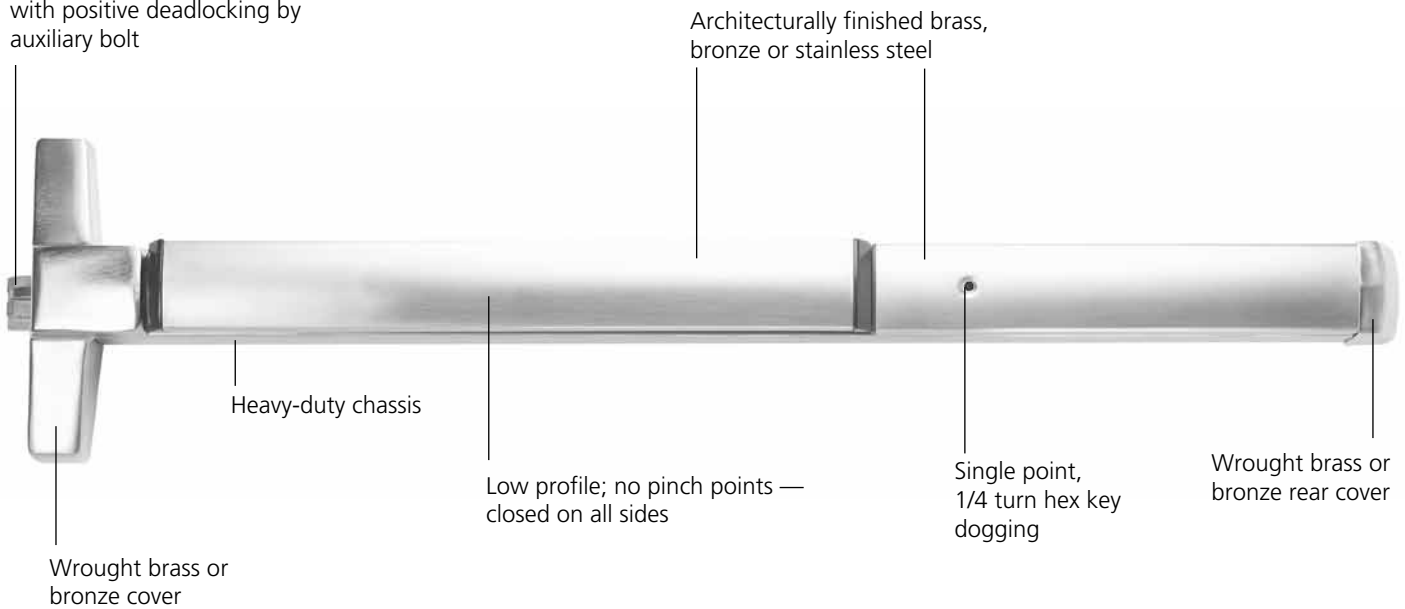

### Vector Forces

In terms of an exit device, vector forces mean that pressure applied to the door results in a force against the stop and the frame, resulting in door/frame separation. The standard pullman latchbolt applies 280 pounds of force against the frame from a 400-pound pull on the door.

The SecureBolt® exit device only applies 63 pounds of force against the frame from a 400-pound pull on the door. Less force means the door and frame do not separate, providing a higher level of security, as the door cannot be pulled open.

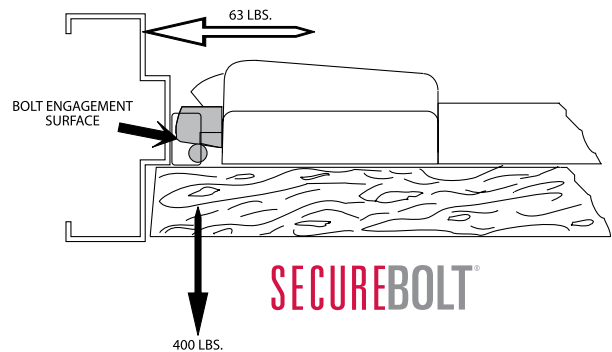
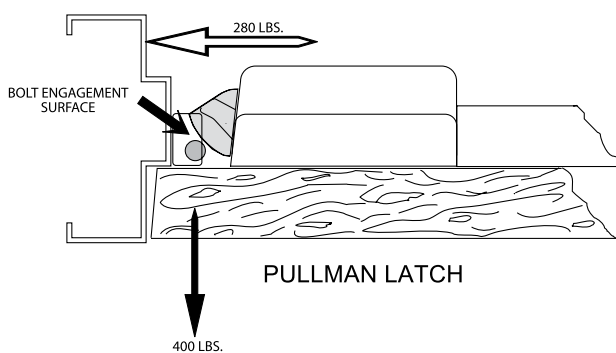



# Rim Features

## ED4000



### ED4200 Narrow Stile Rim Exit Device

#### Features

##### Handing

Device non-handed.  
Trim handed.

##### Bar Length

Easily field cut to size.  
Standard: 36" (914mm) bar fits 30" - 36" (762mm-914mm) door.  
Optional: 24" (610mm) bar fits 24" (610mm) door; specify W024.  
Optional: 48" (1219mm) bar fits 36" - 48" (914mm-1219mm) door; specify W048.

##### Door Thickness

1-3/4" (44mm) standard.  
Optional: 2" (51mm); specify D200.  
Optional: 2-1/4" (57mm); specify D214.

##### Stile

Minimum width 2" (51mm).

##### Latchbolt

3/4" (19mm) throw, pullman type with stainless steel deadlocking latch.

##### Materials

Heavy-duty cold-forged steel chassis; heavy-gauge steel mechanisms, electroplated for corrosion resistance; finished parts are brass, bronze or stainless steel; stainless steel springs; nylon bearings.

##### Projection

3-1/4" (83mm) active, 2-3/4" (70mm) dogged.

##### Dogging

Standard: single point 1/4 turn hex key dogging.  
Optional: less dogging; specify M51.  
Optional: cylinder dogging; specify M52.  
Optional: electric dogging; specify M97.

##### Fasteners

Standard: machine screws.  
Optional: sex nuts and bolts; specify M54.

##### Strike

Surface mounted 3/8" (10mm) diameter roller strike, complete with positive locking plate and shims.

#### Functions and Trims

Through-bolted lever, knob, pull, thumbturn and thumbpiece trims available with wide range of functions; see Trims and Functions, page 14.

#### Cylinders

Cylinder not included unless specified. See Quick Codes, page 32.

#### Removable Mullion

See Mullions, page 27.

#### Shim Kit

Optional for mounting device over raised vision light molding; specify M58.

#### Applications and Listings

See page 3.

#### Warranty

Five-year limited.

#### Certification/Compliance

##### ANSI

Meets A156.3, Type 4, Grade 1.  
Meets A117.1 Accessibility Code.

##### UL/cUL

All devices listed for safety as panic hardware; devices comply with UL 305 standards for panic hardware. UL symbol on active case cover indicates listing.

##### California State Reference Code

This product has been approved by the California State Fire Marshal pursuant to section 13144.1 of the California Health and Safety Code.

##### NFPA

All exit devices comply with NFPA 101 Life Safety Code.

##### ADA

Exit devices, lever trims and pulls comply with Americans with Disabilities Act.

#### Finishes

BHMA 605	Bright Brass	
BHMA 606	Satin Brass	
BHMA 611	Bright Bronze	
BHMA 612	Satin Bronze	
BHMA 613	Oxidized Bronze, oil rubbed, available lacquered	
BHMA 613E	Dark Oxidized Satin Bronze Equivalent	
BHMA 618	Bright Nickel Plated	
BHMA 619	Satin Nickel Plated	
BHMA 625	Bright Chromium Plated	
BHMA 626* (Trim Only)	Satin Chromium Plated	
626C	Satin Chromium Plated with MicroShield®	
BHMA 629	Bright Stainless Steel	
BHMA 630	Satin Stainless Steel	
630C	Satin Stainless Steel with MicroShield®	
BHMA 722	Black oxidized bronze, oil rubbed	

\*Contact factory for devices required in BHMA 626

# Rim Features

## ED4000

### ED4200 Narrow Stile Rim Exit Device

3/4" (19mm) throw pullman type  
latchbolt with auxiliary deadlocking  
latch standard

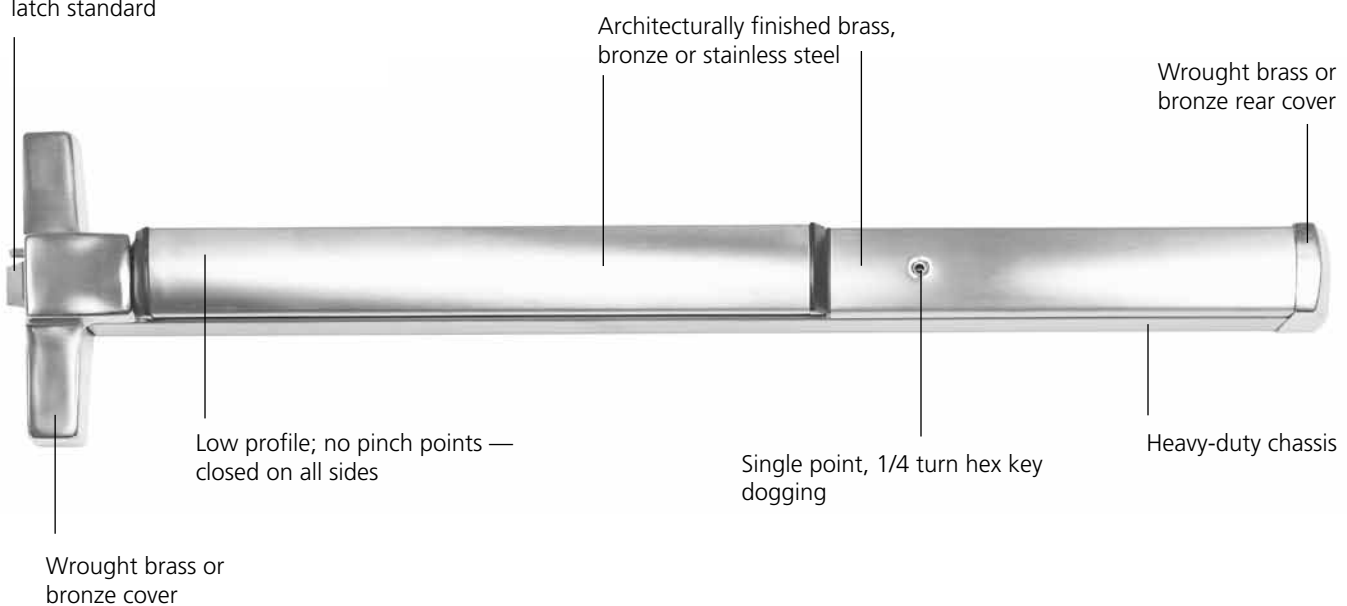

# Surface Vertical Rod Features

ED4000

## ED4400 Narrow Stile Surface Vertical Rod Exit Device

### Features

#### Handing

Device is handed but easily field reversible.  
Trim handed.

#### Bar Length

Easily field cut to size.

Standard: 36" (914mm) bar fits 30" - 36" (762mm-914mm) door.

Optional: 24" (610mm) bar fits 24" (610mm) door; specify W024.

Optional: 48" (1219mm) bar fits 36" - 48" (914mm-1219mm) door; specify W048.

#### Door Thickness

1-3/4" (44mm) standard.

Optional: 2" (51mm); specify D200.

Optional: 2-1/4" (57mm); specify D214.

#### Stile

Minimum width 2" (51mm).

#### Door Height

Standard: Top rod for 7' door.

All top rods easily field cut to size.

Optional door heights available; see Quick Codes, page 32.

#### Latchbolt

Top: 3/4" (19mm) throw, pullman type with automatic deadlatching.

Bottom: 5/8" (16mm) throw deadbolt, held retracted during door swing.

#### Vertical Rods

1/2" O.D. tubular brass, bronze or stainless steel with rod guides.

#### Materials

Heavy-duty cold-forged steel chassis; heavy-gauge steel mechanisms, electroplated for corrosion resistance; finished parts are brass, bronze or stainless steel; stainless steel springs; nylon bearings.

#### Projection

3-1/4" (83mm) active, 2-3/4" (70mm) dogged.

#### Dogging

Standard: single point 1/4 turn hex key dogging.

Optional: less dogging; specify M51.

Optional: cylinder dogging; specify M52.

Optional: electric dogging; specify M97.

#### Fasteners

Standard: machine screws.

Optional: sex nuts and bolts; specify M54.

#### Strike

Top: Adjustable roller strike with positive locking plate and shims.

Bottom: flush mounted.

Optional strikes available; see Options and Accessories, page 28.

#### Functions and Trims

Through-bolted lever, knob, pull, thumbturn and thumbpiece trims available with wide range of functions; see Trims and Functions, page 14.

#### Cylinders

Cylinder not included unless specified. See Quick Codes, page 32.

#### Shim Kit

Optional for mounting device over raised vision light moding; specify M58.

#### Applications and Listings

See page 3.

#### Warranty

Five-year limited.

### Certification/Compliance

#### ANSI

Meets A156.3, Type 5, Grade 1.

#### UL/cUL

All devices listed for safety as panic hardware; devices comply with UL 305 standards for panic hardware. UL symbol on active case cover indicates listing.

#### California State Reference Code

This product has been approved by the California State Fire Marshal pursuant to section 13144.1 of the California Health and Safety Code.



#### NFPA

All exit devices comply with NFPA 101 Life Safety Code.

#### ADA

Lever trims and pulls comply with Americans with Disabilities Act.

### Finishes

BHMA 605	Bright Brass
BHMA 606	Satin Brass
BHMA 611	Bright Bronze
BHMA 612	Satin Bronze
BHMA 613	Oxidized Bronze, oil rubbed, available lacquered
BHMA 613E	Dark Oxidized Satin Bronze Equivalent
BHMA 618	Bright Nickel Plated
BHMA 619	Satin Nickel Plated
BHMA 625	Bright Chromium Plated
BHMA 626* (Trim only)	Satin Chromium Plated
626C	Satin Chromium Plated with MicroShield® 
BHMA 629	Bright Stainless Steel
BHMA 630	Satin Stainless Steel
630C	Satin Stainless Steel with MicroShield® 
BHMA 722	Black oxidized bronze, oil rubbed

\*Contact factory for devices required in BHMA 626

# Surface Vertical Rod Features

## ED4000

### ED4000 Surface Vertical Rod Exit Device

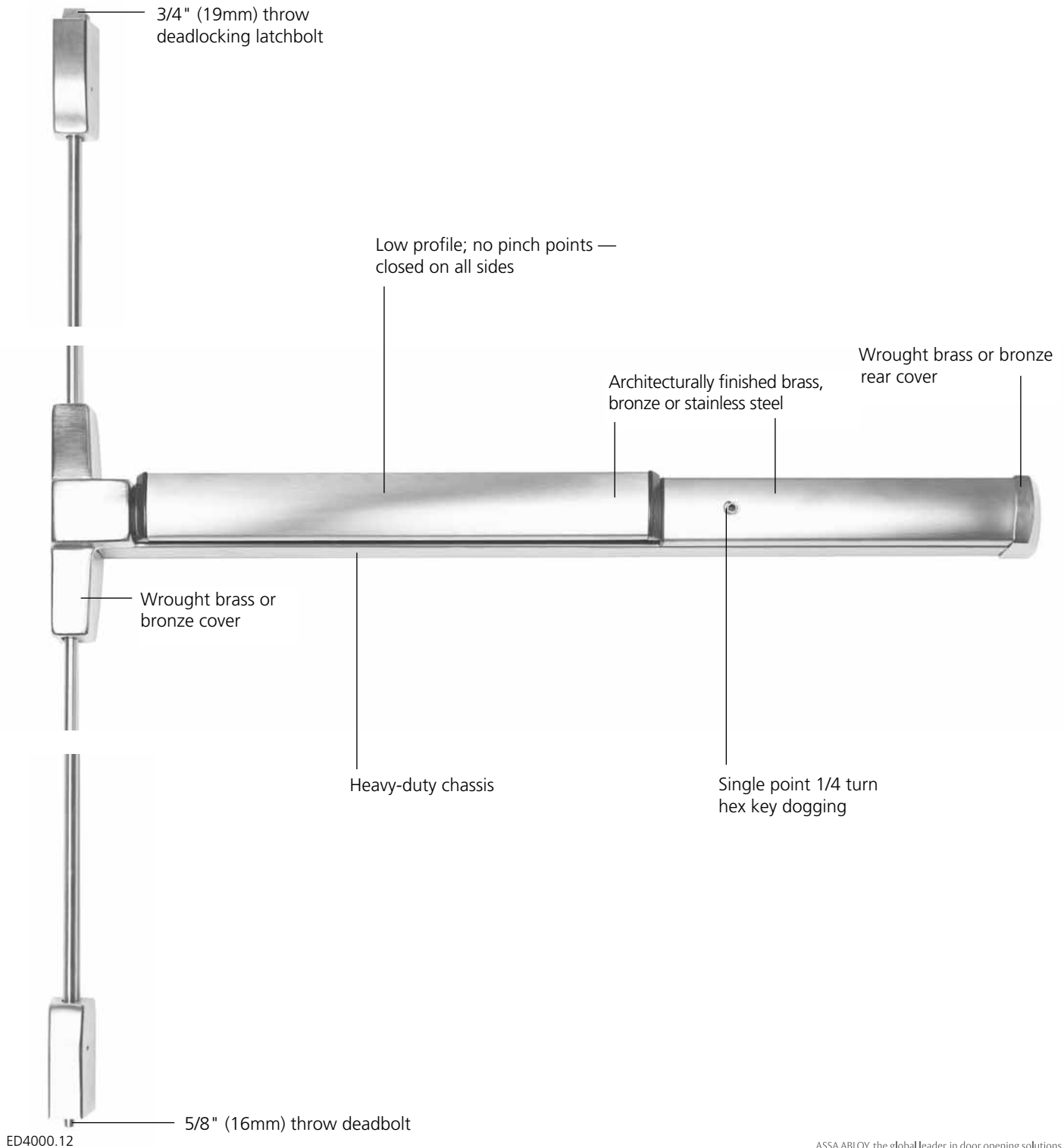

# Concealed Vertical Rod Features

ED4000

## ED4800 Narrow Stile Concealed Vertical Rod Exit Device



### Features

#### Handing

Device handed but easily field reversible.  
Lever trim handed.

#### Bar Length

Easily field cut to size.  
Standard: 36" (914mm) bar fits 30" - 36" (762mm-914mm) door.  
Optional: 24" (610mm) bar fits 24" (610mm) door; specify W024.  
Optional: 48" (1219mm) bar fits 36" - 48" (914mm-1219mm) door; specify W048.

#### Door Thickness

1-3/4" (44mm) standard.  
Optional: 2" (51mm); specify D200.  
Optional: 2-1/4" (57mm); specify D214.

#### Stile

Minimum width 2" (51mm).

#### Door Height

Standard: Top rod for 8' door.  
Telescoping rod assembly to accommodate various door heights.  
Optional door heights available; see Quick Codes, page 32.

#### Latchbolt

Top: 3/4" (19mm) throw, pullman type with automatic deadlatching.  
Bottom: 5/8" (16mm) throw deadbolt, held retracted during door swing.

#### Vertical Rods

1/2" O.D. tubing, electroplated for corrosion resistance.

#### Materials

Heavy-duty cold-forged steel chassis; heavy-gauge steel mechanisms, electroplated for corrosion resistance; finished parts are brass, bronze or stainless steel; stainless steel springs; nylon bearings.

#### Projection

3-1/4" (83mm) active, 2-3/4" (70mm) dogged.

#### Dogging

Standard: single point 1/4 turn hex key dogging.  
Optional: less dogging; specify M51.  
Optional: cylinder dogging; specify M52.  
Optional: electric dogging; specify M97.

#### Fasteners

Standard: machine screws.  
Optional: sex nuts and bolts; specify M54.

#### Strike

Top: adjustable roller strike with positive locking plate and shims.  
Bottom: flush mounted.  
Optional strikes available; see Options and Accessories, page 28.

#### Functions and Trims

Through-bolted lever, knob, pull, thumbturn and thumbpiece trims available with wide range of functions; see Trims and Functions, page 14.

#### Cylinders

Cylinder not included unless specified. See Quick Codes, page 32.

#### Shim Kit

Optional for mounting device over raised vision light moding; specify M58.

#### Applications and Listings

See page 3.

#### Warranty

Five-year limited.

### Certification/Compliance

#### ANSI

Meets A156.3, Type 6, Grade 1.  
Meets A117.1 Accessibility Code.

#### UL/cUL

All devices listed for safety as panic hardware; devices comply with UL 305.  
UL symbol on active case cover indicates listing.

#### California State Reference Code

This product has been approved by the California State Fire Marshal pursuant to section 13144.1 of the California Health and Safety Code.

#### NFPA

All exit devices comply with NFPA 101 Life Safety Code.

#### ADA

Exit devices, lever trims and pulls comply with Americans with Disabilities Act.

### Finishes

BHMA 605	Bright Brass	
BHMA 606	Satin Brass	
BHMA 611	Bright Bronze	
BHMA 612	Satin Bronze	
BHMA 613	Oxidized Bronze, oil rubbed, available lacquered	
BHMA 613E	Dark Oxidized Satin Bronze Equivalent	
BHMA 618	Bright Nickel Plated	
BHMA 619	Satin Nickel Plated	
BHMA 625	Bright Chromium Plated	
BHMA 626* (Trim only)	Satin Chromium Plated	
626C	Satin Chromium Plated with MicroShield®	
BHMA 629	Bright Stainless Steel	
BHMA 630	Satin Stainless Steel	
630C	Satin Stainless Steel with MicroShield®	
BHMA 722	Black oxidized bronze, oil rubbed	

\*Contact factory for devices required in BHMA 626

# Concealed Vertical Rod Features

## ED4000

### ED4800 Concealed Vertical Rod Panic Exit Device

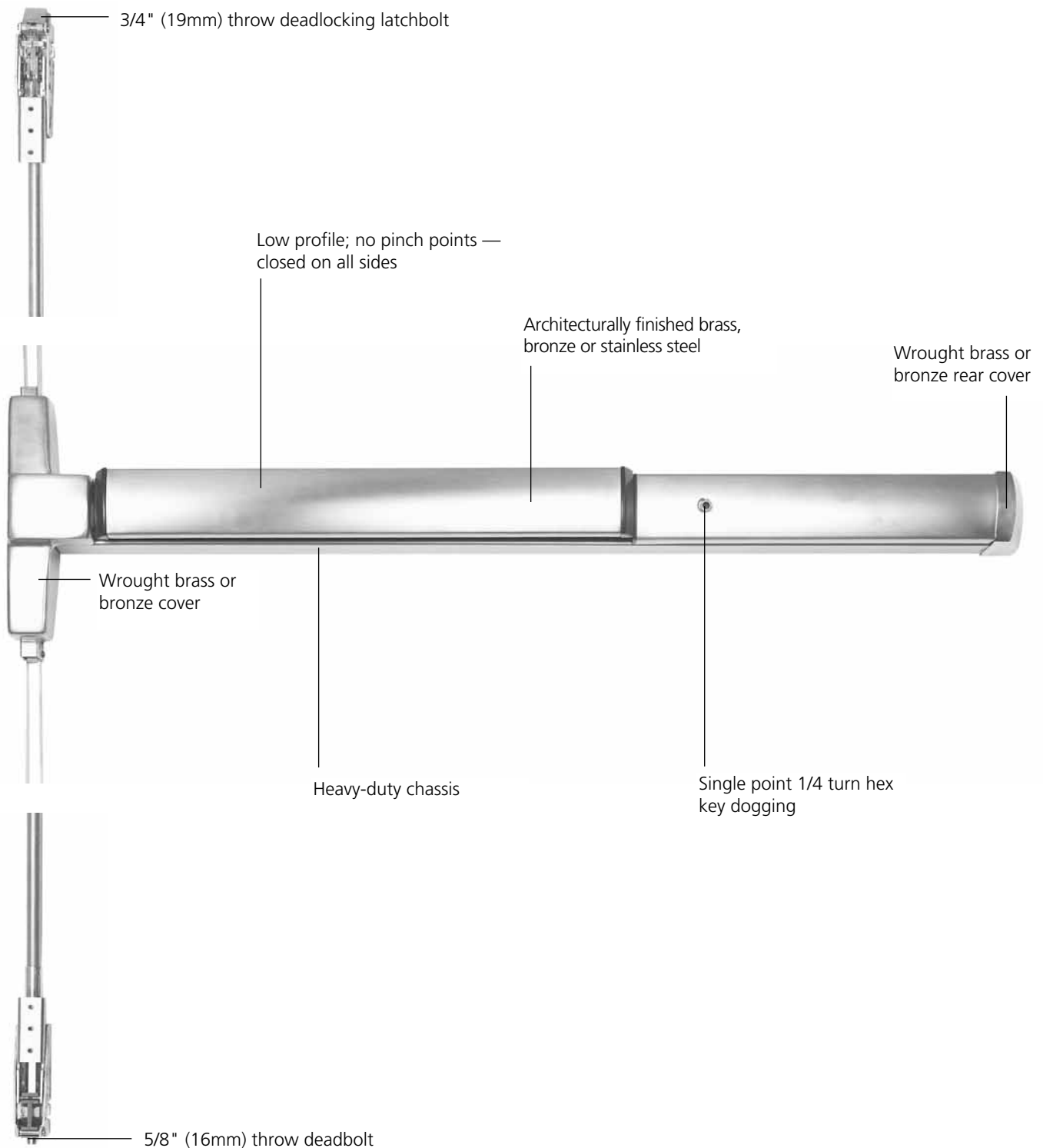











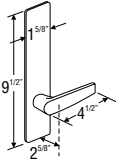

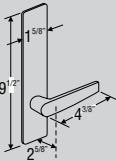

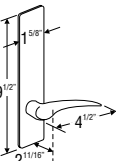

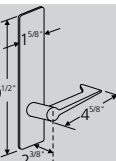
# Trims and Functions

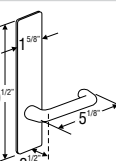
## ED4000

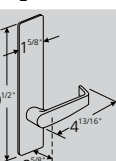
### Features:

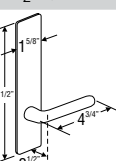
- Fourteen architectural finishes
- Lever designs allow for design continuum with Corbin Russwin line
- 1-year limited warranty

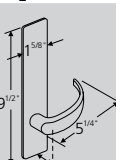









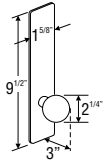

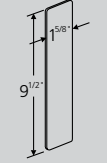

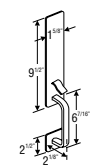
Trim Designs			Passage ANSI No. 14	Dummy ANSI No. 02	Classroom* ANSI No. 08	Storeroom ANSI No. 09	
	<b>Armstrong A8</b> Lever: Cast Escutcheon: Wrought Cylinder: Rim			A810	A850	A855	A859
	<b>Citation C8</b> Lever: Cast Escutcheon: Wrought Cylinder: Rim			C810	C850	C855	C859
	<b>Dirke D8</b> Lever: Cast Escutcheon: Wrought Cylinder: Rim			D810	D850	D855	D859
	<b>Essex E8</b> Lever: Cast Escutcheon: Wrought Cylinder: Rim			E810	E850	E855	E859
	<b>Lustra L8</b> Lever: Cast Escutcheon: Wrought Cylinder: Rim			L810	L850	L855	L859
	<b>Newport N8</b> Lever: Cast Escutcheon: Wrought Cylinder: Rim			N810	N850	N855	N859
	<b>Regis R8</b> Lever: Cast Escutcheon: Wrought Cylinder: Rim			R810	R850	R855	R859
	<b>Princeton PR8</b> Lever: Cast Escutcheon: Wrought Cylinder: Rim			PR810	PR850	PR855	PR859

# Trims and Functions

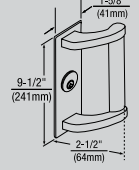
## ED4000

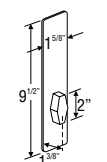
### Features:

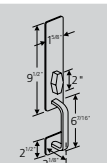
- Fourteen architectural finishes
- Lever designs allow for design continuum with Corbin Russwin line
- 1-year limited warranty

Trim Designs		Passage ANSI No. 14/15/16	Dummy ANSI No. 02	Classroom ANSI No. 05/08/11	Storeroom/Night- latch ANSI No. 03/06/09/12
	<b>Global G8</b> Knob: Wrought Escutcheon: Wrought Cylinder: Rim		G810 (14)	G850	G855 (08)  G859 (09)
	<b>Plate F4</b> Plate: Wrought Cylinder: Rim		N/A	F450 <sup>2</sup>	N/A  F457 <sup>2</sup> (03)
	<b>Pull/Thumbpiece T14</b> Pull: Cast Escutcheon: Wrought Cylinder: Rim		T1410 (15)	 T1450 <sup>1,2</sup>	 T1455 (05)  T1457 <sup>1,2</sup> (06)
	<b>Pull P10</b> Pull: Extruded Escutcheon: Wrought Cylinder: Rim	 	N/A	P1050 <sup>2</sup>	N/A  P1057 <sup>2</sup> (03)
	<b>Plate x Thumbturn O8</b> Plate: Wrought Thumbturn: Cast Cylinder: Rim		O810 (16)	N/A	O855 (11)  O859 (12)
	<b>Pull x Thumbturn O14</b> Pull: Cast Thumbturn: Cast Cylinder: Rim		O1410 (16)	N/A	O1455 (11)  O1459 (12)
	<b>Key Only K1</b>  Note: Available with cylinder option only. Ex: K157 x 6P		N/A	N/A	N/A  K157 <sup>2</sup> (03)

Note: Classroom function trims can be converted to Storeroom function by a simple field adjustment.









1. Pull only, no thumbpiece.

2. Not recommended for use with surface or concealed vertical rod exit devices.

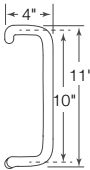

# Utility Trims and Functions

ED4000

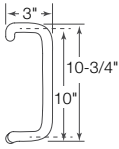
Offset Pull Trim: P12, P13, P14*				
	<b>Offset Pull P12</b> Clearance: 2-1/2"			Specify Part Number, 716F50M x Finish <sup>1</sup>
	<b>Offset Pull P13</b> Clearance: 2-1/2"			Specify Part Number, 716F51M x Finish <sup>1</sup>
	<b>Offset Pull P14</b> Clearance: 2-1/2"			Specify Part Number, 716F52M x Finish <sup>1</sup>

1. Available in 605, 606, 612, 613, 626, 629 and 630 finishes.  
 \*Available on 1-3/4" thick doors only.

# Electrified Exit Devices

## ED4000

### Electrified Exit Devices

The Corbin Russwin ED4000 series electrified exit devices offer a complete range of options that may be integrated into the monitoring security and alarm systems of most buildings. The continuum of appearance is maintained, as well as the security and function of the ED4000 mechanical exit device.



List No.	Exit Device Description	Available Options						
		M61	M91	M92	M93	M94	M97	D
ED4200	Rim Exit Device	x	x	x	x	x	x	x
ED4200S	Rim SecureBolt® Device	x	x	x	x	x	x	x
ED4400	Surface Vertical Rod	x	x	x	x	x	x	x
ED4800	Concealed Vertical Rod	x	x	x	x	x	x	x

### Electrified Hardware Option Descriptions

M61	Alarm Option
M91	Bolt Monitor
M92	Touchbar Monitor
M93	Trim Monitor
M94	Electric Latch Pullback
M97	Electric Dogging
D	Delayed Egress

#### Notes:

- The following options cannot be ordered together on the same device:
  - D x M52                      M52 x M61
  - D x M61                      M52 x M97
  - D x M92                      M61 x M92
  - D x M94                      M94 x M97
  - D x M97                      ED4400 x M61 with Monitors M91, M92 or M93
- When ordering a Surface Vertical Rod exit device with the D option (ED4400D), rod and latch quards (provided by others) must be used.

\* Add as suffix to exit device.  
Example: ED5400D x 630 x RHR

# Electrified Exit Devices

ED4000

## Electric Latch Pullback - M94

Continuous-duty solenoid retracts the latchbolt(s) for momentary or maintained periods of time. Latch Pullback provides a remote means of unlocking exit devices.

### Application

SecureBolt® Exit Devices  
Rim Exit Devices  
Surface Vertical Rod Exit Devices  
Concealed Vertical Rod Exit Devices

### Listings

UL listed for Panic Exit Hardware.

### Electrical Specifications

Requires 782 Controller (120VAC input, output sequencer for one or two devices). No substitutes; using other power sources voids warranty. Requires a 4-wire electrical transfer pivot or hinge. See page 21 for controller information.

### Solenoid

A dual retraction/holder type solenoid.

10 Amp in rush @ 24VDC to 28VDC  
(.25Amp holding-continuous duty.)

Device bolts remain retracted for as long as the device is energized. Removal of power returns the device to the life safety, self-latching mechanical mode.

Interface with central or local fire alarm system, automatic door operators, access control systems, security alarm systems, and blow open door systems.

**Note:** This feature is not available with electric dogging (M97) or delayed egress (D) on the same device.

### Ordering

Specify quick code M94.

## Electric Dogging - M97

This electronic feature will provide continuous dogging when power is applied and the push bar is depressed manually. Interruption or removal of the power will release the pushbar and return the exit device back to normal operation.

### Application

SecureBolt® Exit Devices  
Rim Exit Devices  
Surface Vertical Rod Exit Devices  
Concealed Vertical Rod Exit Devices

### Listings

UL listed for Panic Exit Hardware.

### Electrical Specifications

.35 Amps @ 24VDC-28VDC continuous duty (2) 36 volt holding magnets holding force (86 lbf. total)

**Note:** This feature is not available with latch pullback (M94), delayed egress (D) or cylinder dogging (M52) on the same device.

### Ordering

Specify quick code M97.

# Electrified Exit Devices

## ED4000

### Delayed Egress Exit Device

The delayed egress option provides additional security and safety in a strong line of panic hardware. The delayed egress exit device is an electromechanical device used to secure interior or exterior openings. The option is available for rim, SecureBolt® and concealed vertical rod devices in all standard finishes.

### Operation

The exit door is normally closed and latched. The Delayed Egress Exit Device "D" secures the door in the locked mode with the solid Red LED indicating locked mode status. Depressing the push pad for less than 3 seconds will sound the nuisance beep without initiating the alarm. Depressing the pushpad for 3 seconds or longer will initiate an irreversible local audible beeping tone and a visual amber indicator until the device releases. The person depressing the exit bar is denied egress for 15 or 30 seconds and security personnel are alerted. After the delay time of 15 or 30 seconds the device releases, the LED changes to Green, and the alarm changes to a steady tone which continues to alarm until manually reset by key. The remote monitoring contact outputs can be used to alert security personnel.

**Note:** The 15-second time delay is standard. 30-second time delay is optional (may be accepted by local jurisdiction).

### Applications

- For use on hollow metal interior or exterior doors.
- Complies with NFPA 101 "Code For Safety To Life From Buildings And Structures" by National Fire Protection Association.
- BOCA options available to comply with National Building Code requirements. BOCA option is not suitable for installations in accordance with NFPA 101.
- 1-3/4" door thickness standard; 2" and 2-1/4" optional; specify D200 or D214 when ordering.
- Standard 36" device fits 36" doors only. Device cannot be cut less than 36".
- Option W048 fits doors 42" – 48". Devices cannot be cut less than 42".



### Listing

- UL/cUL Listed
  - Controlled Exit Panic Devices (FULA/FULA7)
  - Special Locking Arrangements (FWAX/FWAX7)
- BHMA (ANSI A156.3 and ANSI A156.24) Directory of Certified Exit Devices

### Specifications

Input Voltage: 24VDC (+/- 10%) Regulated and filtered.

### Power Consumption

- Standard Device: 500 mA

### Standard Features

#### Key Switch Operation:

- Normal: The system is armed by applying power to the device (solid Red LED). Depressing the pushpad for more than the nuisance delay time starts the exit delay cycle.
- Bypass: Turning the key switch clockwise to the bypass position allows immediate egress without alarming. The bar functions as a standard exit device. (Red LED flashes slow.)
- Reset/Delay: Used to reset device after the factory set 15 or optional 30-second delay cycle has timed out. If the device is armed, turning the key switch counterclockwise to the reset mode will release the device without alarm for egress and will rearm after 10 seconds. (Red LED flashes quickly.)

#### Local Visual Status Indicator:

- RED: The exit device is secure and the delayed egress circuitry is energized.
- AMBER: The egress cycle has started, indicated by an irreversible local audible beeping tone.
- GREEN: Exit device is in alarm and has released.

### Nuisance Delay Time:

Depressing for less than 3 seconds sounds an audible beep without activating the irreversible alarm sequence. (Immediate alarm can be selected by removing a jumper on the control board.)

### Internal Alarm Siren:

When the exit device is armed, depressing the push pad initiates the internal 85db alarm siren.

### Remote Control Inputs:

- Remote Reset: Accepts a momentary contact (keyswitch, pushbutton, etc.) to reset the unit during alarm or allows momentary egress (10 seconds) when the unit is armed.
- Remote Bypass: Accepts a momentary contact to put the unit in a maintained bypass operation. The exit device functions as a standard device.

### Alarm Outputs:

Two sets of normally open and normally closed contacts. Contacts change only during alarm status. One set of contacts changes when device delay cycle has started (Alarm). One set of contacts changes when device has released (Secure).

### Door Sign:

Door sign per code included.

**Note:** This feature is not available with, M52 Cylinder Dogging, M61 Alarm Option, M92 Touchbar Monitor, M94 Electric Latch Pullback, M97 Electric Dogging

### How to Order

Specify "D" suffix after device. Example: ED4200SD

# Electrified Exit Devices

ED4000

## Options

### Bolt Position Monitor M91:

SPDT (Single Pole Double Throw) switch that monitors the position of the latchbolt or vertical rods. To order, specify M91.

### Outside Trim Monitor M93:

Used when outside trim is desired to be used with an external door position switch (by others) input. This switch will allow Bypass (disarms device) when the trim is used for ingress. The device requires setting after entry by means of the keyswitch on the device or a remote switch. To order, specify M93.

**Note:** If an external DPS is not used, standard trim will allow entry without affecting the device in an armed mode. The device will only be affected when the touchbar is depressed.

### NFPA 101 Requirements: 30 Second Delay M88

Upon depressing the pushpad for 3 seconds or longer, the device will sound an audible beeping tone and allow the door to be opened after 30 seconds. The tone will then change to a continuous alarm until reset. Resetting of the alarm and re-arming of the device is accomplished by manual means only. To order, specify M88.

**Note:** Where approved by the authority having jurisdiction, a delay not exceeding 30 seconds shall be permitted.

## BOCA Requirements:

### BOCA 15 Second Delay M89

### BOCA 30 Second Delay M90

Upon depressing the pushpad for 1 second or longer, the device will sound an audible beeping tone and allow the door to be opened within 15 (or 30) seconds. The tone will then change to a continuous alarm until rest. Resetting of the alarm and re-arming of the device occurs automatically once the door has been returned to the closed position for 30 seconds. The 30-second re-arming timer will re-start if the pushpad is depressed or the door is re-opened before actual re-arming of the device occurs. A DPS (Door Position Switch) is required for the BOCA option. To order, specify M89 (BOCA 15 second) or M90 (BOCA 30 second).

**Note:** BOCA option is not suitable for installations in accordance with NFPA 101.

## Required Accessories

### Power Supply:

A regulated and filtered power supply with a Fire Alarm interface is required.

1 Amp minimum @ 24VDC per device.

Special options will require more amperage. Consult factory.

To order, specify:

- BPS-24-1 (1 AMP)
- BPS-24-2 (2 AMP)
- BPS-24-4 (4 AMP)

### Power Transfer:

Allows the power to make the transition from frame to door without pinching or removal of insulation. Optional power transfer: EPTL – concealed transfer for up to and over 120° swing doors. To order specify Part No. 704F28. Consult catalog for additional recommended power supplies and accessories.



EPTL  
Power  
Transfer

EPT  
Doors up  
to 120°  
swing.

## Trims

See Trims and Functions, pages 14-15.

## Cylinders

Utilizes a 1-1/8" mortise cylinder with an A02 cam. Cylinder not included unless specified. See Quick Codes, page 32.

## Warranty

Exit devices carry a five-year limited warranty. Electronic components carry a two-year limited warranty. Trim carries a one-year limited warranty.

# Electrified Exit Devices

## ED4000

### M61 Option and ED40AK Alarm Kit



#### Activation

Alarm is armed by turning key clockwise. Low audible chirp indicates alarm has been activated. 20-second delay allows egress before alarm is set (selectable, 7, 10, 15 and 20) Alarm will sound when the exit device pushpad is depressed.

#### Continuous Alarm Mode

Alarm sounds continuously when the exit device pushpad is depressed. Alarm must be manually reset by keyswitch. Dip switch setting allows auto reset from 2, 5 or 10 minutes. LED flashes after device has reset.

#### Low Battery Warning

Audible chirp every 30 seconds.

#### Warning Decal

"EMERGENCY EXIT-ALARM WILL SOUND" provided.

#### REX and Passage Delay

A 7, 10, 15 or 20-second delay (after arming) permits egress (by turning key clockwise).

#### Alarm Shunt

Shunt alarm input for devices with signal, outside trim monitors (M91 & M93) or card access.

#### Power Requirements

One 9-volt battery (included).

#### Alarm Strength

105db @ 10 feet.

#### Arm/Disarm

Requires one 1-1/8" mortise cylinder with an A02 cam. Clockwise turn arms the alarm, counterclockwise turn disarms or silences the alarm. Low audible chirp indicates alarm has been activated.

#### Device Status

A Red LED indicator will illuminate every 30 seconds when the alarm is armed. DIP switch allows LED to be changed to green if desired.

#### Tamper Resistant

Built-in safety monitor sounds alarm when tampering occurs.

#### Cylinders

Cylinder not included unless specified. See How to Order, page 32.

#### Door Width

Available for 36"-48" devices only. Not available with devices less than 36". 48" device can be cut to fit 42" door.

#### Quick Code

M61

#### Kit

Available in kit form for field retrofit. Order ED40AK.

#### Hard Wired Option

A hard wired option is available by using a 9VDC output power supply and a remote power harness. Specify 784 to order the 9VDC output power supply. See page 42 for 784 power supply information. Specify 709F989 to order the remote power harness for a 36" device and specify 709F999 to order the remote power harness for a 48" device.

#### Exceptions

Dogging not available with M61 option and ED40AK alarm kit. The ED40AK for the ED4000 series exit devices cannot be retrofitted in the field to ED4400 series surface vertical rod exit devices.

The alarm option is available for the surface vertical rod devices by factory order only. To order, add the quick code

suffix M61 to the device number; for example, ED4400 x M61.

Please note, in accordance with Corbin Russwin's standard limited warranty, any attempt to retrofit the ED40AK to a surface vertical rod exit device will void the warranties for these products.

Surface vertical rod exit devices with M61 alarm option cannot be ordered with M91, M92 or M93 monitors.

M61 alarm option is not available with delayed egress (D).

### How to Order

#### Ordering example for Exit Device

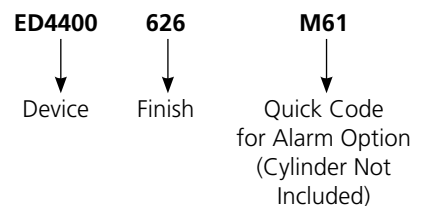

#### Ordering Example for Alarm Kit Only

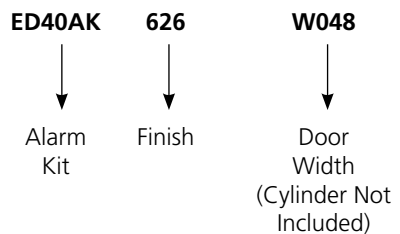

# Electrified Exit Devices

ED4000

## 782 Series Controller

### Operation

Designed to control one or two electric latch pullback M94 exit devices. Equipped with two 20-second timers which can operate the exit devices together or independently. Requires a momentary or timed, dry contact input and can be interfaced with access control systems, automatic door operators, "blow open" applications and has provisions for Fire Alarm systems.

### Features

- 2 control inputs. Accepts normally closed dry contacts for device activation from a keyswitch, pushbutton, access control or fire alarm system.
- 2 normally open control outputs for automatic door operators
- 2 M94 device outputs
- Fire Alarm Interface input
- 24VDC output for audible or LEADS .25 Amp

### Wiring

Up to 40 feet: 16 AWG wire

Up to 60 feet: 14 AWG wire

Up to 100 feet: 12 AWG wire

### Electrical Specifications

- 120VAC 60Hz 750mA (Max)
- 10 Amp inrush

### Listings

UL 294

UL Class 2 Outputs

**Note:** The 782 is the only power source to be used with the M94 option. Using any other power supply will void the warranty and cause possible damage to the exit device.

### Ordering

782 Controller

## BPS-24-2 Power Supply

Provides 2 Amps of output current at 24VDC and can control a total of 5 Electric Dogging Devices. A separate switching device (key switch or push button) must be used to control the locking device.

### Specifications

- 120VAC Input Power
- 24VDC @ 2 Amp Output
- Fire Alarm Interface

## BPS-24-4 Power Supply

Provides 4 Amps of output current at 24VDC and can control a total of 10 Electric Dogging Devices. A separate switching device (keyswitch or push button) must be used to control the locking device.

### Specifications

- 120VAC Input Power
- 24VDC @ 4 Amp Output
- Fire Alarm Interface

## EPTL

Concealed power transfer for over 120° swing doors. Installs in door and frame edges. Supports wires up to .25" (6mm) thick, and works with doors hung with butt hinges, continuous hinges and pivots. To order, specify Part No. 704F288.



## 782 Series Controller

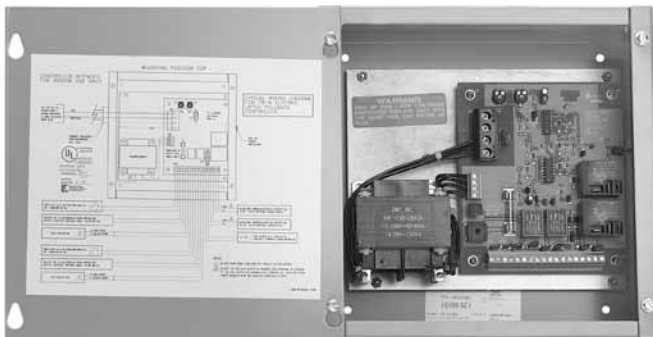

# Electrified Options & Accessories

## ED4000

### Monitors - M91, M92, M93

#### Operation

Monitors are used to indicate the authorized and unauthorized use of an opening or to signal and control other opening hardware, such as magnetic locks. Each monitoring device is equipped with one internal single-pole double-throw (SPDT) switch per monitor.

#### Bolt Position Monitoring - M91

Provides indication of the position of the deadlatch or vertical rods. Used with security systems to monitor the deadlatch in rim, SecureBolt® devices and rods in CVR & SVR devices.

##### Application

See chart on page 16.

##### Listings

UL listed for Panic Exit Hardware.

##### Electrical Specifications

5 Amps @ 28VDC SPDT contacts.

##### Ordering

Specify quick code M91.

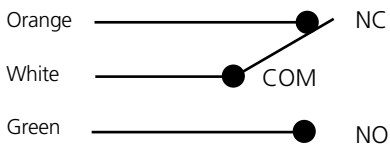

#### Touchbar Monitoring - M92

Provides indication of the pushpad being depressed. Used as a request to exit to shunt alarm systems, release electromagnetic locks or monitor egress.

##### Application

See chart on page 16.

##### Listings

UL listed for Panic Exit Hardware.

##### Electrical Specifications

4 Amps @ 250 VAC SPDT contacts.

##### Ordering

Specify quick code M92.

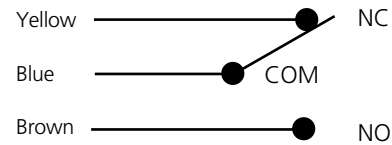

#### Outside Monitoring or Signaling - M93

Provides indication of the device being operated from the outside. Used as a request to enter signal switch to shunt alarms; also used to monitor entry.

##### Application

See chart on page 16.

##### Listings

UL listed for Panic Exit Hardware.

##### Electrical Specifications

5 Amps @ 28VDC SPDT contacts.

##### Ordering

Specify quick code M93.

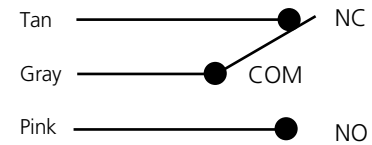



# Electrified Options & Accessories

ED4000

## BPS Power Supply

### Operation

Power supplies are designed to provide reliable filtered and regulated power for long life to a variety of electrified hardware components. All modular power supplies are designed to meet UL 1481 Standards. Recommended for the SAF, SEC, M97, delayed egress exit devices and electric trim.

### Features

- Fire panel emergency release input
- PC Board mounted system LED indicator
- Regulated and filtered with input and output protection
- Battery charging is provided from a separate output terminal

### Electrical Specifications

- Inputs: 115VAC @600mA
- Outputs: 12/24 VDC @ 1 Amp, 1.5 Amp or 4 Amp, Filtered and regulated output

### Listings

- UL & cUL listed 1012 General Purpose Power Supply
- Fire & Burglar Alarm Power Supply Unit URT2
- Releasing device Accessory SYSW
- Access Control Systems Units ALVY
- Burglar Alarm Systems Power Supply APHY

### Applications

- D – Delayed Egress
- M97 – Electric Dogging
- SAF – Fail Safe mortise device trim control
- SEC – Fail Secure mortise device trim control

Note: Batteries are not included with the BPS power supply.

## 784 Power Supply

### Features

- Provides a filtered and regulated 9 VDC remote power
- Requires raceway through the door\*
- Optional 12 VDC gel cell battery. Provides continuous operation of in the event of a power failure. To order, specify 793F089.

### Includes:

- Plug-In Wall Transformer with approximately 12' (3.6m) of shielded wire that provides input power to the power supply
- Includes 12' (3.6m) of shielded wire for connection between power transfer and power supply
- To order separately, specify 793F039

\*Recommended for new opening. Retrofit application may require surface mounted wire mold and transfer loop by others.

Model	Enclosure	Input	Output
BPS-24-1	12" (304mm) x 9" (229mm) x 4" (102mm)	115VAC, 50/60 Hz.	1.0 Amp @ 24 VDC
BPS-24-2	14" (356mm) x 14" (356mm) x 4" (102mm)	115VAC, 50/60 Hz.	2.0 Amp @ 24 VDC
BPS-24-4	15" (381mm) x 18" (457mm) x 6" (152mm)	115VAC, 50/60 Hz.	4.0 Amp @ 24 VDC
BPS-12-1	12" (304mm) x 9" (229mm) x 4" (102mm)	115VAC, 50/60 Hz.	1 amp @ 12 VDC
BPS-12-3	14" (356mm) x 14" (356mm) x 4" (102mm)	115VAC, 50/60 Hz.	3 amp @ 12 VDC



BPS Power Supply



784 Power Supply

## Exit Controls and Switches

### Key Switches



MKA

MKA - (1) SPDT Maintained  
 MK - (1) SPDT Momentary  
 MKN - (1) SPDT Momentary NS  
 MK2 - (1) DPDT Momentary  
 MKPZ x MKS - (1) SPDT Momentary with audio Double Gang x Additional Switch  
 Note: All key switches come standard with 12/24 VDC bi-color LED.

### Specifications

- Keyswitch for operation using a standard 1-1/8" mortise cylinder (A02 cam) (cylinder not included).
- Contact Rating 5 Amps @ 12-24VDC
- SPDT 3-position.

### Push Buttons

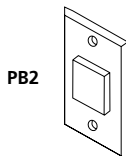

PB2

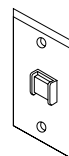

PB3

PB2 - (1) SPDT Momentary  
 PB2 - (1) DPST Remote Momentary  
 PB3 - (1) DPST Momentary  
 PB3A - (1) DPST Maintained (Alt. Action)  
 PB3EA - (1) DPST Alternate

### Specifications

- 3 Amps @ 12-24 VDC

### Audible/Visual Annunciators

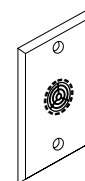

PZ1

PZ1 - Sonalert 90db @ 2ft. 12-24VDC. Mounted on one gang stainless steel plate.

### Digital Entry

DK-12 - Digital Keypad - 4 User  
 DK-26SS - Digital Keypad NS - 59 User - SS Finish  
 DK-26BK - Digital Keypad NS - 59 User - Black Finish

### Power Transfers

TSB B-C - Door Cord

# Electrified Applications

## ED4000

### Latch Pullback - M94 Option

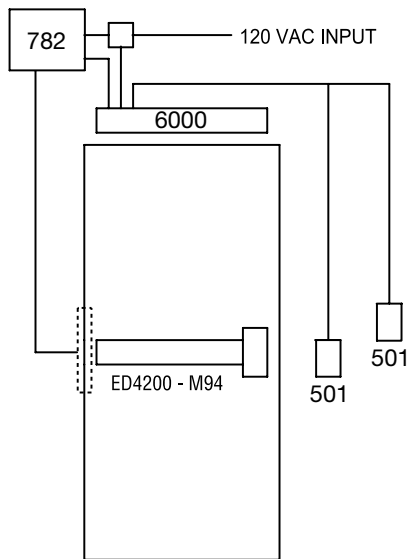

#### Components

ED4200 x M94 Latch Pullback Exit Device - Corbin Russwin  
782 Controller - Corbin Russwin  
6000 Operator - Norton  
501 Push Pad - Norton  
Power Transfer Hinge

#### Operation

Operation of Push Pads from either side of door will activate the 782 Controller for the Latch Pullback Exit Device. An internal timer on the 6000 will also provide length of time door is open and latch being retracted. Door operator also acts like standard closer when opened manually.

### Electric Dogging & Touchbar Monitoring Switch - M97 & M92

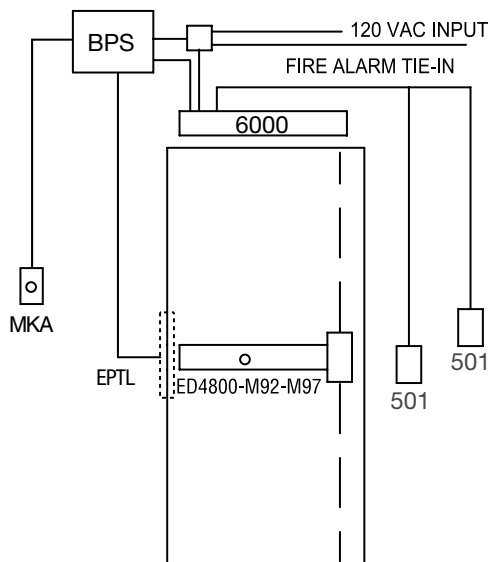

#### Components

ED4800 x M92 x M97 with Cyl. + Bar Monitor &  
Electric Dogging - Corbin Russwin  
6000 Operator - Norton  
501 Push Pad - Norton  
Power Transfer Hinge  
BPS Power Supply - Corbin Russwin  
Key Switch - Corbin Russwin

#### Operation

Operation of Electric Dogging combined with the Door Monitor Switch will enable Push Pads for operation of the 6000. A maintained keyswitch will control the activation of the electric dogging which is powered by the Power supply. A Fire Alarm Tie-In, if required, will release the dogging and let the operator work in manual mode when activated. (NOTE: Electric Dogging is not automatic like Latch Pullback. It requires the bar to be pushed in manually the first time after applying power.)

# Electrified Applications

ED4000

## Latch Pullback - M94 Option with Norton® 6000 Door Operator

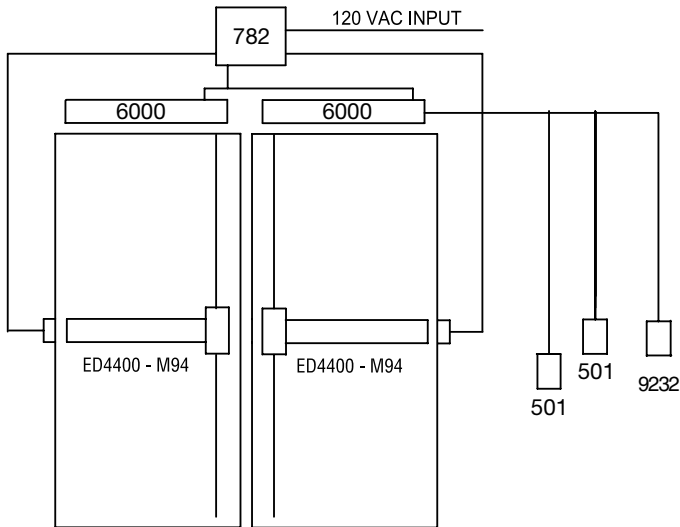

### Components

ED4400 x M94 Latch Pullback Exit Device – Corbin Russwin  
782 Controller – Corbin Russwin  
6000 Operator – Norton  
501 Push Pad – Norton  
Power Transfer Hinge  
Keyswitch – Corbin Russwin

### Operation

Activation and operation of Push Pads from either side of door will be controlled by the FAMKA Maintained Keyswitch. The Push Pads will in turn activate the 782 Controller for the Latch Pullback Exit Device. An internal timer on the 6000 will coordinate and prevent the door from being opened before latch retraction takes place. Standard timers on the 6000 will also provide length of time door is open and latch being retracted. Door operator also acts like standard closer when opened manually.

## Rim Device with Electric Strike

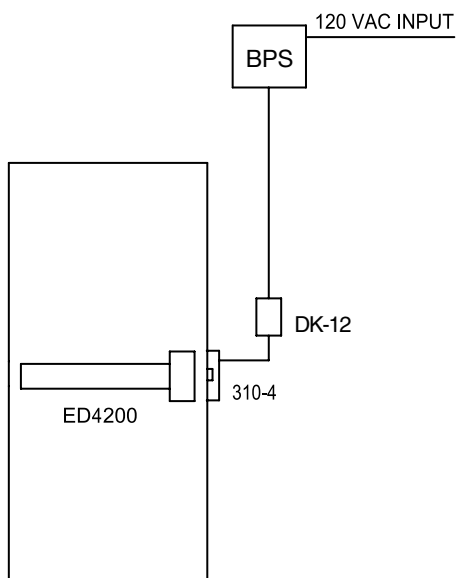

### Components

ED4200 Exit Device – Corbin Russwin  
DK-12 – Digital Keypad  
310-4 Electric Strike – Folger Adam®  
BPS Power Supply – Corbin Russwin

### Operation

Operation of DK-12 Digital Keypad will allow keyless entry from the non-protected side of opening. Free exit using the exit device from the protected side of the door.

# Electrified Applications

## ED4000

### Rim Exit Device with Delayed Egress Option on "Exit Only" Door

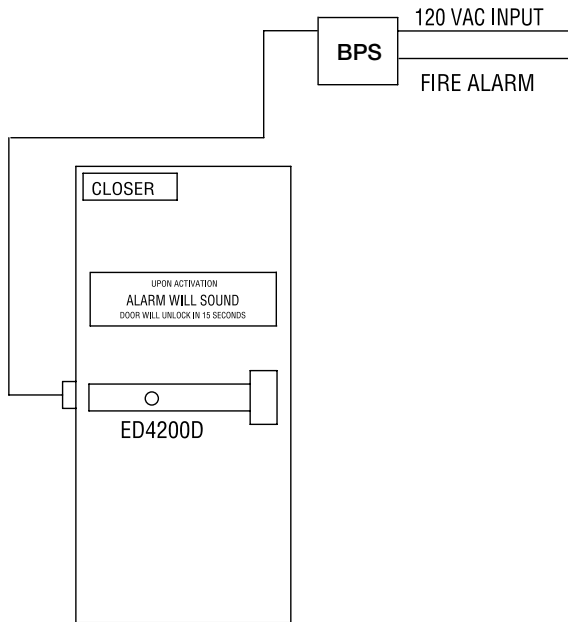

#### Components

ED4200D Delayed Egress Exit Device – Corbin Russwin  
Power Transfer Hinge  
BPS Power Supply – Corbin Russwin  
Surface Door Closer – Corbin Russwin

#### Operation

Operation of the ED4200D Exit Device will sound an alarm and activate either a 15- or 30-second alarm sequence inside of the exit device. After this time period, the device will release the pushbar, making it active, and egress is possible. When the fire alarm is activated, power to the exit device will be interrupted, allowing free egress and mechanical latching. Authorized alarm bypass and reset is done through the built-in keyswitch located in the exit device.

### Rim Exit Device - High Security Application M91, M92 and M93 Monitoring Switch Options With FAMSS-1C Door Position Switch

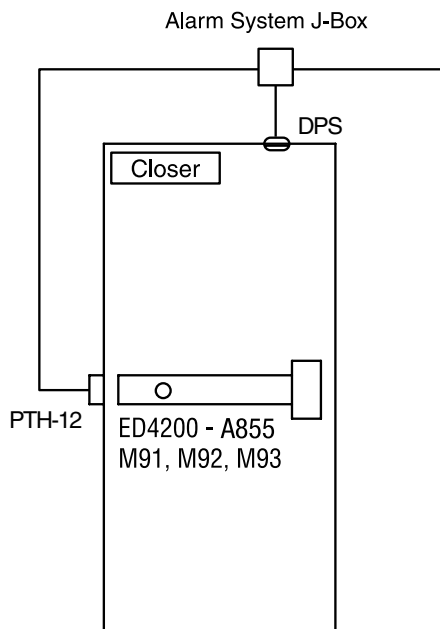

#### Components

ED4200 - A855 Nightlatch Trim – Corbin Russwin  
M91 Bolt Monitor Switch  
M92 Touchbar Monitor Switch  
M93 Trim Monitor Switch

Door Position Switch  
Power Transfer Hinge  
Surface Door Closer – Corbin Russwin

#### Operation

Operation of the ED4200 Exit Device with the M91, M92, M93 and a door position switch can be used together or individually to sound an alarm, shunt an alarm, monitor the door's security or as a "Request to Exit" in conjunction with a magnetic lock.

# Mullions

## ED4000

### 808 Mullion

Used to install two Rim Exit Devices in a double door opening. May be quickly and easily removed when a full double door opening is temporarily required.

### Materials and Finish

Extruded aluminum mullion, 1-1/4" x 3-1/2" x 8'2" (for 8'0" doors), supplied with two integral strikes, top and bottom mounting brackets, two sets of mullion stabilizers, and zinc-plated fasteners for metal frames and concrete floors. May be cut, drilled and tapped in the field for Rim Exit Devices. Available in 628 and 695 finishes.

### Ordering

To order, specify Part No. 808 x Finish.

### Mullion Stabilizer Kit

Controls the movement of the mullion. Recommended for openings over 7' high or whenever door movement must be minimized. Available in 628 and 695 finishes. Two sets supplied standard with all 808 mullions. To order separately, specify Part No. 653F11-1 x Finish.

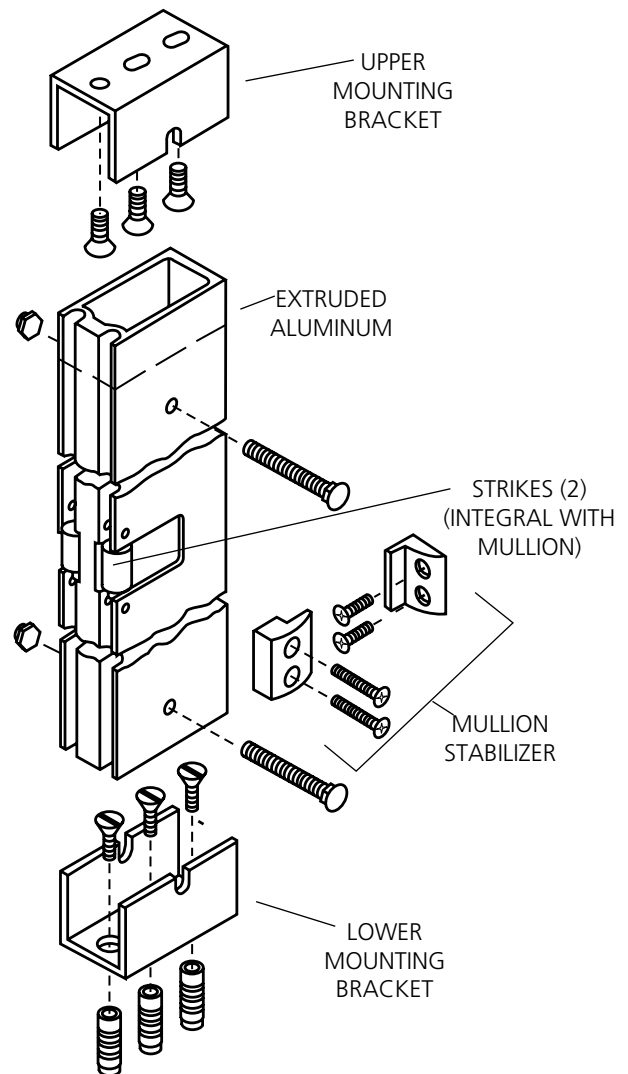

# Options and Accessories

## ED4000

### Shim Kits

Designed for mounting an exit device over raised vision light molding. Each kit contains two sets of 1/8" thick shims to shim a device 1/8" (3mm) or 1/4" (6mm). Black finish. To order with exit device, specify M58. To order separately, specify Part No.

Exit Device Type	Shim Kit Part No.
ED4200, ED4200S, ED4800	697F35-8
ED4400	697F36-8

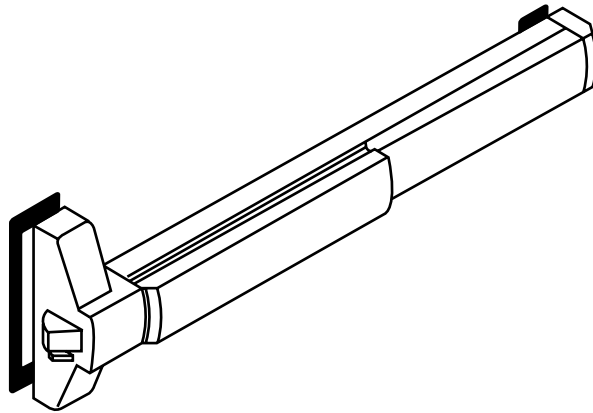

### Cylinder Dogging Kits

Designed to convert a panic device from hex key dogging to cylinder dogging. To order cylinder dogging kit, specify Part No. x Finish below. Cylinder not included.

Bar Length	Cylinder Dogging Kit Part No.
36" (914mm)	653F13 x Finish
48" (1219mm)	653F14 x Finish

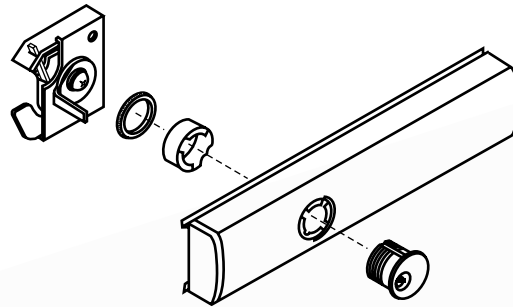

### ED5000DB Inactive Bar

Non-operating dummy pushbar available for doors up to 48" wide. May be field cut for narrower doors. To order, specify ED5000DB x Finish.

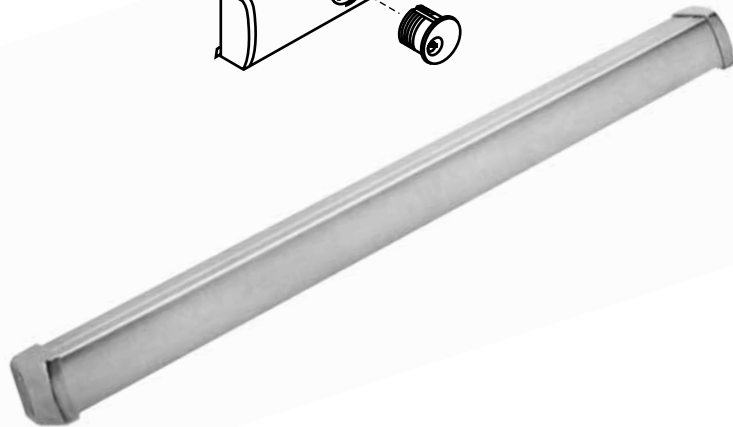





### Surface and Concealed Vertical Rod Extension Kits

Used to extend the height of standard length rods supplied with ED4400 and ED4800 Series exit devices. Available in 2", 6" and 12" sizes. To order with exit device, see How to Order, page 31. To order separately, specify Part No. x Finish.

Rod Extension	Rod Extension Kit Part No.
2" (50mm)	653F13 x Finish
6" (152mm)	653F14 x Finish
12" (305mm)	655F17 x Finish

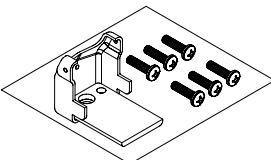
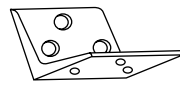
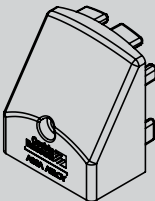
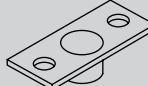
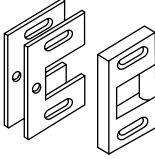
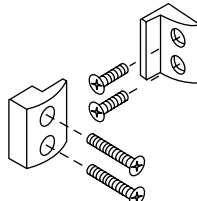
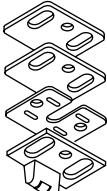
# Options and Accessories

## ED4000

<p><b>Rim Strike</b> (Screws Included)</p> 		<p><b>End Cap Reinforcement**</b> A solid steel plate, welded to the end bracket, evenly distributes impact forces over a larger surface area, eliminating point loading. To order with an exit device, specify M109. To order separately specify 705F09 x finish.</p>		<p><b>Flush Transom Top Strike Bracket</b> Optional for use with ED4400 devices. Used to mount top strike on openings with flush transom. 2-1/2" x 1-5/8" (64mm x 41mm). Black finish only. To order with exit device, specify M67. To order separately, specify 650F87-8.</p>
	<p><b>Flush End Cap</b> Durable heavy-duty cast steel or stainless steel, sits flush on the exit device rail and has a low profile which eliminates catch points. To order with a device, specify M110. To order separately specify 710F00M x finish.</p>		<p><b>Bottom Strike for 1/2" Thresholds</b> Optional for use with ED4400 and ED4800 devices. Required for 1/2" (13mm) threshold or for flush mount. 2-5/8" x 1-1/16" (67mm x 27mm). Black finish only. To order with exit device, specify S09. To order separately, specify 650F88-8.</p>	
	<p><b>Rim Strike</b> Standard on ED4200 and ED4200S devices, Supplied with two 1/16" (2mm) shims. For doors with 1/2" (13mm) or 5/8" (16mm) stop. Adjustable to compensate for shrinkage and swelling of door. 3" x 2" (76mm x 51mm). Black finish only. To order separately, specify 650F31-8.</p>		<p><b>Mullion Stabilizer Kit</b> Controls the movement of the mullion. Two sets supplied standard with all 808 mullions. Available in 628 and 695 finishes. To order separately, specify Part No. 653F11-1 x Finish.</p>	
<p><b>Surface and Concealed Vertical Rod Strikes</b> (Screws Included)</p>		<p><b>Filler Plates</b></p>		
	<p><b>Top Strike</b> Standard on ED4400 and ED4800 devices. Supplied with two 1/16" (2mm) shims and one 1/16" (2mm) locking plate. Adjustable to compensate for shrinkage and swelling of door. 1-9/16" x 15/16" (40mm x 24mm). Black finish only. To order separately, specify 650F548.</p>		<p>Optional for use on stock metal doors when required. To order, specify Part No. x Finish.  Front: 334F99-8 600</p>	
	<p><b>Bottom Strike</b> Standard on ED4400 and ED4800 devices. 1-1/16" (27mm) diameter x 1/16" (2mm) lip x 11/16" (17mm) high. Black finish only.  Both top and bottom strikes are included in the vertical rod parts packet. To order parts packet, specify 650F57-8.</p>		<p>Optional for use on stock metal doors when required. To order, specify Part No. x Finish.  Strike: 236L708018 x Fin</p>	
			<p>Optional for use on stock metal doors when required. To order, specify Part No. x Finish.  Front: 077F19-8 600</p>	

### Photoluminescent Touchpad Cover

The PathLite™ patent pending technology offers a number of benefits:

- Requires no wiring or maintenance
- Recharges with exposure to ambient light
- Unaffected by heat or cold
- Non-toxic, will not rub or fade
- Vandal resistant

\*\*Note: Six 1/4 x 20 screws come standard with either M109 option or 705F09 kit. Only two screws required to fasten end cap assembly to door for retrofit. Other four screws are used with SecureBolt® Latch Head if ordered as an M109 option with complete device. When the kit is ordered a new end cap is also supplied.

# Cylinders

## ED4000

### Rim (Trim Only)

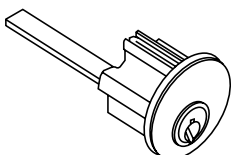

Description	Part Number	Cylinder Ring	Part Number	Cylinder Ring** 57 Function Only
6-pin	3000-058	270F15	3000-200N*	270F15
7-pin	3000-058-7	654F07	3000-200-7	654F07
6-pin, IC	3080-058	654F07	3080-178	654F07
7-pin, IC	3080-058-7	654F08	3080-178-7	654F08
6-pin, IC, less core	3070-058	654F07	3070-178	654F07
7-pin, IC, less core	3070-058-7	654F08	3070-178-7	654F08
6-pin, Security	3010-058	654F07	3010-200	654F07
6-pin, Security IC	3090-058	654F07	3090-178	654F07
7-pin, Pyramid	3020-058	654F07	3020-200	654F07
7-pin, Pyramid IC	3030-058	654F07	3030-178	654F07

\*For K157, substitute -200

\*\*K157 uses the 270F15 cylinder ring

### Mortise (Cylinder Dogging Only)

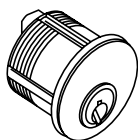

Description	Part Number	Cylinder Ring
6-pin	1000-118-A02	N/A
7-pin	1000-114-A02-7	270F15
6-pin, IC	1080-114-A02	270F15
7-pin, IC	1080-112-A02-7	654F07
6-pin, IC, less core	1070-114-A02	270F15
7-pin, IC, less core	1070-112-A02-7	654F07
6-pin, Security	1010-118-A02	270F15
6-pin, Security IC	1090-114-A02	270F15
7-pin, Pyramid	1020-114-A02	270F15
7-pin, Pyramid IC	1030-114-A02	270F15



# How to Order

## ED4000

### Ordering Examples

#### Exit Device Only

Quantity	Series/ Function	Finish	Hand	Misc. Options
24	ED4200S	626	RHR	M51-M54

#### Removable Mullion

Quantity	Mullion	Finish
12	808	695

#### Exit Device with Trim

Quantity	Exit Device	Trim/ Function	Finish	Hand	Door Thickness	Door Width	Door Height	Misc. Options
36	ED4400	N855	605	LHR	D200	W048	H0706	M51-M54

#### Trim Only

Quantity	Trim/ Function	Finish	Hand	Door Thickness	Cylinder Option
24	N855	625	RHR	D214	6P

#### Contract/Detailed Order – Exit Device with Trim

Quantity	Keyset	Exit Device	Trim/ Function	Finish	Hand	Door Height	Optional Strike	Door Width	Misc. Options	Cylinder Option
36	AA1	ED4400	C855	626	LHR	H0800	S09	W048	M52-M54	7P

### Where to find ordering information and Quick Codes

Trims and Functions	Page 14
Removable Mullion	Page 27
Handing	Page 32
Door Thickness	Page 32
Strike	Page 32
Door Width	Page 32
Door Height	Page 32
Miscellaneous Options	Page 32
Cylinder and Keying	Page 32



# Quick Codes

## ED4000

### Cylinder and Keying

Description	Specify
Less cylinder(s)	(standard)
Conventional 6-pin	6P
Conventional 7-pin	7P
Security	HS
Security interchangeable core (IC)	CHS
IC 6-pin	C6
IC 6-pin with temporary construction core (Red)	CT6R
IC 6-pin with temporary construction core (Blue)	CT6B
IC 6-pin with temporary construction core (Green)	CT6G
IC 6-pin with temporary construction core	CT6
IC 6-Pin with temporary disposable core	CT6D
IC 6-pin less core	CL6
SFIC 6-pin with less core	CLS6
SFIC 6-pin with SFIC disposable temporary core	CT6SD
IC 7-pin (rim only)	C7
IC 7-pin with temporary construction core (Red)	CT7R
IC 7-pin with temporary construction core (Blue)	CT7B
IC 7-pin with temporary construction core (Green)	CT7G
IC 7-pin with temporary construction core	CT7
IC 7-Pin with temporary disposable core	CT7D
IC 7-pin less core (rim only)	CL7
SFIC 7-pin with less core	CLS7
SFIC 7-pin with SFIC disposable temporary core <sub>3</sub>	CT7SD
Pyramid Security fixed core	PS
Pyramid Security IC	PCS
Pyramid Fixed Core	PHS
Pyramid IC	PCHS
Pyramid with temporary construction core	CTP
Pyramid less core	CLP
Blockout function	BO
0-bitted with 2 blank keys	(standard)
Keyed random	KR
Construction master keyed	CMK

### Finish

Description	Specify
US3 Bright Brass	605
US4 Satin Brass	606
US9 Bright Bronze	611
US10 Satin Bronze	612
US10B Dark Oxidized Satin Bronze, oil rubbed	613
US10BE Dark Oxidized Satin Bronze Equivalent	613E
US14 Bright Nickel Plated	618
US15 Satin Nickel Plated	619
US26 Bright Chromium Plated	625
US26D Satin Chromium Plated	626* (Trim only)
Satin Chromium Plated with MicroShield®	 626C
US32 Bright Stainless Steel	629
US32D Stain Stainless Steel	630
Stain Stainless Steel with MicroShield®	 630C
Satin Aluminum, Clear Anodized (mullions only)	628
Dark Bronze Coated (mullions only)	695
— Black oxidized bronze, oil rubbed	722

\*Contact factory for devices required in BHMA 626

### Door Height

Door Height	Specify
ED4400 devices	
7'0"	(standard)
7'2"	H0702
7'6"	H0706
8'0"	H0800
9'0"	H0900
10'0"	H1000
ED4800 devices	
8'0"	(standard)
8'2"	H0802
8'6"	H0806
9'0"	H0900
10'0"	H1000

# Quick Codes

## ED4000

### Door Width

Door Width	Specify
24" (610mm)	W024
36" (914mm)	(standard)
48" (1219mm)	W048

### Handing

Hand	Specify
Right Hand Reverse	RHR
Left Hand Reverse	LHR

### Door Thickness

Door	Specify
1-3/4" (44mm)	(standard)
2" (51mm)	D200
2-1/4" (57mm)	D214

### Strike

Description	Specify
Surface and concealed vertical rod Bottom strike for 1/2" thresholds	S09

### Removable Mullion

Door Height	Specify
Up to 8'0" (ED4200 & ED4200S)	808

### Miscellaneous Options

Description	Specify
Torx® head screws	M04
Knurling outside and inside (embossed touchbar - device side)	M20
Knurling outside only (trim side)	M21
Knurling inside only (embossed touchbar - device side)	M22
Abrasive coat outside and inside (trim and device)	M23
Abrasive coat inside only (device side)	M24
Abrasive coat outside only (trim side)	M25
24", 36" and 48" PathLite™ Photoluminescent Touchbar Cover	M49
Less dogging	M51
Cylinder dogging	M52
Sex nuts and bolts (SNBs)	M54
Shim kit (for vision light)	M58
Flush transom top strike bracket (ED5400 and ED5400A only)	M67
High Impact End Clamp	M109
Flush End Cap	M110

### Electrical Options

Description	Specify
Alarm Option	M61
Bolt Position Monitor	M91
Touchbar Monitor	M92
Trim Monitor	M93
Latch Pullback	M94
Electric Dogging	M97
Delayed Egress	D

# Facts and Figures

## ED4000

### ED4000 Series (all variables)

Series	"A"	"B"
ED4000	34-5/8" (880mm)	18" (457mm)
ED4000 x W024	22-5/8" (575mm)	12" (305mm)
ED4000 x W048	46-5/8" (1184mm)	24" (610mm)

Dimensions are shown in: **inches**  
**mm**

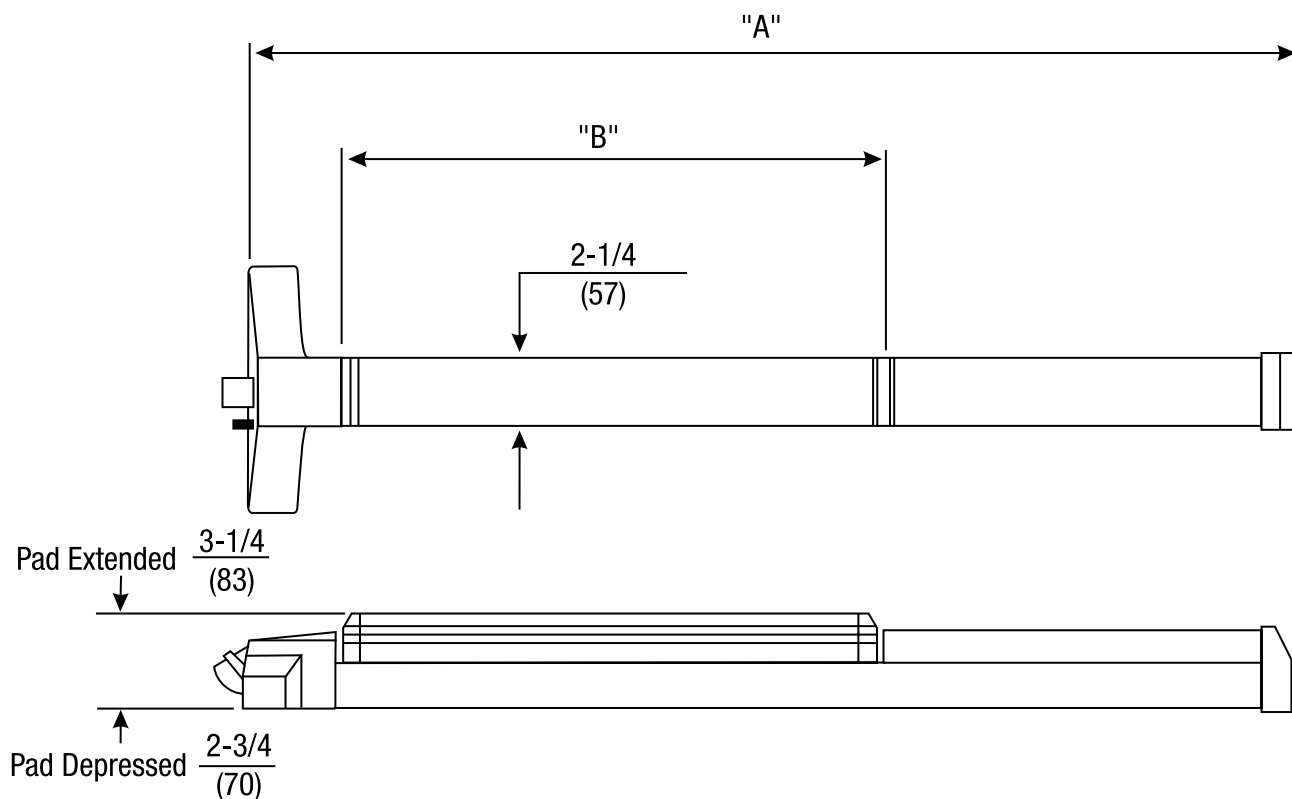
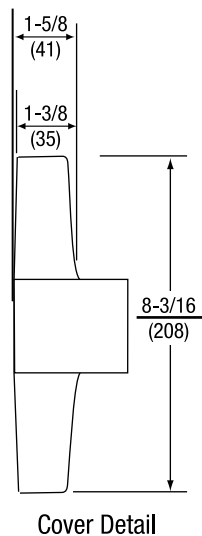

# Helpful Terms

ED4000

## **Abrasive Coat**

Hard granular material applied to provide a non-slip tactile surface for the visually impaired.

## **Active Door**

In a pair of doors, the door that is operable from the trim side.

## **Astragal**

A vertical member applied to one or both sides of a pair of doors at the meeting edges. The astragal closes the gap between the two doors.

## **Coordinator**

A device used on a pair of doors to ensure that the inactive door closes before the active door.

## **Deadlocking Latch**

A supplemental latch that automatically deadlocks the latchbolt when pressure is applied to it.

## **Dogging**

A mechanism that allows the latchbolt to remain retracted, permitting the door to operate as if it were a push-pull; it cannot be used on fire-rated exit devices.

## **Double Egress**

A pair of doors of the same hand that swing in opposite directions, commonly found in corridors.

## **Dummy Trim**

Trim only. Usually used on the inactive door of a pair of doors for design balance.

## **Exit Device (Panic Hardware)**

A door locking device with a pushbar or crossbar which, when pressed, allows instant exit (egress).

## **Fire Exit Hardware**

An exit device listed by an independent testing laboratory as meeting panic, fire and hose stream test standards; used on fire-rated openings.

## **Hand**

The direction a door swings.

## **Inactive Door**

In a pair of doors, the door that is inoperable from the trim side.

## **Latchbolt**

A lock component that has a beveled end and projects into a strike, holding the door in a closed position.

## **Mullion**

A fixed or removable vertical member that divides a door opening and provides a latch surface for a pair of rim exit devices.

## **Open Back Strike**

For mortise exit devices, used on the inactive door (usually the vertical rod door) of a pair of doors that swing in the same direction. It permits the inactive door to open or close independently.

## **Reversible**

Pertains to a product that may be changed in the field to accommodate any hand of the door.

## **Shim Kit**

Pieces of metal that permit mounting of an exit device on a door that has a surface projecting vision light (glass bead) molding.

## **Split Astragal**

An astragal that is split through the middle on a pair of doors, allowing both doors to operate independently.

## **Threshold**

A strip fastened to the floor beneath a door. It serves as a stop, prevents heat loss, and provides a strike location for latching the bottom rod of a vertical rod exit device.

## **Trim**

A knob, lever, pull, or thumbpiece used on the outside of an exit device door to control access to an area.

## **Universal Exit Device**

An exit device that may be used on doors of either hand without any modifications.

## **Keying and Cylinder Terms**

### **Blockout Cylinder**

A cylinder which allows all keys to be temporarily blocked from operating. It is set by a blockout key.

### **Concealed Key Control (CKC)**

The marking of standard key symbols on a cylinder in a location that is not visible once the cylinder is installed.

### **Construction Master Keying (CMK)**

A cylinder preparation that allows temporary access by construction personnel.

### **Control key**

A key used to remove and install interchangeable cores.

### **Cylinder**

A lock component containing the combination that determines which keys will operate.

### **Security Cylinder**

A cylinder which provides extra resistance to picking and unauthorized duplication of keys.

### **Interchangeable Core (IC)**

A cylinder which can be removed and installed quickly with a control key by non-skilled personnel when rekeying is required.

### **Key Symbol**

A letter/number combination in standard industry format (e.g., 1AA, AA1, etc.) which indicates exactly how a key or cylinder fits into a keying system.

### **Keyway**

The opening in a cylinder plug through which the key enters.

### **Master Keying**

Preparation of a cylinder to operate with keys of different levels of access.

### **Visual Key Control (VKC)**

The marking of standard key symbols on keys and on the visible portion of the front of a cylinder.

# Suggested Specification

## ED4000

### Suggested Specification

Exit devices shall be ED4000 Series Narrow Stile Pushpad Exit Devices.

The exit device chassis shall be cold forged steel, electroplated for corrosion resistance, and shall be architecturally finished brass, bronze or stainless steel. The pushpad mechanism shall be constructed of extruded aluminum and shall be scalped with architecturally finished brass, bronze or stainless steel. The maximum projection shall be 3-1/4" when the pushpad is active and 2-3/4" when the pushpad is dogged down. Nylon bearings and stainless steel springs shall be used for long life and durability; only torsion springs are acceptable. Rear and active case covers shall be wrought brass or bronze and shall be plated to match the exit bar. Plastic or painted covers are not acceptable. Latchbolts shall be steel and shall incorporate a deadlocking latch feature for increased security. Devices without deadlocking latches are not acceptable. Mounting screws shall be concealed to deter tampering. Devices shall be closed on all sides with no pinch points. All exit devices shall be easily field sized to accommodate various door widths.

Exit devices shall have single point, one quarter turn hex key dogging standard. Optional cylinder dogging shall be available. Devices with hex key dogging shall be easily field converted to cylinder dogging. Panic listed devices shall be available less dogging. Trims shall be throughbolted with concealed fasteners. Escutcheon and pull type trims shall be constructed of brass or bronze. All lever trims shall use cast or forged levers. On trims with cylinders, the mechanism that locks and unlocks the trim shall be housed in the trim and not in the active case of the exit device. Lever trims shall match those on Corbin Russwin Mortise and Cylindrical Locksets.

Exit devices and trims shall be furnished in BHMA standard architectural finishes.

Exit devices shall be listed by Underwriters Laboratories (UL) for safety as panic hardware.

Certification:  
ANSI/BHMA A156.3, Grade 1

Exit devices, trims and cylinders shall be from one manufacturer.

Trims and electronic components shall carry a two-year limited warranty.

Exit devices shall carry a five-year limited warranty.

# Notes

ED4000



**ASSA ABLOY**

**In U.S.**

Corbin Russwin  
Architectural Hardware  
225 Episcopal Road  
Berlin, CT 06037  
Phone: 800-543-3658  
Fax: 800-447-6714  
corbinrusswin.com

**In Canada**

ASSA ABLOY Door  
Security Solutions Canada  
160 Four Valley Drive  
Vaughan, Ontario  
Canada L4K 4T9  
Phone: 800-461-3007  
Fax: 905-738-2478  
www.assaabloy.ca

For more information regarding Corbin Russwin Locksets, Exit Devices, Door Controls and Key Systems, contact your authorized Corbin Russwin Distributor or Sales Representative.



**MicroShield®**

As part of their promise to provide innovative solutions to their customers, ASSA ABLOY Group companies offer the MicroShield® technology, a silver-based antimicrobial coating designed to stem the spread of germs and bacteria. MicroShield® is a registered trademark of Yale Security Inc., an ASSA ABLOY Group company.

Corbin Russwin and Design® and SecureBolt® are registered trademarks of Corbin Russwin, Inc., an ASSA ABLOY Group company. Norton® is a registered trademark of Yale Security Inc., an ASSA ABLOY Group company. Other products' brand names may be trademarks or registered trademarks of their respective owners and are mentioned for reference purposes only. These materials are protected under US copyright laws. All contents current at time of publication. Corbin Russwin, Inc., an ASSA ABLOY Group company reserves the right to change availability of any item in this catalog, its design, construction, and/or its materials. Copyright © 2001, 2014 Corbin Russwin, Inc., an ASSA ABLOY Group company. All rights reserved. Reproduction in whole or in part without the express written permission of Corbin Russwin, Inc. is prohibited.

ASSA ABLOY is the global leader in door opening solutions, dedicated to satisfying end-user needs for security, safety and convenience