

# Architectural Door Accessories

**ASSA ABLOY**

The global leader in  
door opening solutions

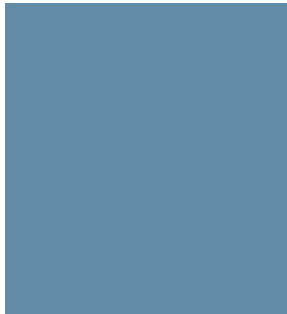
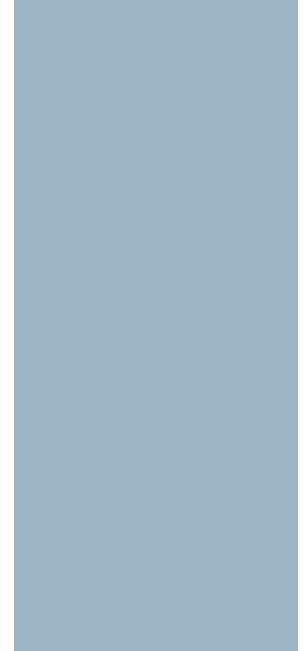
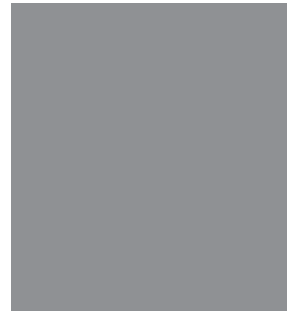
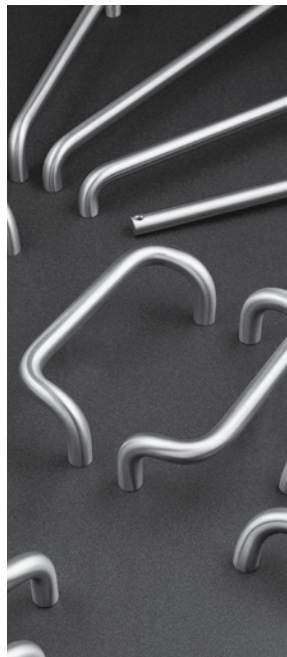
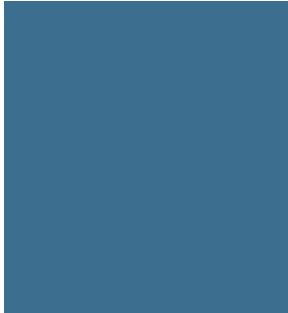
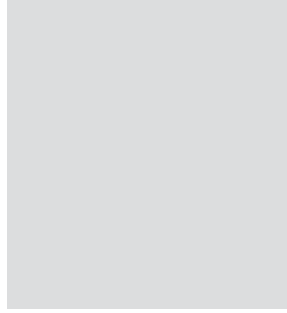

**Rockwood Products  
Condensed Catalog**

## Introduction

Rockwood Manufacturing Company, founded in 1946 by the Gurzenda Family in rural southwestern Pennsylvania, focuses on the design and manufacture of quality builders hardware for commercial, institutional and finer residential buildings. In 2008, Rockwood Manufacturing Company joined the ASSA ABLOY family. Now in our third generation of skilled craftsman in Rockwood, PA we continue to develop new products and processes that improve our offering. Strict attention to detail from the selection of top-grade materials to the application of the finest finishes results in a tough, yet handsome product of the highest caliber.

The items shown in this catalog are only a representative selection of our line. We have standard items for hospitals, schools, and other institutions. We also have a wide selection of hardware including door stops, coat hooks, signs and filler plates. Please see our representative in your area or visit our web site at [www.rockwoodmfg.com](http://www.rockwoodmfg.com) to view our Accessories and Architectural Catalogs.

## Custom Designs

Design your own hardware! Whether it is a modification of a standard product or a completely unique design, our customer service team will quote your requirements and offer suggestions for best mounting applications. We take special pride in our custom products. Visit the Custom Pull Library at [www.rockwoodmfg.com](http://www.rockwoodmfg.com) to view a sampling of custom pulls we have created. We work with you to create that show stopping, one of a kind design that greets everyone who opens your door.



## Special Architectural Finishes

US32316 and US32D316 — Alloy 316 stainless steel for superior corrosion resistance.

WPC, BPC, RPC — Powder coat color finishes (white, black, red). Other powder coat colors available upon request.

US10BE - Powder coat oxidized equivalent of 10B

US32DMS — use MicroShield antimicrobial coating to help prevent bacterial growth and to help attain LEED credit for Mold Prevention.



### MicroShield®

As part of their promise to provide innovative solutions to their customers, certain ASSA ABLOY Group brands offer the MicroShield® technology, a silver-based antimicrobial coating designed to inhibit the growth of bacteria.

MicroShield® is a registered trademark of Yale Security Inc., an ASSA ABLOY Group company.

# ASSA ABLOY

The global leader in  
door opening solutions

800-458-2424 | [www.rockwoodmfg.com](http://www.rockwoodmfg.com)  
Check the web site for the up-to-date catalog

Copyright © 2013-2017, Rockwood Manufacturing Company, an ASSA ABLOY Group company. All rights reserved.  
Reproduction in whole or in part without the express written permission of Rockwood Manufacturing Company is prohibited.

## Push Plates

Produced from the largest available selection of base metals and finishes. A complete listing may be found in our Full Line Catalog. The push plates are a standard .050" thick; other thicknesses are available upon request. They meet ANSI 156.6 standards. Plates can be mated with most door pulls.



70-73

### .050" Thick Material

No.	Size
70A	3" x 12"
70B	3½" x 15"
70C- RKW	4" x 16"
70E	6" x 16"
70F	8" x 16"

### .125" Thick Material

No.	Size
73A	3" x 12"
73B	3½" x 15"
73C	4" x 16"
73E	6" x 16"
73F	8" x 16"



76

77

### Decorative Push Plates

No.	Size
76B	3½" x 15"
76C	4" x 16"
77B	3½" x 15"
77C	4" x 16"

## Flush Pulls

These flush pulls are available in most architectural finishes. All face plates are fabricated from 1/8" thick material providing a solid appearance and structure. Tamperproof torx or security socket machine screws can be furnished for high security installations. The 94C, 95A, 95B, and 95R are concealed mounted by screws in the side wall of the recess cup area.



94

BF97

91-RKW

94C

BF97L



95R



95A



95B

No.	Size	Grip Opening
91- RKW	3½" x 15¾"	–
94	3½" x 5"	1¾" x 3⅛"
94C	3½" x 5"	1¾" x 3⅛"
95A	2³⁄₁₆" x 3¹⁄₄"	7⁄₈" x 2⁷⁄₁₆"
95B	2¹¹⁄₁₆" x 4³⁄₁₆"	1⁷⁄₁₆" x 3½"
95R	3½" dia.	2³⁄₄" x 1¹¹⁄₁₆"
BF97	5" x 5"	2½" x 3½"
BF97L	5" x 5"	2½" x 3½"

800-458-2424 | [www.rockwoodmfg.com](http://www.rockwoodmfg.com)

Check the web site for the up-to-date catalog

Copyright © 2013-2017, Rockwood Manufacturing Company, an ASSA ABLOY Group company. All rights reserved. Reproduction in whole or in part without the express written permission of Rockwood Manufacturing Company is prohibited.

# ASSA ABLOY

The global leader in  
door opening solutions

# Pulls

## DOOR PULLS

These sturdy pulls will enhance the look of any door. They may be thru bolt singly, or mounted in pairs back to back. They are manufactured from 1" diameter solid bar stock. Because they are fabricated in our own factory, a variety of modifications may easily be made. These door pulls are available in standard and special architectural finishes, and conform to ANSI 156.6 standards.



110-RKW

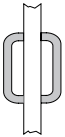

back to back

### Straight

No.	CTC
110- RKW	8"
111	10"
112	12"
110BTB	8"
111BTB	10"
112BTB	12"

BF prefix = Barrier Free  
BTB suffix = Set of 2 Back To Back



BF156

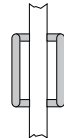

back to back

### Offset

No.	CTC
BF156	8"
BF157A	9"
BF157	10"
BF158	12"
BF156BTB	8"
BF157ABTB	9"
BF157BTB	10"
BF158BTB	12"

## PULL PLATES

Featured are just a few of our most popular pull plates and are available in all architectural finishes. They are .050" thick and meet ANSI 156.6 standards.



107x70C



122x70C

No.	Pull CTC	Pull Size
102x70B	5 1/2"	5/8" Diameter
102x70C	5 1/2"	5/8" Diameter
105x70B	5 1/2"	3/4" Diameter
105x70C	5 1/2"	3/4" Diameter
106x70B	6"	3/4" Diameter
106x70C	6"	3/4" Diameter
107x70B	8"	3/4" Diameter
107x70C	8"	3/4" Diameter
122x70B	6"	3/8" x 1 1/4"
122x70C	6"	3/8" x 1 1/4"
125x70B	6"	1" half round
125x70C	6"	1" half round

## DECORATIVE PULL PLATES

These pull plates are .050" thick wrought, stocked in standard architectural finishes, and meet ANSI 156.6 standards.



147x76B



148x77B

No.	Pull CTC	Plate Size
147 x 76B	6"	3 1/2" x 15"
147 x 76C	6"	4" x 16"
147 x 77B	6"	3 1/2" x 15"
147 x 77C	6"	4" x 16"
148 x 76B	8"	3 1/2" x 15"
148 x 76C	8"	4" x 16"
148 x 77B	8"	3 1/2" x 15"
148 x 77C	8"	4" x 16"

# ASSA ABLOY

The global leader in door opening solutions

800-458-2424 | [www.rockwoodmfg.com](http://www.rockwoodmfg.com)  
Check the web site for the up-to-date catalog

Copyright © 2013-2017, Rockwood Manufacturing Company, an ASSA ABLOY Group company. All rights reserved. Reproduction in whole or in part without the express written permission of Rockwood Manufacturing Company is prohibited.

## Pulls

### HEAVY DUTY OFFSET DOOR PULLS

These solid 1<sup>1</sup>/<sub>4</sub>" diameter heavy duty pulls are designed for mounting on rough surface areas. The large footprint on door provides stable mounting. Pulls are available in all architectural finishes and conform to ANSI 156.6 standards.

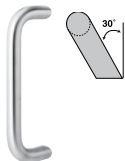

BF258

No.	CTC	No.	CTC
BF257	10"	BF259	18"
BF258	12"	BF260	24"

### SECURITY LOOP DOOR PULL

Choose from brass or stainless steel material. Available in US4, US10BE, US32D, and US32DMS finishes and conform to ANSI 156.6 standards. Supplied with security torx screws.



D133-RKW

No.	CTC
D133- RKW	7 <sup>3</sup> / <sub>4</sub> "

### HEAVY DUTY SECURITY FLUSH PULL

The #D89 is made from cast brass material. Available in US4, US10BE and US26D finishes and conform to ANSI 156.6 standards. Supplied with security torx screws.



D89

No.	Size
D89	4" x 5"

### VANDAL RESISTANT TRIM

Heavy duty stainless steel construction, thru bolt mounted, and has a tamper resistant design. The VRT24 and VRT26 feature a soft black textured grip. US Patent No. D659,507S. VRP30 has patent pending and offered in powder coat finishes.



VRT14



VRT16



VRT24



VRT26



VRP30

No.	Width x Height
VRT14	6 <sup>3</sup> / <sub>4</sub> " x 12"
VRT16	5 <sup>3</sup> / <sub>8</sub> " X 12"
VRT24	6 <sup>3</sup> / <sub>4</sub> " x 12"
VRT26	5 <sup>3</sup> / <sub>8</sub> " X 12"
VRP30	4" x 16"

800-458-2424 | [www.rockwoodmfg.com](http://www.rockwoodmfg.com)

Check the web site for the up-to-date catalog

Copyright © 2013-2017, Rockwood Manufacturing Company, an ASSA ABLOY Group company. All rights reserved. Reproduction in whole or in part without the express written permission of Rockwood Manufacturing Company is prohibited.

## ASSA ABLOY

The global leader in  
door opening solutions

## Locking Door Pulls

The Locking Pull System integrates our contemporary PostMount or GeoMetek style door pull with a deadbolt locking system. Engineered for ease of installation, the locking pull is manufactured to ensure strength and durability with clean and appealing lines. Leather and GripZone options create a variety of styles to choose from. The addition of a push bar to your locking door pull reduces finger prints on glass doors.



LP3301

### PostMount-Round

No.	Description
LP3301DBD	Half Height Pull - Bolts Down
LP3301DBU	Half Height Pull - Bolts Up
LP3301FHD	Full Height Pull - Bolts Down
LP3301FHU	Full Height Pull - Bolts Up
LP3301FHB	Full Height Pull - Bolts Up and Down



LP7901

### GeoMetek-Square

No.	Description
LP7901DBD	Half Height Pull - Bolts Down
LP7901DBU	Half Height Pull - Bolts Up
LP7901FHD	Full Height Pull - Bolts Down
LP7901FHU	Full Height Pull - Bolts Up
LP7901FHB	Full Height Pull - Bolts Up and Down

## ARCHITECTURAL DOOR PULLS

Rockwood architectural door pulls are custom made to the center-to-center dimension required to fit your door. Shown below is a small section of our many door pulls.



RM3300

### MegaTek Straight Pulls

No.	Dia.	OA
RM3300	1"	Specify up to 144"
RM3301	1 1/4"	Specify up to 144"
RM3302	1 1/2"	Specify up to 144"

\*RM3301 is offered in Quick Ship

Select sizes available. Only in Back to Back Mounting for 1 3/4" wood/metal or 1/2" glass doors



RM3310

### MegaTek Offset Pulls

No.	Dia.	OA
RM3310	1"	Specify up to 144"
RM3311	1 1/4"	Specify up to 144"
RM3312	1 1/2"	Specify up to 144"



RM7900

### GeoMetek Flat End Pulls

No.	Grip Size	OA
RM7900	3/4" x 3/4"	Up to 120"
RM7910	3/4" x 1 1/2"	Up to 120"
RM7940	1 1/4" x 1 1/4"	Up to 120"



RM7902

### GeoMetek Flat Bridge Pulls

No.	Grip Size	OA
RM7902	3/4" x 3/4"	Up to 120"
RM7912	3/4" x 1 1/2"	Up to 120"

### the good design studio

The Good Design Studio - your resource for beautiful doors, frames and hardware from ASSA ABLOY Group brands. Visit [www.thegooddesignstudio.com](http://www.thegooddesignstudio.com) to learn more.



Corbin Russwin 25M and SARGENT REM lever



McKinney 2 knuckle hinge with square end tips



Rockwood small MegaTek pull

# ASSA ABLOY

The global leader in door opening solutions

800-458-2424 | [www.rockwoodmfg.com](http://www.rockwoodmfg.com)  
Check the web site for the up-to-date catalog

Copyright © 2013-2017, Rockwood Manufacturing Company, an ASSA ABLOY Group company. All rights reserved. Reproduction in whole or in part without the express written permission of Rockwood Manufacturing Company is prohibited.

## Push Bars/Pull Bars

### PUSH AND PULL BARS

Push and pull bar sets are available with an assortment of components and mounting applications which provide ample opportunity for meeting your individual requirements. These push bars are custom made to the center-to-center dimension required to fit your doors.



Straight (1" Diameter)

No.	CTC Pull/Push
11047	8" x specify
111A47	9" x specify
11147	10" x specify
11247	12" x specify

Offset (1" Diameter)

No.	CTC Pull/Push
BF15647	8" x specify
BF157A47	9" x specify
BF15747	10" x specify
BF15847	12" x specify



Straight (1 1/4" - 1 1/2" Diameter)

No.	CTC Pull/Push	Dia.
RM351	12" x specify	1 1/4"
RM352	18" x specify	1 1/4"
RM371	12" x specify	1 1/2"
RM372	18" x specify	1 1/2"

Offset (1 1/4" - 1 1/2" Diameter)

No.	CTC Pull/Push	Dia.
RM251	12" x specify	1 1/4"
RM252	18" x specify	1 1/4"
RM271	12" x specify	1 1/2"
RM272	18" x specify	1 1/2"

### PUSH BARS

These 1" diameter push bars with base plates are available in standard and special architectural finishes. They meet ANSI 156.6 standards. These push bars are custom made to the center-to-center dimension required to fit your doors.



No.	CTC	Projection
BP47	specify	2 7/8"
BP47-2	specify	2 7/8"
BP47-3	specify	2 7/8"

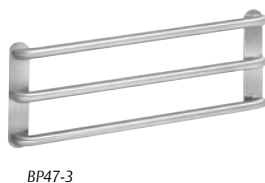

## Door Stops & Silencers

### WALL BUMPERS

Durable and simple to install and have the added advantage of concealed fastenings. They are readily available from stock in other standard architectural finishes and in both cast and wrought materials. Plastic Toggle mount with SMS.

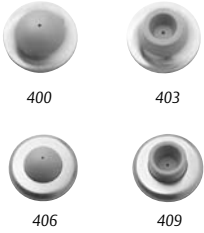

No.	Bumper	Material	Size
400	Convex	Cast	2 <sup>7</sup> / <sub>16</sub> " Dia.
403	Concave	Cast	2 <sup>7</sup> / <sub>16</sub> " Dia.
406	Convex	Wrought	2 <sup>1</sup> / <sub>2</sub> " Dia.
409	Concave	Wrought	2 <sup>1</sup> / <sub>2</sub> " Dia.

### DOMESTOPS

Made from solid brass. Risers are also available for use in carpeted/non-carpeted installations and provide a stable base for mounting the dome stop. Available in most architectural finishes.



No.	Material	Base Size	Height
440	Cast Brass	1 <sup>1</sup> / <sub>4</sub> "h x 1 <sup>7</sup> / <sub>8</sub> " Dia.	1 <sup>1</sup> / <sub>8</sub> "
441H	Cast Brass	7 <sup>7</sup> / <sub>32</sub> "h x 1 <sup>7</sup> / <sub>8</sub> " Dia.	1 <sup>11</sup> / <sub>16</sub> "
442	Cast Brass	1 <sup>1</sup> / <sub>2</sub> "h x 1 <sup>7</sup> / <sub>8</sub> " Dia.	1 <sup>1</sup> / <sub>2</sub> "
446	Brass	1 <sup>1</sup> / <sub>4</sub> " Dia.	1 <sup>1</sup> / <sub>2</sub> "

### ROLLER STOPS

Designed to prevent interfering doors from damaging each other. Available in most architectural finishes.



No.	Material	Base	Projection
455	Cast Brass	1 <sup>5</sup> / <sub>8</sub> " x 2 <sup>1</sup> / <sub>4</sub> "	2 <sup>3</sup> / <sub>4</sub> "
456-RKW	Cast Brass	2" Dia.	4 <sup>9</sup> / <sub>16</sub> "
456L	Cast Brass	2" Dia.	6 <sup>1</sup> / <sub>4</sub> "

### KICK DOWN DOOR STOPS

The #461 features a unique patent assembly that allows no axle pin to show in the base and also provides a locating means that holds the door holder arm in the proper position.



No.	Material	Base	Projection
460	Aluminum	2 <sup>1</sup> / <sub>16</sub> " x 1 <sup>3</sup> / <sub>8</sub> "	4"
461	Cast Brass	2 <sup>1</sup> / <sub>4</sub> " x 1 <sup>1</sup> / <sub>4</sub> "	3 <sup>5</sup> / <sub>8</sub> "
461L	Cast Brass	2 <sup>1</sup> / <sub>4</sub> " x 1 <sup>1</sup> / <sub>4</sub> "	5"

# ASSA ABLOY

The global leader in  
door opening solutions

800-458-2424 | [www.rockwoodmfg.com](http://www.rockwoodmfg.com)  
Check the web site for the up-to-date catalog

Copyright © 2013-2017, Rockwood Manufacturing Company, an ASSA ABLOY Group company. All rights reserved.  
Reproduction in whole or in part without the express written permission of Rockwood Manufacturing Company is prohibited.



## Door Stops & Silencers

### HEAVY DUTY DOOR STOPS

Specially designed for use in rugged situations and security areas. The resilient bumper is fire retardant.

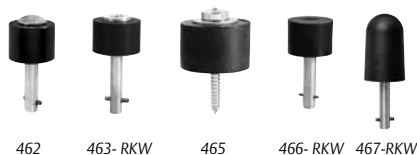

No.	Size	No.	Size
462	2"d x 1½"h	466- RKW	2"d x 1½"h
463- RKW	2"d x 1¾"h (Torx)	467- RKW	2"d x 3½"h
465	3¼" dia. x 2⅝"h		

### DOOR STOPS

Our clean design and solid casting make these Rockwood door stops a decorative and functional alternative to other styles of stops. They are available in most architectural finishes.



No.	Material	Base	Height/Projection
470-471	Cast Brass	2½" Dia.	3"
472-473	Cast Brass	2½" Dia.	3¾"
474-475	Cast Brass	2¼" Dia.	3¾"
476-477	Cast Brass	2¼" Dia.	3¾"
480-481	Cast Brass	2½" x 1¾"	1⅝"
482	Cast Brass	1½" x 2½"	2⅛"
483	Cast Brass	1⅝" x 2⅝"	2¾"
485	Cast Brass	1⅝" x 2⅝"	3"
486	Steel	1" x 2½"	2⅝"
487	Cast Brass	2¼" x 3"	3¾"

### AUTOMATIC DOOR HOLDER & STOPS

Designed for use in commercial buildings where it is desirable to hold a door open on a frequent basis.

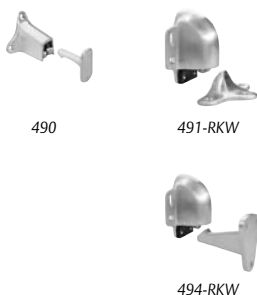

No.	Clearance
490	3¾" wall-to-door
491-RKW	½" or less door-to-floor
494-RKW	3¾" wall-to-door

### DOOR SILENCERS

Rubber door silencers for wood and metal doors.



No.	Size	Frame Type
608- RKW	½" dia. x ⅝"	Metal
609	⅜" x ¾"	Wood

800-458-2424 | [www.rockwoodmfg.com](http://www.rockwoodmfg.com)

Check the web site for the up-to-date catalog

Copyright © 2013-2017, Rockwood Manufacturing Company, an ASSA ABLOY Group company. All rights reserved.  
Reproduction in whole or in part without the express written permission of Rockwood Manufacturing Company is prohibited.

**ASSA ABLOY**

The global leader in  
door opening solutions

## Bolts/Coordinators

### UL LISTED AUTOMATIC FLUSH BOLTS

The patented non-handed cam triggering device is the heart of this smooth-acting mechanism; only five pounds of force is required to drive a pair of bolts allowing door closing devices to perform at maximum efficiency. An override feature prevents damage to doors or bolts should the bolt heads be prevented from penetrating either the top or bottom strikes. The bolts are adjustable for unusual clearance or conditions and have a thermal lock that automatically locks the inactive door under high heat conditions due to fire.

- #2960 - for use on fire rated 20-minute wood core and composite doors up to 4'w x 9'h.
- #2962 - for use on fire rated wood core and composite doors up to 1½ hours fire rating up to 4'w x 9'h. Sold in sets.
- #2842 - for use on the inactive leaf of a pair of A, B, C, D, and E labeled metal doors up to 4'w x 8'h. Sold in sets.
- #2942 - for use on the inactive leaf of a pair of B, C, D, and E labeled wood covered composite doors up to 4'w x 8'h. Sold in sets.
- #2848 - for use on fire rated metal doors labeled A, B, C, D, & E up to 4'w x 9'h.
- #2948 - for use on fire rated 20-minute wood core and composite doors up to 4'w x 9'h.

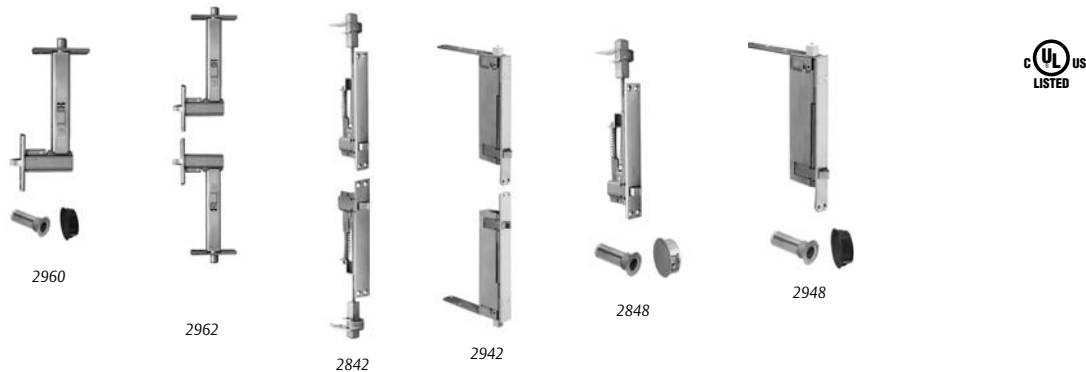

### UL LISTED COMBINATION FLUSH BOLTS

The combination flush bolt uses one automatic flush bolt for the bottom of the door and a constant self-latching flush bolt for the top of the door. When the active leaf is opened, the bottom automatic flush bolt is opened. However the inactive leaf stays latched at the top until it is manually released by depressing the plunger on the bolt face. The top bolt engages each time the inactive door is closed.

- #2845 - for use on A, B, C, D, and E labeled metal doors up to 4'w x 8'h. Sold in sets.
- #2945 - for use on B, C, D, and E labeled wood covered composite doors up to 4'w x 8'h. Sold in sets.
- #2849 - for use on A, B, C, D, and E labeled metal doors up to 4'w x 8'h.
- #2949 - for use on fire rated 20-minute wood core and composite doors up to 4'w x 9'h.



# ASSA ABLOY

The global leader in  
door opening solutions

800-458-2424 | [www.rockwoodmfg.com](http://www.rockwoodmfg.com)  
Check the web site for the up-to-date catalog

Copyright © 2013-2017, Rockwood Manufacturing Company, an ASSA ABLOY Group company. All rights reserved.  
Reproduction in whole or in part without the express written permission of Rockwood Manufacturing Company is prohibited.

## Bolts/Coordinators

### FLUSH AND SURFACE BOLTS

Smooth acting with sturdy construction.



555 Flush Bolts - UL listed for use on A, B, C, D, and E labeled metal doors. Standard rod length is 12". Other lengths are available to order.

No.	Size
555	1" x 6 <sup>3</sup> / <sub>4</sub> "
556WS*	1" x 6 <sup>3</sup> / <sub>4</sub> "

\*for windstorm assemblies

557 Flush Bolts - UL listed for all types of labeled wood fire doors. Door strength is maintained by a reinforcing plate. Simple installation instructions are enclosed in each box.

No.	Size
557	1" x 6 <sup>3</sup> / <sub>4</sub> "

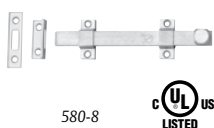

580 Series Surface Bolts - Heavy duty and UL listed for use on the inactive leaf of a pair of labeled fire doors.

No.	Bolt Length
580-8	8"
580-12	12"
580-18	18"
580-24	24"

630 Series Surface Bolts - Have an unique fiber gasket providing slide resistance without marring surface of bolt.

No.	Overall Size
630-4	1 <sup>5</sup> / <sub>8</sub> " x 4 <sup>3</sup> / <sub>8</sub> "
630-8	1 <sup>5</sup> / <sub>8</sub> " x 8"
630-12	1 <sup>5</sup> / <sub>8</sub> " x 12"
630-24	1 <sup>5</sup> / <sub>8</sub> " x 24"

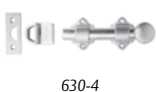

### COORDINATORS

The 2600 non-handed coordinator (with companion filler) is designed to become an integral part of the door frame and when painted with the frame becomes virtually invisible. It is engineered to prevent damage in case of abnormal force against the door that is held open. The 1700 Universal Coordinator manages the operation of a pair of doors ensuring that the inactive leaf closes prior to the active leaf.



No.	Opening
2660	60"
2672	72"
2696	96"
1700	up to 96"

### DUST PROOF STRIKE

Designed to work with any of our flush bolts. Use of these strikes eliminates the problem of floor strikes being clogged with dirt and debris. This combo unit can be used in any situation with or without the removable face plate.



No.	Opening
570	Face Plate: 1 <sup>3</sup> / <sub>8</sub> " x 2 <sup>7</sup> / <sub>8</sub> " Barrel: 7/8" dia. x 2" depth

## Viewers/Signs

### DOOR VIEWERS

The #620 door viewer features undistorted 160° field of vision. The #622 features a wide angle 190° field of vision. The #624 & #626 door viewers feature privacy covers to prevent visual intrusion from outside of the room. (#624 is a 160° viewer and #626 is a 190° viewer). They are all UL listed.



### #670 SERIES ENGRAVED SIGNS

These plastic or metal signs are available in .125" thick black or brown plastic or .050" thick aluminum, brass, bronze, or stainless steel. Standard letter size is 1"h x 1/8"w stroke. Sign size is determined by the height and length of the engraving. Conforms to ANSI 156.16 standards.



### BF SERIES ADA TACTILE SIGNS

These 8" x 8" tactile signs are available in .125" thick non-glare plastic or .050" thick aluminum, brass, bronze, or stainless steel. Easy to read lettering with Grade 2 braille translation. Plastic meets ADAAG section 4.30 requirements.



### BFM SERIES ADA MOLDED PLASTIC SIGNS

These 6" x 9" signs have easy to read raised lettering with Grade 2 braille translation. Choice of blue or black background with 1" white lettering. Meets ADAAG section 4.30 requirements. The BFM624 (12" diameter) and BFM625 are only available with a blue background.

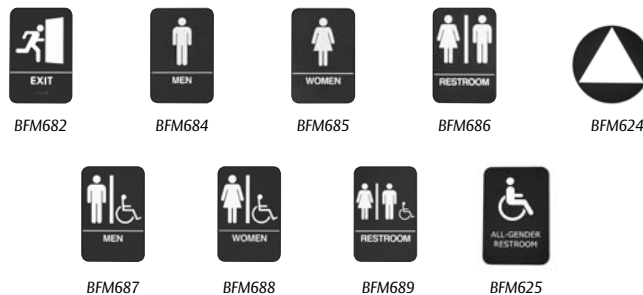

**ASSA ABLOY**

The global leader in  
door opening solutions

800-458-2424 | [www.rockwoodmfg.com](http://www.rockwoodmfg.com)  
Check the web site for the up-to-date catalog

Copyright © 2013-2017, Rockwood Manufacturing Company, an ASSA ABLOY Group company. All rights reserved.  
Reproduction in whole or in part without the express written permission of Rockwood Manufacturing Company is prohibited.

## Door Protectors/Strikes

### KICK PLATES

Rockwood door plates are available for immediate shipment in all standard sizes and finishes. Standard metal thickness is .050"; however, a thinner economy gauge is available in US32D/630 stainless steel. Other thicknesses are also available. Door plates meet all ANSI A156.6 requirements.



#### Metal Kick Plates - Standard

No.	Material
K1050	.050"
K1050F	.050"

#### Metal Kick Plates - Extra Heavy Duty

No.	Material
K1125 DIA	.125"

Available in Brass, Bronze, Stainless, and Diamond Plate Aluminum.

#### Plastic Kick Plates - Heavy Duty

No.	Material
K2060	.060"
K2060SA-F	.060" Self-Adhesive

Available in Beige, Calcutta Black, Chocolate Brown, and Pewter Gray.

#### Clear Plastic Kick Plates

No.	Material
K4125	.125"

#### Shaped Kick Plates - Stainless Steel

No.	Material
K1050A-3	.050"

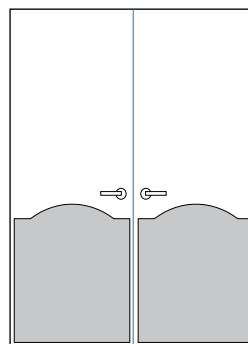

### DOOR EDGES

Most door edges are fabricated from .050" thick stainless steel; however, they are available in other metals and finishes. UL fire rated listed for stainless steel non-mortise applications; specify UL when ordering. These door edges are sized for 1<sup>3</sup>/<sub>4</sub>" thick wood or metal doors. 306-AST and 306B-AST include an astragal, providing additional protection against vandalism.



No.	Material	Edge
306- RKW	.050"	Square
306-AST	.050" w/Astragal	Square
306B	.050"	Bevel
306B-AST	.050" w/Astragal	Bevel

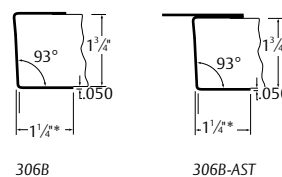
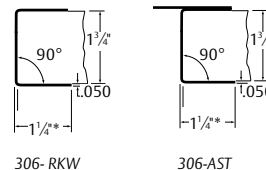

### CORNER PROTECTORS

Corner Protectors — Corners of walls often suffer heavy abuse. Rockwood's corner guards are designed to prevent damage. Available in .050" thick stainless steel, brass and bronze. All materials have high impact strength and are easily made to your required size. Standard sizes include: 2" x 2" x 40", 2" x 2" x 48", 3" x 3" x 40", 3" x 3" x 48".



No.	Mounting	Size
290	Adhesive	Specify
295	Screw	Specify

## Door Protectors/Strikes

### LOCK PROTECTORS

Heavy duty 12 gauge protection for latch bolts available in zinc plated steel or stainless steel. Part No. 320C, 320CL and 320CXL are notched for cylindrical locksets.

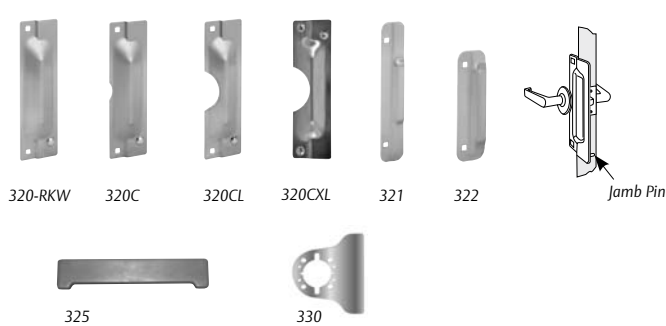

No.	Size
320- RKW	3" x 11"
320C	3" x 11"
320CL	3" x 11"
320CXL	3" x 11"
321	1 1/2" x 10"
322	1 5/8" x 6"
325	1 7/8" x 9 1/2"
330	5 3/8" x 6"

### TRIM PROTECTOR BARS

Our line of patented trim protector bars is designed to safely deflect traffic away from exit devices, door knobs/levers or other trim. The bars are mounted either directly below, over, or in front of the trim depending on the application. If you require a custom design, our engineering department can work to meet your needs.

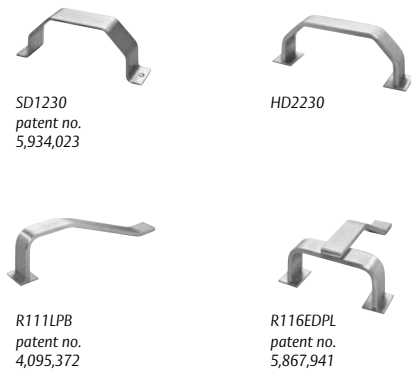

No.	Projection	CTC
SD1230	3 1/4"	8"
SD1240	3 3/4"	8"
SD1250	4 1/4"	8"
SD1260	3 1/4"	8"
HD2230	3 1/4"	8"
HD2240	3 3/4"	8"
HD2250	4 1/4"	8"
R101LPB	3 1/4"	12"
R111LPB	3 1/4"	12"
R115LPB	3 1/4"	14"
R116EDPL	3 1/4"	7 1/2"
R116EDPH	4 1/2"	8 1/2"

### CUSTOM STRIKES

Custom strikes are available by providing us with measurements for your special strike requirements. Lock strikes are .090" thick, unless otherwise specified.



# ASSA ABLOY

The global leader in door opening solutions

800-458-2424 | [www.rockwoodmfg.com](http://www.rockwoodmfg.com)  
Check the web site for the up-to-date catalog

Copyright © 2013-2017, Rockwood Manufacturing Company, an ASSA ABLOY Group company. All rights reserved. Reproduction in whole or in part without the express written permission of Rockwood Manufacturing Company is prohibited.

## Latches/Guards/Catches

### ROLLER LATCHES

These heavy duty roller latches have a variety of strikes to suit several different conditions. The latches feature heavy duty springs and solid nylon rollers for long life. They are adjustable to compensate for varying door to jamb clearance.



No.	Latch Face	Strike
590	1" x 3 <sup>3</sup> / <sub>8</sub> "	1 <sup>11</sup> / <sub>16</sub> " x 2 <sup>1</sup> / <sub>4</sub> "
591	1" x 3 <sup>3</sup> / <sub>8</sub> "	1 <sup>1</sup> / <sub>4</sub> " x 4 <sup>7</sup> / <sub>8</sub> "
592	1" x 3 <sup>3</sup> / <sub>8</sub> "	1 <sup>1</sup> / <sub>8</sub> " x 2 <sup>3</sup> / <sub>4</sub> "
594	1 <sup>1</sup> / <sub>8</sub> " x 2 <sup>1</sup> / <sub>4</sub> "	1 <sup>1</sup> / <sub>8</sub> " x 2 <sup>3</sup> / <sub>4</sub> "

### HOSPITAL LATCH

The Rockwood 596 Push/Pull Latch offers a flexible, durable, easy-to-operate solution for hospitals, washrooms and public buildings. Just a gentle pull or push on the paddle allows the door to be easily opened when hands are not free. The 596 latch is available in stainless steel with an option for MicroShield® antimicrobial coating and has been tested to over 1,000,000 cycles to ensure years of trouble-free operation. UL listed for use on fire rated doors.

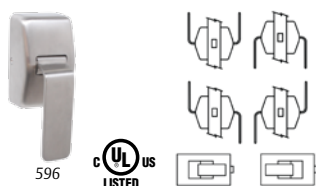

No.	Backset
596	5"
596S	2 <sup>3</sup> / <sub>4</sub> "
596L	7"

U.S. Patent No. 6,398,274 B1

### DOOR GUARDS & PRIVACY LATCH

Our #603 and #604 security door guards are easier to use than a chain door guard and eliminate the marring of the door frame caused by chain door guards. The PDL is designed to enhance privacy and the feeling of safety and security in hotels, residences, dorm rooms and more. UL classified as a fire door accessory.

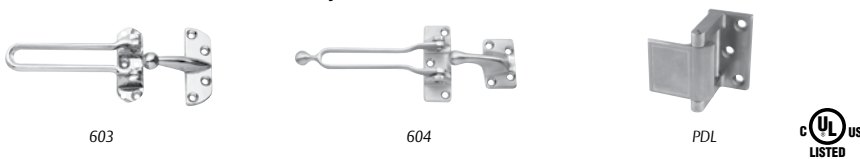

### EDGE GUARD

The #605 edge guard is designed to protect the door or frame from marring when used in conjunction with a #603 or #604 door guard.



### WALL GUARD

With a clear adhesive mount.

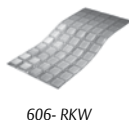

### MAGNETIC CATCHES

The heavy duty #900 catch includes a dual double-pole with self-aligning magnets. The #901 is extra heavy duty and includes a dual triple-pole with self-aligning magnets. Both can be used on pair of doors or single door.



ASSA ABLOY is the global leader in door opening solutions, dedicated to satisfying end-user needs for security, safety and convenience.

**ASSA ABLOY**



ASSA ABLOY  
300 Main Street  
Rockwood, Pennsylvania 15557  
Phone: (800) 458-2424 • Fax: (800) 922-9212  
[www.rockwoodmfg.com](http://www.rockwoodmfg.com) • [orders.rockwood@assaabloy.com](mailto:orders.rockwood@assaabloy.com)

Copyright © 2012-2017, Rockwood Manufacturing Company, an ASSA ABLOY Group company. All rights reserved. Reproduction in whole or in part without the express written permission of Rockwood Manufacturing Company is prohibited.

RM100 12/17  
2500-2555C