



ROCKWOOD®
ASSA ABLOY

Experience a safer
and more open world

ROCKWOOD
CATALOG – ACCESSORIES

Table of Contents

Page #

General Information	1-10
Section A – Push and Pull Bars	A1-A21
Push and Pull Bar Mounting Details	A1
Push Bars	A2-A3
Pull Bars	A4
Push and Pull Bar Sets	A5-A9
Series 47 Push and Pull Bar Mounting Details	A10
Series 47 Solid & Tubular Push Bars	A11-A12
Series 47 Solid Straight/Offset Push & Pull Bar Sets	A13-A18
Series 47 Tubular Straight/Offset Push & Pull Bar Sets	A19-A21
Section B – Push and Pull Plates, Door Pulls	B1-B35
Push Plate Order Information	B1
Push Plates	B2-B7
Flush Pulls	B8-B12
Straight Door Pulls Mounting Details	B13
Straight Door Pulls	B14-B22, B35
Pull Plates	B23-B26
Offset Door Pulls Mounting Details	B27
Offset Door Pulls	B28-B32
Door Pulls	B33
Hands Free Pulls	B34-B35
Vandal Resistant Trim	B36-B37
Vandal Resistant Pull	B38
Section C – Door Plates, Door Edges & Protectors	C1-C26
Door Plates	C1-C6
Angle Plates	C7
Door Edges (Mortise, Non-Mortise, Overlapping)	C8-C9, C12
Door Edge Order Forms & Worksheets	C10-C15
Trim Protector Bars	C16-C20
Vertical Rod Covers	C21
Custom Strikes	C22-C23
Corner Guards	C24
Latch Protectors	C25-C26
Section D – Stops	D1-D24
Wall Stops	D1-D3
Dome Stops	D4-D5
Roller Stops	D6
Door Stops	D7-D19
Automatic Door Stops	D16-D17
Heavy Duty Door Stops	D9-D10
Overhead Holders & Stops	D20-D24
Section E – Bolts and Latches	E1-E20
Flush Bolts	E1-E4
Strikes & Coordinators	E4
Surface Bolts	E5
Roller Latches	E6-E7
Gate Latch & Door Guards	E8
Door Guards & Silencers	E9
Surface & Flush Bolts	E10
Door Coordinators	E11-E12
Automatic & Combination Flush Bolts	E13-E15
Bottom Fire Bolts	E17
Automatic Flush Bolts	E18
Self Latching Flush Bolts	E19
Pivots	E19-E20
Section F – Auxiliary Hardware	F1-F18
Door Knockers & Viewers	F1-F2
Door Signs	F2-F6
Hand Rail Brackets	F7
Coat Hooks	F8
Pulls, Flush Pulls, Edge & Pocket Pulls	F9-F11
Magnetic Catches, Ball Catches	F12-F13
Filler Plates & Shims	F14-F18

ROCKWOOD®**ASSA ABLOY**Experience a safer
and more open world800 458 2424 | www.rockwoodmfg.com
Check the web site for the up-to-date catalog

Copyright © 2012-2024, ASSA ABLOY Accessories and Door Controls Group, Inc. All rights reserved. Reproduction in whole or in part without the express written permission of ASSA ABLOY Accessories and Door Controls Group, Inc. is prohibited.

No.	Description	Page	No.	Description	Page
10-PB	Push Bar.....	A2	94P	Flush Pull.....	B10
11-PB	Push Bar.....	A2	94P x 94L	Flush Pull Set.....	B10
12-PB	Push Bar.....	A2	95A	Flush Pull.....	B11
14-PB	Push Bar.....	A3	95B	Flush Pull.....	B11
15-PB	Push Bar.....	A3	95R	Flush Pull - Round.....	B11
18-PB	Push Bar.....	A3	96	Flush Pull.....	B12
18BFB	Bottom Fire Bolt - Metal Door.....	E16	102-RKW	Straight Door Pull.....	B14
19-PB	Push Bar.....	A3	102 x 70	Pull Plate.....	B23
19BFB	Bottom Fire Bolt - Wood Door.....	E16	105	Straight Door Pull.....	B14
20-PB	Pull Bar.....	A4	105 x 70	Pull Plate.....	B23
21-PB	Pull Bar.....	A4	106-RKW	Straight Door Pull.....	B14
22-PB	Pull Bar.....	A4	106 x 70	Pull Plate.....	B23
23-PB	Pull Bar.....	A4	107	Straight Door Pull.....	B14
25-PB	Push Bar.....	A5	107 x 70	Pull Plate.....	B23
26-PB	Push Bar.....	A5	108	Straight Door Pull.....	B14
27-PB	Push Pull Bar Set.....	A5	109	Straight Door Pull.....	B14
28-PB	Push Pull Bar Set.....	A5	110-RKW	Straight Door Pull.....	B14
29-PB	Push Pull Bar Set.....	A5	110 x 70	Pull Plate.....	B23
30-PB	Push Pull Bar Set.....	A5	110-6SP	Security Door Pull.....	B16
31-PB	Pull Bar.....	A6	111	Straight Door Pull.....	B14
32-PB	Pull Bar.....	A6	111 x 70	Pull Plate.....	B23
33-PB	Push Bar.....	A6	111A	Straight Door Pull.....	B14
34-PB	Push Bar.....	A6	112	Straight Door Pull.....	B14
35-PB	Push Pull Bar Set.....	A6	118	Straight Door Pull.....	B14
36-PB	Push Pull Bar Set.....	A6	120	Door Pull.....	B18
40-PB	Screen Door Guard.....	A7	121	Door Pull.....	B18
41-PB	Screen Door Guard.....	A7	122-RKW	Door Pull.....	B18
42-PB	Screen Door Guard.....	A7	122 x 70	Pull Plate.....	B24
43-PB	Push Bar.....	A8	123	Door Pull.....	B18
44-PB	Push Bar.....	A8	123 x 70	Pull Plate.....	B24
45-PB	Push Bar.....	A8	125-RKW	Door Pull.....	B19
47 Series	Series 47 Push Bar.....	A11	125 x 70	Pull Plate.....	B24
48-PB	Series 47 Push Bar.....	A11	126-RKW	Door Pull.....	B19
49-PB	Push Bar.....	A12	126 x 70	Pull Plate.....	B24
50-PB	Pull Bar.....	A9	130-RKW	Cast Door Pull.....	B19
51-PB	Push Bar.....	A9	131-RKW	Cast Door Pull.....	B19
52-PB	Push Pull Bar Set.....	A9	132-RKW	Cast Door Pull.....	B20
53-PB	Door Pull.....	A9	132 x 70	Pull Plate.....	B25
70 Series	Push Plate - .050".....	B2	134-RKW	Cast Door Pull.....	B20
71 Series	Push Plate - .062".....	B3	137	Cast Door Pull.....	B21
73 Series	Push Plate - .125".....	B4	137 x 70	Pull Plate.....	B25
73BL	Concealed Mount Push Plate.....	B16	137L	Cast Door Pull.....	B21
73CL	Concealed Mount Push Plate.....	B16	138	Cast Door Pull.....	B21
75 Series	Push Plate - .125".....	B5	139	Cast Door Pull.....	B21
76 Series	Decorative Push Plate - .050".....	B6	147	Door Pull.....	B22
77 Series	Decorative Push Plate - .050".....	B6	147 x 76	Pull Plate.....	B26
80	Push Plate - .050".....	B6	147 x 77	Pull Plate.....	B26
81	Push Plate - .050".....	B6	147L	Door Pull.....	B22
82	Push Plate - .050".....	B6	148	Door Pull.....	B22
84	Push Plate - .050".....	B6	148 x 76	Pull Plate.....	B26
85	Push Plate - .050".....	B7	148 x 77	Pull Plate.....	B26
86	Push Plate - .050".....	B7	149	Door Pull.....	B22
87	Push Plate - .125".....	B7	185	Offset Door Pull.....	B32
90	Cylinder Pull.....	B8	190	90° Straight Door Pull.....	B33
90B	Cylinder Pull.....	B8	193	Hand/Arm Pull.....	B34
91-RKW	Combination Push Pull Plate.....	B8	208	Wooden Door Pull.....	B33
92-RKW	Combination Push Pull Plate.....	B8	215	Tapered Door Pull.....	B33
93-RKW	Combination Push Pull Plate.....	B8	215L	Tapered Door Pull.....	B33
94	Flush Pull.....	B9	290	Corner Guard.....	C24
94BTB	Flush Pull.....	B9	291	Corner Guard.....	C24
94C	Flush Pull.....	B9	295	Corner Guard.....	C24
94DLL	Dead Lock Flush Pull.....	B9	296	Corner Guard.....	C24
94DLS	Dead Lock Flush Pull.....	B9	300	Mortise Door Edge.....	C8
94L	Flush Pull.....	B10			

No.	Description	Page
301	Mortise Door Edge	C8
302	Mortise Door Edge	C8
302B	Mortise Door Edge	C8
304	Non-Mortise Door Edge	C9
305	Non-Mortise Door Edge	C9
306-RKW	Non-Mortise Door Edge	C9
306-AST	Non-Mortise Door Edge	C9
306B	Non-Mortise Door Edge	C9
306B-AST	Non-Mortise Door Edge	C9
307	Non-Mortise Door Edge	C9
308	Overlapping Door Edge	C12
309	Overlapping Door Edge	C12
310	Overlapping Door Edge	C12
310B	Overlapping Door Edge	C12
310BS	Overlapping Door Edge	C12
310S	Overlapping Door Edge	C12
320-RKW	Latch Protector	C25
320C	Latch Protector	C25
320CL	Latch Protector	C25
320CXL	Latch Protector	C25
321	Latch Protector	C25
322	Latch Protector	C26
325	Latch Protector	C26
330	Latch Protector	C26
400	Solid Cast Wall Stop	D1
401	Solid Cast Wall Stop	D1
402	Solid Cast Wall Stop	D1
403	Solid Cast Wall Stop	D1
404	Solid Cast Wall Stop	D1
405	Solid Cast Wall Stop	D1
406	Wrought Wall Stop	D1
409	Wrought Wall Stop	D1
412	Solid Cast Wall Stop	D2
415	Solid Cast Wall Stop	D2
416	Solid Cast Wall Stop	D2
426	Wall Stop	D3
430-RKW	Solid Cast Wall Stop	D3
431-RKW	Wall Stop	D3
432W	Wall Stop	D3
440	Low Dome Stop	D4
441	Low Dome Stop	D4
441CU	Dome Stop Combination Unit	D4
441H	Cast Universal Dome Stop	D5
442	High Dome Stop	D5
443	High Dome Stop	D5
444	Cast Door Stop Riser	D5
445	Heavy Duty Door Stop	D5
445H	Heavy Duty Door Stop	D5
446	Door Stop	D6
449	Door Stop Riser	D6
455	Curved Roller Stop	D6
456-RKW	Straight Roller Stop	D6
456L	Straight Roller Stop	D7
458	Kick Down Door Stop	D7
459	Spring Loaded Plunger Stop	D7
460	Kick Down Door Stop	D7
461	Kick Down Door Stop	D8
461L	Kick Down Door Stop	D8
462	Heavy Duty Door Stop	D9
463-RKW	Heavy Duty Door Stop	D9
464-RKW	Heavy Duty Door Stop w/Holder	D9
465	Heavy Duty Door Stop	D9
466-RKW	Heavy Duty Door Stop	D10
467-RKW	Heavy Duty Door Stop	D10

No.	Description	Page
468-RKW	Heavy Duty Door Stop	D10
470	Door Stop	D11
471	Door Stop	D11
472	Door Stop w/Keeper	D11
473	Door Stop w/Keeper	D11
474	Door Stop	D11
475	Door Stop	D11
476	Door Stop w/Keeper	D12
477	Door Stop w/Keeper	D12
480	Door Stop	D12
480H	Door Stop	D12
481	Door Stop	D13
481H	Door Stop	D13
481MP	Door Stop	D13
482	Door Stop	D14
483	Door Stop	D14
485	Door Stop w/Keeper	D14
486	Angle Door Stop	D15
487	Heavy Duty Wall Stop	D15
488	Door Stop	D15
489	Door Stop	D15
490	Door Holder & Stop	D16
491-RKW	Automatic Door Holder & Stop	D16
491R	Automatic Door Holder & Stop	D16
491S	Automatic Door Holder & Stop	D16
494-RKW	Automatic Door Holder & Stop/Foot Pull ...B35, D17	D17
494R	Automatic Door Holder & Stop	D17
494S	Automatic Door Holder & Stop	D17
495	Concealed Magnetic Door Stop	D17
505-RKW	Door Stop	D18
508	Door Stop	D18
517	Aluminum Door Stop	D18
518	Door Stop	D18
519	Door Stop	D18
520	Replacement Bumper	D18
525	Spring Base Door Stop	D19
526	Spring Base Door Stop	D19
528	Hinge Pin Stop	D19
550	Lever Extension Flush Bolt	E1
554	Rabbet Piece	E1
554G	Rabbet Guide	E1
554S	Rabbet Guide	E1
555	Lever Extension Flush Bolt	E2
555 x 18BFB	Lever Extension Flush Bolt	E2
556WS	Lever Extension Flush Bolt	E3
557	Lever Extension Flush Bolt	E3
557 x 19BFB	Lever Extension Flush Bolt	E4
570	Dust Proof Strike	E4
576	Gravity Door Coordinator	E4
580 Series	Surface Bolts	E5
582 Series	Surface Bolts	E5
585 Series	Heavy Duty Surface Bolts	E5
590	Roller Latch w/Cast Strike	E6
590DA	Roller Latch w/Double Acting Strike	E6
591	Roller Latch w/ASA Strike	E6
592	Roller Latch w/#161 Strike	E7
593	Roller Latch w/Angle Strike	E7
594	Roller Latch w/161 Strike	E7
602	Secret Gate Latch	E8
603	Door Guard w/Shim	E8
604	Door Guard w/Shim	E8
605	Door Guard Protection Plate	E8
605SMS	Door Guard Protection Plate	E8
606-RKW	Door Guard Protection Plate	E9
608-RKW	Door Silencer	E9
608CA	Door Silencer	E9
609	Door Silencer	E9
611	Door Knocker	F1

ROCKWOOD®

ASSA ABLOY

Experience a safer
and more open world

800 458 2424 | www.rockwoodmfg.com
Check the web site for the up-to-date catalog

Copyright © 2012-2024, ASSA ABLOY Accessories and Door Controls Group, Inc. All rights reserved. Reproduction in whole or in part without the express written permission of ASSA ABLOY Accessories and Door Controls Group, Inc. is prohibited.

No.	Description	Page
614	Door Knocker.....	F1
614V	Door Knocker w/Viewer.....	F1
619	160° Door Viewer.....	F1
620	160° Door Viewer.....	F1
620VC	160° Door Viewer.....	F1
621	160° Door Viewer.....	F1
622	190° Door Viewer.....	F2
622VC	190° Door Viewer.....	F2
624	160° Door Viewer.....	F1
626	190° Door Viewer.....	F2
627	190° Door Viewer w/Heavy Duty Cover.....	F2
628	190° Door Viewer w/Heavy Duty Cover.....	F2
629	190° Door Viewer w/Heavy Duty Cover.....	F2
618W	Door Viewer Washer.....	F2
630 Series	Surface Bolts.....	E10
651	Card Holder.....	F2
660	Decal.....	F3
661	Decal.....	F3
662-RKW	Decal.....	F3
670	Engraved Sign - SPECIFY COPY.....	F3
670M	Engraved Sign - MEN.....	F3
670R	Engraved Sign - RESTROOM.....	F3
670W	Engraved Sign - WOMEN.....	F3
674H	Engraved Sign - PUSH.....	F3
674L	Engraved Sign - PULL.....	F3
700	Hand Rail Bracket.....	F7
701	Hand Rail Bracket.....	F7
702	Hand Rail Bracket.....	F7
790	Small Coat Hook.....	F8
796	Small Double Coat Hook.....	F8
802	Medium Coat Hook.....	F8
806	Medium Coat Hook.....	F8
841	Ball Knob.....	F9
845	Utility Pull.....	F9
850	Solid Wire Pull.....	F9
851	Solid Wire Pull.....	F9
852	Solid Wire Pull.....	F9
853	Solid Wire Pull.....	F9
856-RKW	Heavy Wire Pull.....	F9
860	Flush Cup Pull.....	F10
870	Wrought Flush Pull.....	F10
872	Cast Flush Pull.....	F10
880	Cast Lever Edge Pull.....	F11
885	Concealed Edge Pull.....	F11
890	Pocket Door Pull.....	F11
891	Pocket Door Privacy Latch.....	F11
900	Magnetic Catch.....	F12
901	Magnetic Catch.....	F12
910	Adjustable Ball Catch.....	F13
910RC	Adjustable Ball Catch.....	F13
911	Adjustable Ball Catch.....	F13
911RC	Adjustable Ball Catch.....	F13
1100	Carry Bar.....	E12
1700	Door Coordinator.....	E12
2600	Series Door Coordinators.....	E11
2601AB	Mounting Brackets.....	E12
2601C	Mounting Brackets.....	E13
2601D	Mounting Bracket.....	E13
2805	Combination Flush Bolt.....	E14
2840	Automatic Flush Bolt.....	E14
2842	Automatic Flush Bolt Set.....	E14
2845	Combination Flush Bolt Set.....	E14
2848	Automatic Flush Bolt Set.....	E16
2849	Self Latching Flush Bolt (w/bottom fire bolt).....	E18
2905	Combination Flush Bolt.....	E15
2940	Automatic Flush Bolt.....	E15
2942	Automatic Flush Bolt Set.....	E16
2945	Combination Flush Bolt Set.....	E16

No.	Description	Page
2948	Automatic Flush Bolt Set.....	E16
2949	Self Latching Flush Bolt (w/bottom fire bolt).....	E18
2960	Automatic Flush Bolt (w/bottom fire bolt).....	E18
2962	Automatic Flush Bolt Set.....	E18
11047	Straight Push Pull Bar Set.....	A13
11047-2	Straight Push Pull Bar Set.....	A14
11047-3	Straight Push Pull Bar Set.....	A15
111A47	Straight Push Pull Bar Set.....	A13
111A47-2	Straight Push Pull Bar Set.....	A14
111A47-3	Straight Push Pull Bar Set.....	A15
11147	Straight Push Pull Bar Set.....	A13
11147-2	Straight Push Pull Bar Set.....	A14
11147-3	Straight Push Pull Bar Set.....	A15
11247	Straight Push Pull Bar Set.....	A13
11247-2	Straight Push Pull Bar Set.....	A14
11247-3	Straight Push Pull Bar Set.....	A15
11847	Straight Push Pull Bar Set.....	A13
19049	Straight Push Pull Bar Set.....	A22
AP1007	Arm Pull.....	B34
AP1140	Arm Pull.....	B34
AP1141	Arm Pull.....	B34
BF97	Barrier Free Flush Pull.....	B12
BF97L	Barrier Free Flush Pull.....	B12
BF150	90° Offset Door Pull.....	B28
BF151	90° Offset Door Pull.....	B28
BF152	90° Offset Door Pull.....	B28
BF156	90° Offset Door Pull.....	B28
BF15647	Offset Push Pull Bar Set.....	A16
BF15647-2	Offset Push Pull Bar Set.....	A17
BF15647-3	Offset Push Pull Bar Set.....	A18
BF157	90° Offset Door Pull.....	B28
BF157A	90° Offset Door Pull.....	B28
BF157A47	Offset Push Pull Bar Set.....	A16
BF157A47-2	Offset Push Pull Bar Set.....	A17
BF157A47-3	Offset Push Pull Bar Set.....	A18
BF15747	Offset Push Pull Bar Set.....	A16
BF15747-2	Offset Push Pull Bar Set.....	A17
BF15747-3	Offset Push Pull Bar Set.....	A18
BF158	90° Offset Door Pull.....	B28
BF15847	Offset Push Pull Bar Set.....	A16
BF15847-2	Offset Push Pull Bar Set.....	A17
BF15847-3	Offset Push Pull Bar Set.....	A18
BF159	90° Offset Door Pull.....	B28
BF15947	Offset Push Pull Bar Set.....	A16
BF19549	Offset Push Pull Bar Set.....	A22
BF160	45° Offset Door Pull.....	B31
BF161	45° Offset Door Pull.....	B31
BF162	45° Offset Door Pull.....	B31
BF166	45° Offset Door Pull.....	B31
BF167	45° Offset Door Pull.....	B31
BF167A	45° Offset Door Pull.....	B31
BF168	45° Offset Door Pull.....	B31
BF169	45° Offset Door Pull.....	B31
BF169	45° Offset Door Pull.....	B31
BF195	90° Offset Door Pull.....	B32
BF258	Heavy Duty Offset Door Pull.....	B36
BF259	Heavy Duty Offset Door Pull.....	B36
BF260	Heavy Duty Offset Door Pull.....	B36
BF680	Engraved Sign w/Braille - SPECIFY COPY.....	F4
BF680M	Engraved Sign w/Braille - MEN.....	F4
BF680R	Engraved Sign w/Braille - RESTROOM.....	F4
BF680W	Engraved Sign w/Braille - WOMEN.....	F4
BF683	Tactile ADA Sign w/Braille.....	F5
BF684	Tactile ADA Sign w/Braille.....	F5
BF685	Tactile ADA Sign w/Braille.....	F5

ROCKWOOD®

ASSA ABLOY

Experience a safer
and more open world

No.	Description	Page	No.	Description	Page
BF686	Tactile ADA Sign w/Braille	F5	K4125	Clear Plastic Door Plate - .125"	C6
BF687	Tactile ADA Sign w/Braille	F5	KB1150	Angle Plate - .050"	C7
BF688	Tactile ADA Sign w/Braille	F5	KB1151	Angle Plate - .050"	C7
BF689	Tactile ADA Sign w/Braille	F5	KB1152	Angle Plate - .050"	C7
BFLG10	Latch Guard Cover	C21	LA86	Latch Adapter Plate	F17
BFLG12	Latch Guard Cover	C21	LF161	Door Edge Filler Plate.....	F18
BFLG16	Latch Guard Cover	C21	OH100 Series	Concealed Overhead Holder & Stop.....	D20
BFLG1050	Vertical Rod Latch Guard Cover	C21	OH200 Series	Surface Overhead Holder & Stop.....	D22
BFM624	All Gender Restroom Sign	F6	OH900 Series	Surface Overhead Holder & Stop.....	D23
BFM625	All Gender Restroom Sign	F6	OH1000 Series	Surface Overhead Holder & Stop.....	D24
BFM682	Tactile ADA Molded Plastic Sign w/Braille.....	F6	PDLAA	Privacy Door Latch	E9
BFM684	Tactile ADA Molded Plastic Sign w/Braille.....	F6	R101LPB	Trim Protector Bar	C19
BFM685	Tactile ADA Molded Plastic Sign w/Braille.....	F6	R102LPB	Trim Protector Bar	C19
BFM686	Tactile ADA Molded Plastic Sign w/Braille.....	F6	R111LPB	Trim Protector Bar	C19
BFM687	Tactile ADA Molded Plastic Sign w/Braille.....	F6	R112LPB	Trim Protector Bar	C19
BFM688	Tactile ADA Molded Plastic Sign w/Braille.....	F6	R115LPB	Trim Protector Bar	C19
BFM689	Tactile ADA Molded Plastic Sign w/Braille.....	F6	R116EDPH	Exit Device Protector.....	C20
BFRC12	Vertical Rod Cover	C21	R116EDPL	Exit Device Protector.....	C20
BFRC24	Vertical Rod Cover	C21	SD1230	Standard Duty Trim Protector Bar	C18
BP47 Series	Series 47 Push Bar w/Base Plate.....	A12	SD1240	Standard Duty Trim Protector Bar	C18
BP47-2	Series 47 Push Bar w/Base Plate.....	A12	SD1250	Standard Duty Trim Protector Bar	C18
BP47-3	Series 47 Push Bar w/Base Plate.....	A12	SD1260	Standard Duty Trim Protector Bar	C18
CP10 Series	Standard Head Pivot	E20	SF160	Strike Filler Plate	F18
CP40 Series	Standard Floor Pivot	E20	SFASA	Strike Filler Plate	F18
CPK1840	Cover Plate Kit	E17	SFB160	Strike Filler Plate	F18
CS Series	Custom Strikes.....	C22	SP47	Series 47 Push Bar	A11
D89	Security Flush Pull	B8	T47 Series	Tubular Push Bars.....	A19
D133-RKW	Security Loop Door Pull.....	B20	T110 - T112	Tubular Straight Door Pulls.....	B15
DF86	Door Edge Filler Plate.....	F14	T118	Tubular Straight Door Pulls.....	B15
DFF4	Frame Hinge Filler Plate	F14	T11047	Straight Tubular Single Bar Sets	A20
DFF5	Frame Hinge Filler Plate	F14	T111A47	Straight Tubular Single Bar Sets	A20
DHF4B	Beveled Door Hinge Filler Plate	F14	T11147	Straight Tubular Single Bar Sets	A20
DHF4S	Square Door Hinge Filler Plate.....	F15	T11247	Straight Tubular Single Bar Sets	A20
DHF5B	Beveled Door Hinge Filler Plate	F15	T11847	Straight Tubular Single Bar Sets	A20
DHF5S	Square Door Hinge Filler Plate.....	F15	TBF156	Tubular 90° Offset Door Pulls.....	B29
FB-1	Filler Bar	E12	TBF157	Tubular 90° Offset Door Pulls.....	B29
FB-2	Filler Bar	E12	TBF157A	Tubular 90° Offset Door Pulls.....	B29
FBF48	Flush Bolt Filler Plate.....	F15	TBF158	Tubular 90° Offset Door Pulls.....	B29
FBS48	Flush Bolt Strike Filler Plate	F16	TBF159	Tubular 90° Offset Door Pulls.....	B29
FC161	Door Face Filler Plate	F16	TBF15647	Offset Tubular Single Bar Sets.....	A21
FD160	Door Face Filler Plate	F16	TBF157A47	Offset Tubular Single Bar Sets.....	A21
FP1230	Foot Pull.....	B35	TBF15747	Offset Tubular Single Bar Sets.....	A21
HD2230	Heavy Duty Trim Protector Bar	C17	TBF15847	Offset Tubular Single Bar Sets.....	A21
HD2230M	Heavy Duty Trim Protector Bar	C17	TBF15947	Offset Tubular Single Bar Sets.....	A21
HD2240	Heavy Duty Trim Protector Bar	C17	VRT12	Vandal Resistant Trim	B36
HD2240M	Heavy Duty Trim Protector Bar	C17	VRT14	Vandal Resistant Trim	B37
HD2250	Heavy Duty Trim Protector Bar	C17	VRT16	Vandal Resistant Trim	B37
HD2250M	Heavy Duty Trim Protector Bar	C17	VRT22	Vandal Resistant Trim	B36
HS42	4½" Hinge Shim - .028"	F16	VRT24	Vandal Resistant Trim	B37
HS44	4½" Hinge Shim - .065"	F17	VRT26	Vandal Resistant Trim	B37
HS52	5" Hinge Shim - .028"	F17	VRP30	Vandal Resistant Pull.....	B38
HS54	5" Hinge Shim - .065"	F17	Y105 - Y112	Door Pull w/Base Plate	B17
K1038	Metal Door Plate - .038"	C1	Y118	Door Pull w/Base Plate	B17
K1050	Metal Door Plate -.050" (Quick Ship)	C1	YBF150	90° Offset Door Pull w/Base Plate	B30
K1050-1-K1050-8	Shaped Door Plates - .050"	C2	YBF151	90° Offset Door Pull w/Base Plate	B30
K1050A-1-K1050A-8	Shaped Door Plates - .050"	C3	YBF152	90° Offset Door Pull w/Base Plate	B30
K1050F	Metal Door Plate - .050"	C1	YBF156	90° Offset Door Pull w/Base Plate	B30
K1062	Metal Door Plate - .062"	C4	YBF157A	90° Offset Door Pull w/Base Plate	B30
K1125	Metal Door Plate - .125"	C4	YBF157	90° Offset Door Pull w/Base Plate	B30
K2060	Plastic Door Plate - .060"	C5	YBF158	90° Offset Door Pull w/Base Plate	B30
K2125	Plastic Door Plate - .125"	C5	YBF159	90° Offset Door Pull w/Base Plate	B30
K3125	Laminate Plastic Door Plate - .125"	C6			

ROCKWOOD®

ASSA ABLOY

Experience a safer
and more open world

800 458 2424 | www.rockwoodmfg.com
Check the web site for the up-to-date catalog

Copyright © 2012-2024, ASSA ABLOY Accessories and Door Controls Group, Inc. All rights reserved. Reproduction in whole or in part without the express written permission of ASSA ABLOY Accessories and Door Controls Group, Inc. is prohibited.



Rockwood Manufacturing Co. founders, brothers Norman and Vernon Gurzenda

About Rockwood Manufacturing Company

Rockwood Manufacturing Company, founded in 1946 by the Gurzenda Family in rural southwestern Pennsylvania, focuses on the design and manufacture of quality builders' hardware for commercial, institutional and finer residential buildings. Now in the third generation of skilled craftsman, we continue to develop new products and processes that improve our offering. Strict attention to detail from the selection of top-grade materials to the application of the finest finishes results in a tough, yet handsome product of the highest caliber.

In 2008 Rockwood Manufacturing Company was purchased by ASSA ABLOY, the global leader in door opening solutions. This greatly expanded design and development capabilities and expanded the product offering to customers. This offering includes many coordinating products with other ASSA ABLOY Group companies through the Good Design Studio.



Custom Designs

Design your own hardware! Whether it is a modification of a standard product or a completely unique design, we will quote your design and offer suggestions for best mounting applications. We take special pride in our custom products. For more information, please contact our sales staff.



Rockwood Architectural Door Pulls

The alluring warmth of warm wood, smooth leather, clean and appealing lines. Just a few words to describe our beautiful architectural door pulls. With endless design options to choose from, our pulls will add contemporary beauty to any door opening.

Refer to the Rockwood Architectural Door Pulls catalog, found on our web site at www.assaabloydooraccessories.us

the good design studio

The Good Design Studio – your resource for beautiful doors, frames and hardware from ASSA ABLOY Group brands. Visit www.thegooddesignstudio.com to learn more.



CORBIN RUSSWIN 107 and SARGENT ME lever



McKINNEY 2 knuckle hinge with round end tips



ROCKWOOD small door pull



ASSA ABLOY is a member of the USGBC and CaGBC

U.S. Green Building Council logo is a trademark owned by the U.S. Green Building Council and is used with permission.

LEED Certification Contribution

ASSA ABLOY can help to achieve prerequisites and accumulate points in several categories and credit areas of LEED. When you select a Rockwood stainless steel door pull for your LEED certified building project, you are using a product that is made from a minimum 75% post industrial waste and is 100% recyclable. Additionally these pulls can usually be refinished to their original appearance any time in the life of the building, eliminating the need for replacement when a renovation is conducted. For further information, please call 1-800-458-2424 or refer to our website www.rockwoodmfg.com

800 458 2424 | www.rockwoodmfg.com
Check the web site for the up-to-date catalog

Copyright © 2012-2024, ASSA ABLOY Accessories and Door Controls Group, Inc. All rights reserved. Reproduction in whole or in part without the express written permission of ASSA ABLOY Accessories and Door Controls Group, Inc. is prohibited.

ROCKWOOD®
ASSA ABLOY

Experience a safer
and more open world

Sales & Support

Sales

Rockwood Products are represented by a number of sales agencies as well as ASSA ABLOY Door Security Solutions representatives. To locate the representative for your area visit the Sales Representative map in the Contact Us area at www.rockwoodmfg.com, or call 1 800 458 2424.

Ordering Information

Orders are accepted with the understanding that they will be billed at the prices in effect at time of shipment. Prices are subject to change without notice. We reserve the right to decline the whole or part of orders in which the price or quantity of goods is not acceptable to us.

Easy Order Placement

By Phone: 1 800 458 2424 Monday through Friday, 8:00 am ET to 7:30 pm ET

By Fax: Orders may be faxed to 1 800 922 9212

By Email: orders.rockwood@assaabloy.com

By Internet: <http://extranet.assaabloydss.com/> and select Order Entry under the Customer Service Menu

Webshop: Architectural Door Accessories WebShop:
<https://accessories.assaabloy.com/>

Canada:

By Phone: 1 800 461 3007 Monday through Friday, 8:00am ET to 4:30pm ET

By Fax: Orders may be faxed to 1 800 461 8989

By Email: cavau-orders@assaabloy.com

By Internet: <http://extranet.assaabloydss.ca/> and select Order Entry under the Customer Service Menu

Technical Support

Do you have a question? Let us help. Customer Service Representatives are available Monday through Friday, 8:00 am ET to 7:30 pm ET at 1 800 458 2424.

Our website is available 24/7 with current catalogs, sell sheets and the most up-to-date templates.

Visit www.rockwoodmfg.com



Terms & Conditions

Terms and Conditions of Sale

Terms: 1% 15 days, net 30 days

Remit Payment To: PNC Bank/Rockwood,
P.O. Box 644489, Pittsburgh, PA 15264-4489

For Terms & Conditions and Warranty information pertaining to product sales in Canada, please visit www.assaabloy.ca/terms

Freight Policy

All prices are F.O.B. Rockwood, Pennsylvania, and/or Ventura, For freight policy terms & conditions please click [here](#) or see brand price book.

Special Order Material

Special items made to your specifications are not returnable. These items are not subject to cancellation without consideration of expense involved at the cancellation date.

Samples

Saleable samples will be charged at regular prices.

Shortages

Claims for shortages must be made within 30 days of invoice date.

Templates

Upon request we will furnish templates for any of our standard items of manufacture. Commonly used templates are available on our website at www.rockwoodmfg.com

ROCKWOOD®

ASSA ABLOY

Experience a safer
and more open world

800 458 2424 | www.rockwoodmfg.com
Check the web site for the up-to-date catalog

Copyright © 2012-2024, ASSA ABLOY Accessories and Door Controls Group, Inc. All rights reserved. Reproduction in whole or in part without the express written permission of ASSA ABLOY Accessories and Door Controls Group, Inc. is prohibited.

Architectural Finishes

Most Rockwood products are available in all of the following architectural finishes. The catalog indicates exceptions. This finish list is grouped by base metal.

Base Metal	Description	Rockwood Code	BHMA Code
Aluminum	Satin	US27	627
Aluminum	Clear anodized	US28	628
Aluminum	Light bronze anodized	311	—
Aluminum	Medium bronze anodized	312	—
Aluminum	Dark bronze anodized	313	710
Aluminum	Extra dark bronze anodized	314	—
Aluminum	Black anodized	315	711
Aluminum	White powder coat	WPC	—
Aluminum	Red powder coat	RPC	—
Aluminum	Black powder coat	BPC	—
Brass	Polished clear coated	US3	605
Brass	Polished no coating	US3NL	—
Brass	Satin clear coated	US4	606
Brass	Satin oxidized relieved	US5	609
Brass	Satin nickel plated clear coated	US15	619
Brass	Satin nickel blackened relieved clear coated	US15A	620
Brass	Flat black powder coated	US19	622
Brass	Polished chrome plated	US26	625
Brass	Satin chrome plated	US26D	626

Base Metal	Description	Rockwood Code	BHMA Code
Bronze	Polished clear coated	US9	611
Bronze	Satin clear coated	US10	612
Bronze	Black oxidized bronze oil rubbed	US10A	722
Bronze	Satin oxidized oil rubbed	US10B*	613
Bronze	Oxidized equivalent	10BE	613E
Bronze	Satin oxidized clear coated	US10BL	614
Stainless Steel	Polished	US32	629
Stainless Steel	Satin	US32D	630
Bronze	Satin dark statuary	US20A	624

*US10B is a living finish and will patina over time

Special Finishes (see descriptions below)

Stainless Steel	Satin MicroShield® coated	US32DMS**	—
Stainless Steel	Polished 316 alloy	US32316**	—
Stainless Steel	Satin 316 alloy	US32D316**	—
	Black Suede Powder Coat	BSP	—
	White Suede Powder Coat	WSP	—

US32DMS (MicroShield®):

As part of its promise to provide innovative solutions to their customers, ASSA ABLOY Group companies offer the MicroShield® technology, a silver-based antimicrobial coating designed to inhibit the spread of germs and bacteria.

US32316 and US32D316:

Made from alloy 316 stainless steel containing molybdenum and extra nickel giving it substantially higher corrosion resistance than the standard stainless steels typically used in door hardware. This finish is ideal for use in coastal, urban, and industrial areas that have harsh environmental conditions. 32316 (polish) finishes offer the best corrosion resistance and should be used in caustic environments.



MicroShield® is a registered trademark of ASSA ABLOY.



Finish Tips

Polished Brass

Polished brass is a beautiful finish that does not normally weather very well outdoors. Rockwood products use a very durable baked on clear powder coat on most door pulls and push bars. In indoor usage, this finish is extremely durable.

Stainless Steel

Stainless steel is one of the most durable materials used in architecture; however there are many types with different properties and different levels of corrosion resistance. In most indoor (except chlorine and other harsh chemical exposure) and many outdoor (mildly corrosive) environments our standard stainless steel will perform exceeding well. It is best maintained by periodic water washing. If your job site has road salt, marine salt air, industrial, or urban pollution, we recommend the use of molybdenum bearing alloy 316 stainless steel. Specify US32**316** or US32D**316**. To enhance the corrosion resistance of stainless steel, use the polished finish (US32) in place of the satin finish (US32D). Minute particles of dirt and debris can lodge in the microscopic crevices of the satin finish more readily than on a smooth surface promoting corrosion. The mirror smooth surface of the polished finish has no rough surface to retain microscopic dirt or debris.

Heat Resistant

Exterior hot sunny climates call for a finish that is resistant to heat. We recommend our white powder coat finish (WPC). This durable exterior finish reflects much of the heat rays and is substantially cooler to the touch than stainless steel or other finishes.

Anti-Microbial Protection

MicroShield® (US32D**MS**) is the ideal finish for hospitals, schools, laboratories, assisted living facilities, public restroom areas, and anywhere there is a concern to control bacteria growth for demanding standards of cleanliness. Contact our customer service department for more detailed information.

Finish Sample Displays

Educational and informative displays are available showing our most popular finishes.

ROCKWOOD®

ASSA ABLOY

Experience a safer
and more open world

800 458 2424 | www.rockwoodmfg.com
Check the web site for the up-to-date catalog

Copyright © 2012–2024, ASSA ABLOY Accessories and Door Controls Group, Inc. All rights reserved. Reproduction in whole or in part without the express written permission of ASSA ABLOY Accessories and Door Controls Group, Inc. is prohibited.

How to Size Push Bars

Flush Doors

Door width:

- Minus 5" for bent end bars
- Minus 5" for square end post mount bars
- Minus 7" for round end post mount bars

Stile and Rail Doors or Doors with Lites

Door width:

- Minus width of one stile

CAUTION: Always confirm bars will not interfere with jamb or cause pinching hazard.

CAUTION: On narrow stile doors, be sure push bar base fits on the stile and bar does not interfere with the stop.

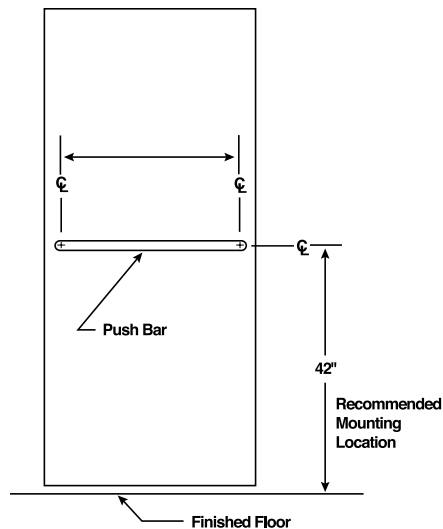

Handing of Doors

The handing of a door is determined from the outside of the opening.

Standing outside the door:

- If the hinges are on the right, it is a right hand door
- If the hinges are on the left, it is a left hand door
- If the door opens away from you, it is a regular bevel door
- If the door opens toward you, it is a reverse bevel door

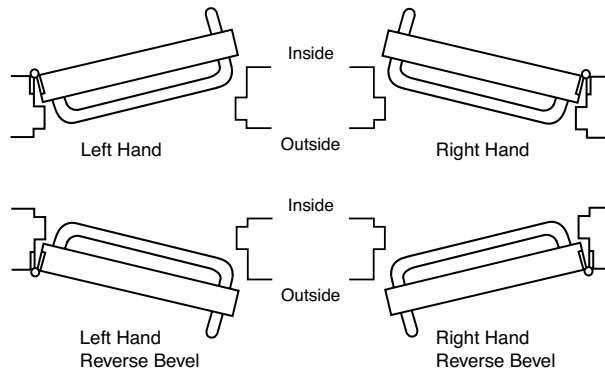

Mounting Types for Push Bars No. 10 through No. 45 and No. 50, No. 51, No. 52

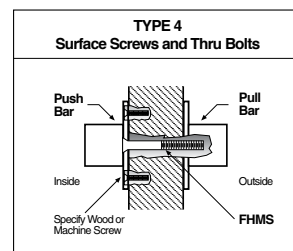
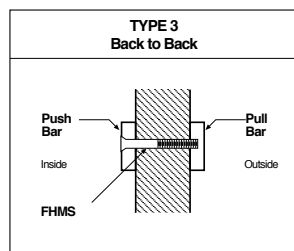
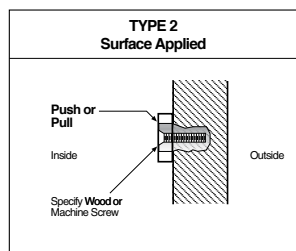
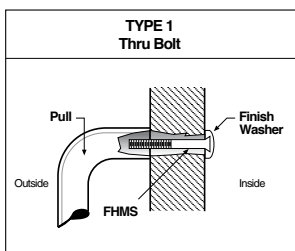



Push Bar No. 10-PB

- Material:** Brass and Bronze
- Finishes:** Available in standard architectural finishes (see page 9)
- Mounting:** Metal door: type 2, surface, #8 - 32x³/₄" OH MS
Wood door: type 2, surface, #8x³/₄" OH SMS
- Ordering:** Specify CTC, door type, mounting, and finish
- Features:** Can be field cut if necessary

No.	Material Size	Base	Projection	Clearance	Weight
10-PB	³ / ₈ " x 1 ¹ / ₂ "	1 ¹ / ₂ " x 2 ⁷ / ₈ "	1 ¹ / ₄ "	⁵ / ₈ "	6.9 lbs.



Push Bars No. 11-PB, 12-PB

- Material:** Aluminum, brass, bronze, stainless steel
- Finishes:** Available in standard architectural finishes, except US32 (see page 9)
- Mounting:** **No. 11:**
Metal door: type 2, surface, ¹/₄ - 20x1¹/₂" MS & #8 - 32x³/₄" OH MS
Wood door: type 2, surface, #12x³/₄" WS & #8x³/₄" OH SMS
- No. 12:**
Metal and wood door: type 1, ¹/₄ - 20x2¹/₄" thru bolt and finish washer (standard 1³/₄" door)
- Ordering:** Specify CTC, door type, mounting and finish
- Options:** Advise if door thickness is other than 1³/₄"

No.	Material Size	Base	Projection	Clearance	Weight
11-PB	³ / ₈ " x 1 ¹ / ₂ "	1" x 3" x ¹ / ₈ "	2"	1 ⁵ / ₈ "	6.2 lbs.
12-PB (less base plate)	³ / ₈ " x 1 ¹ / ₂ "	³ / ₈ " x 1 ¹ / ₂ "	1 ⁷ / ₈ "	1 ¹ / ₂ "	6.2 lbs.

ROCKWOOD[®]

ASSA ABLOY

Experience a safer
and more open world

800 458 2424 | www.rockwoodmfg.com
Check the web site for the up-to-date catalog

Copyright © 2012-2024, ASSA ABLOY Accessories and Door Controls Group, Inc. All rights reserved. Reproduction in whole or in part without the express written permission of ASSA ABLOY Accessories and Door Controls Group, Inc. is prohibited.



Push Bars No. 14-PB, 15-PB

- Material:** Aluminum, brass, bronze, stainless steel
- Finishes:** Available in standard architectural finishes, except US32 (see page 9)
- Mounting:** Metal and wood door: type 1, $\frac{1}{4}$ -20x $\frac{1}{4}$ " thru bolt & finish washer (standard $1\frac{3}{4}$ " door)
- Ordering:** Specify CTC, door type, mounting, and finish
- Options:** Advise if door thickness is other than $1\frac{3}{4}$ "

No.	Material Size	Base	Projection	Clearance	Weight
14-PB	$\frac{3}{8}$ " x $1\frac{1}{2}$ "	$1\frac{1}{2}$ " x 2 " x $\frac{1}{8}$ "	2"	$1\frac{5}{8}$ "	6.3 lbs.
15-PB (less base plate)	$\frac{3}{8}$ " x $1\frac{1}{2}$ "	$\frac{3}{8}$ " x $1\frac{1}{2}$ "	$1\frac{7}{8}$ "	$1\frac{1}{2}$ "	6.1 lbs.



Push Bars No. 18-PB, 19-PB

- Material:** Aluminum, brass, stainless steel, bronze
- Finishes:** Available in standard architectural finishes, except US32 (see page 9)
- Mounting:** **No. 18:**
Metal door: type 2, surface, $\frac{1}{4}$ -20x1" and #8-32x $\frac{3}{4}$ " OH MS
Wood door: type 2, surface, #12x $1\frac{1}{4}$ " FH WS and #8x $\frac{3}{4}$ " OH SMS
- No. 19:**
Metal door: type 1, thru bolt, $\frac{1}{4}$ -20x1 OH MS
Wood door: type 1, thru bolt, #12x $1\frac{1}{4}$ " FH WS, finish washer
- Ordering:** Specify CTC, door type, mounting, and finish
- Options:** Advise if door thickness is other than $1\frac{3}{4}$ "

No.	Material Size	Base	Projection	Clearance	Weight
18-PB	$\frac{3}{8}$ " x $1\frac{1}{2}$ "	1" x 3 x $\frac{1}{8}$ "	$2\frac{1}{8}$ "	$1\frac{3}{4}$ "	6.2 lbs.
19-PB (less base plate)	$\frac{3}{8}$ " x $1\frac{1}{2}$ "	$\frac{3}{8}$ " x $1\frac{1}{2}$ "	2"	$1\frac{5}{8}$ "	6.2 lbs.

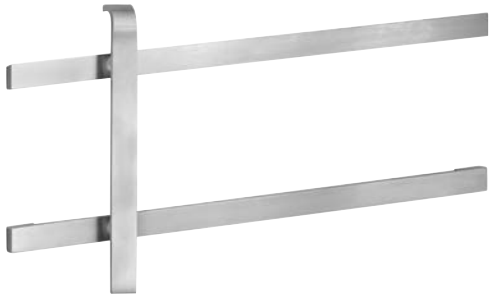

Pull Bars No. 20-PB, 21-PB

- Material:** Aluminum, brass, bronze, stainless steel
- Finishes:** Available in standard architectural finishes, except US32 (see page 9)
- Mounting:** Metal and wood door: type 1, $\frac{1}{4}$ -20 x $2\frac{1}{4}$ " thru bolt and finish washer (standard $1\frac{3}{4}$ " door)
- Ordering:** Specify CTC, door type, and finish
- Options:**
- Ideal for engraving
 - Advise if door thickness is other than $1\frac{3}{4}$ "

No.	Material Size	Base	Projection	Clearance	Space	Weight
20-PB	$\frac{3}{8}$ " x $1\frac{1}{4}$ "	$1\frac{1}{2}$ " x $1\frac{1}{4}$ "	$2\frac{1}{4}$ "	$1\frac{7}{8}$ "	8"	12.3 lbs.
21-PB	$\frac{3}{8}$ " x $1\frac{1}{2}$ "	$1\frac{1}{2}$ " x $1\frac{1}{2}$ "	$2\frac{1}{4}$ "	$1\frac{7}{8}$ "	8"	14.7 lbs.



Pull Bars No. 22-PB, 23-PB

- Material:** Aluminum, brass, bronze, stainless steel
- Finishes:** Available in standard architectural finishes, except US32 (see page 9)
- Mounting:** Metal and wood door: type 1, $\frac{1}{4}$ -20 x $2\frac{1}{4}$ " thru bolt and finish washer (standard $1\frac{3}{4}$ " door)
- Ordering:** Specify CTC, door type, and finish
- Options:** Ideal for engraving
- Other:**
- Pull length is 42" from top post to bottom post
 - Advise if door thickness is other than $1\frac{3}{4}$ "

No.	Material Size	Base	Projection	Clearance	Space	Weight
22-PB	$\frac{3}{8}$ " x $1\frac{1}{4}$ "	$1\frac{1}{2}$ " x $1\frac{1}{4}$ "	$2\frac{1}{4}$ "	$1\frac{7}{8}$ "	8"	16.7 lbs.
23-PB	$\frac{3}{8}$ " x $1\frac{1}{2}$ "	$1\frac{1}{2}$ " x $1\frac{1}{2}$ "	$2\frac{1}{4}$ "	$1\frac{7}{8}$ "	8"	20.0 lbs.

ROCKWOOD®

ASSA ABLOY

Experience a safer
and more open world

800 458 2424 | www.rockwoodmfg.com
Check the web site for the up-to-date catalog

Copyright © 2012-2024, ASSA ABLOY Accessories and Door Controls Group, Inc. All rights reserved. Reproduction in whole or in part without the express written permission of ASSA ABLOY Accessories and Door Controls Group, Inc. is prohibited.



Push Bars No. 25-PB, 26-PB

- Material:** Aluminum, brass, bronze, stainless steel
- Finishes:** Available in standard architectural finishes, except US32 (see page 9)
- Mounting:** Metal and wood door: type 1, $\frac{1}{4}$ -20 x $2\frac{1}{4}$ " thru bolt and finish washer (standard $1\frac{3}{4}$ " door)
Metal door: type 2, surface, $\frac{1}{4}$ -20 MS
Wood door: type 2, surface, #12 WS
- Ordering:** Specify CTC, door type, mounting, and finish
- Options:** Advise if door thickness is other than $1\frac{3}{4}$ "

No.	Material Size	Base	Projection	Clearance	Space	Weight
25-PB	$\frac{3}{8}$ " x $1\frac{1}{4}$ "	$1\frac{1}{2}$ " x $1\frac{1}{4}$ "	$\frac{3}{4}$ "	$\frac{3}{8}$ "	—	4.8 lbs.
26-PB	$\frac{3}{8}$ " x $1\frac{1}{2}$ "	$1\frac{1}{2}$ " x $1\frac{1}{2}$ "	$\frac{3}{4}$ "	$\frac{3}{8}$ "	—	5.8 lbs.

Push & Pull Bar Sets No. 27-PB, 28-PB, 29-PB, 30-PB

- Material:** Aluminum, brass, bronze, stainless steel
- Finishes:** Available in standard architectural finishes, except US32 (see page 9)
- Mounting:** Metal and wood door: type 3, back to back, $\frac{1}{4}$ -20 MS
- Ordering:** Specify CTC, door type, and finish

No.	Material Size	Space	Weight
27-PB	Set consists of 1 #20-PB and 2 #25-PB	8"	21.9 lbs.
28-PB	Set consists of 1 #21-PB and 2 #26-PB	8"	26.3 lbs.
29-PB	Set consists of 1 #22-PB and 2 #25-PB	8"	26.3 lbs.
30-PB	Set consists of 1 #23-PB and 2 #26-PB	8"	31.6 lbs.

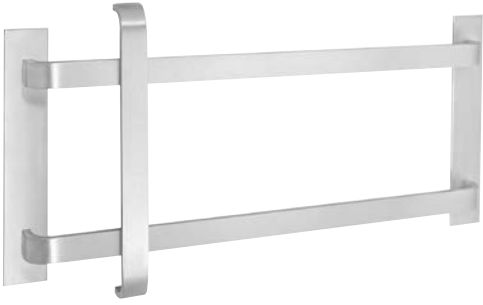

Pull Bars No. 31-PB, 32-PB

- Material:** Aluminum, brass, bronze, stainless steel
- Finishes:** Available in standard architectural finishes, except US32 (see page 9)
- Mounting:** Metal and wood door: type 1, thru bolt, 1/4" - 20 x 2 1/4" FH MS, finish washers (standard 1 3/4" door)
- Ordering:** Specify CTC, door type, and finish
- Options:**
- Ideal for engraving
 - Advise if door thickness is other than 1 3/4"

No.	Material Size	Base	Projection	Clearance	Space	Weight
31-PB	3/8" x 1 1/4"	2" x 12" x 1/8"	2"	1 5/8"	8"	12.8 lbs.
32-PB	3/8" x 1 1/2"	2" x 12" x 1/8"	2"	1 5/8"	8"	15.4 lbs.

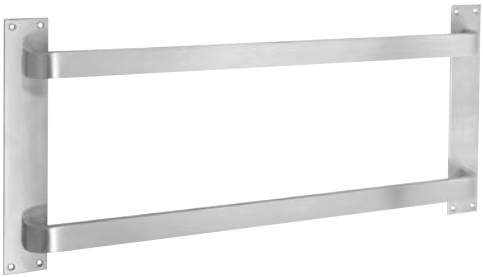

Push Bars No. 33-PB, 34-PB

- Material:** Aluminum, brass, bronze, stainless steel
- Finishes:** Available in standard architectural finishes, except US32 (see page 9)
- Mounting:** Metal door: type 2, surface, #8 - 32 x 3/4" OH MS
Wood door: type 2, surface, #8 x 3/4" OH SMS
- Ordering:** Specify CTC, door type, mounting, and finish
- Options:** Ideal for engraving

No.	Material Size	Base	Projection	Clearance	Space	Weight
33-PB	3/8" x 1 1/4"	2" x 12" x 1/8"	1 5/8"	1 1/4"	8"	10.9 lbs.
34-PB	3/8" x 1 1/2"	2" x 12" x 1/8"	1 5/8"	1 1/4"	8"	13.1 lbs.

Push and Pull Bar Sets No. 35-PB, 36-PB

- Material:** Aluminum, brass, stainless steel, bronze
- Finishes:** Available in standard architectural finishes, except US32 (see page 9)
- Mounting:** Metal door: type 4, back to back, 1/4" - 20 x 2 1/4" & #8 - 32 x 3/4" OH MS
Wood door: type 4, back to back, 1/4" - 20 x 2 1/4" & #8 x 3/4" OH SMS
- Ordering:** Specify CTC, door type, mounting, and finish

No.	Material Size	Space	Weight
35-PB	Set consists of 1 #31-PB & 1 #33-PB	8"	23.7 lbs.
36-PB	Set consists of 1 #32-PB & 1 #34-PB	8"	28.5 lbs.

ROCKWOOD[®]

ASSA ABLOY

Experience a safer
and more open world

800 458 2424 | www.rockwoodmfg.com
Check the web site for the up-to-date catalog

Copyright © 2012-2024, ASSA ABLOY Accessories and Door Controls Group, Inc. All rights reserved. Reproduction in whole or in part without the express written permission of ASSA ABLOY Accessories and Door Controls Group, Inc. is prohibited.

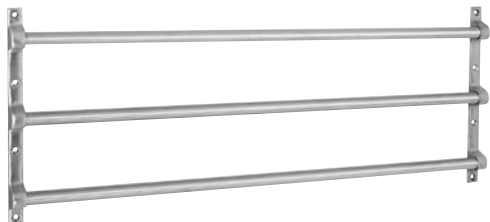

Screen Door Guard No. 40-PB

- Material:** Brass and Bronze
- Finishes:** Available in standard architectural finishes (see page 9)
- Mounting:** Metal door: type 2, surface, #8 - 32x³/₄" OH MS
Wood door: type 2, surface, #8x³/₄" OH SMS
- Ordering:** Specify CTC, door type, mounting, and finish

No.	Material Size	Base	Projection	Clearance	Bar Space	Weight
40-PB	⁵ / ₈ " tube	⁵ / ₈ " x 9 ⁵ / ₈ "	1 ¹ / ₈ "	³ / ₈ "	3 ¹ / ₂ "	4.5 lbs.



Screen Door Guard No. 41-PB

- Material:** Brass and Bronze
- Finishes:** Available in standard architectural finishes (see page 9)
- Mounting:** Metal door: type 2, surface, #8 - 32x³/₄" OH MS
Wood door: type 2, surface, #8x³/₄" OH SMS
- Ordering:** Specify CTC, door type, mounting, and finish

No.	Material Size	Base	Projection	Clearance	Bar Space	Weight
41-PB	⁵ / ₈ " tube	⁵ / ₈ " x 6 ¹ / ₈ "	1 ¹ / ₈ "	³ / ₈ "	3 ¹ / ₂ "	2.9 lbs.



Screen Door Guard No. 42-PB

- Material:** Brass and Bronze
- Finishes:** Available in standard architectural finishes (see page 9)
- Mounting:** Metal door: type 2, surface, #8 - 32x³/₄" OH MS
Wood door: type 2, surface, #8x³/₄" OH SMS
- Ordering:** Specify CTC, door type, mounting, and finish

No.	Material Size	Base	Projection	Clearance	Bar Space	Weight
42-PB	⁵ / ₈ " tube	⁵ / ₈ " x 2 ⁵ / ₈ "	1 ¹ / ₈ "	³ / ₈ "	—	1.6 lbs.



Push Bars No. 43-PB, 44-PB

- Material:** Aluminum, brass, bronze, stainless steel
- Finishes:** Available in standard architectural finishes, except US32 (see page 9)
- Mounting:** Metal and wood door: type 1, $\frac{1}{4}$ -20x $\frac{1}{4}$ " thru bolt and finish washer (standard $1\frac{3}{4}$ " door)
- Ordering:** Specify CTC, door type, mounting, and finish
- Other:** Ideal for engraving or logos
- Options:** Advise if door thickness is other than $1\frac{3}{4}$ "

No.	CTC	Material Size	Base	Projection	Clearance	Weight
43-PB	Specify	$\frac{3}{8}$ " x 3"	$1\frac{1}{2}$ " x $4\frac{1}{2}$ " x $\frac{1}{8}$ "	2"	$1\frac{5}{8}$ "	10.5 lbs.
44-PB (less base plate)	Specify	$\frac{3}{8}$ " x 3"	—	$1\frac{7}{8}$ "	$1\frac{1}{2}$ "	10.1 lbs.



Push Bar No. 45-PB

- Material:** Aluminum, brass, bronze, stainless steel
- Finishes:** Available in standard architectural finishes, except US32 (see page 9)
- Mounting:** Metal and wood door: type 1, $\frac{1}{4}$ -20x $\frac{1}{4}$ " thru bolt and finish washer (standard $1\frac{3}{4}$ " door)
- Ordering:** Specify CTC, door type, mounting, and finish
- Other:** Ideal for engraving or logos
- Options:** Advise if door thickness is other than $1\frac{3}{4}$ "

No.	CTC	Material Size	Base	Projection	Clearance	Weight
45-PB	Specify	$\frac{3}{8}$ " x 3"	$1\frac{1}{2}$ " x 3"	$\frac{3}{4}$ "	$\frac{3}{8}$ "	9.9 lbs.

ROCKWOOD[®]

ASSA ABLOY

Experience a safer
and more open world

800 458 2424 | www.rockwoodmfg.com
Check the web site for the up-to-date catalog

Copyright © 2012-2024, ASSA ABLOY Accessories and Door Controls Group, Inc. All rights reserved. Reproduction in whole or in part without the express written permission of ASSA ABLOY Accessories and Door Controls Group, Inc. is prohibited.

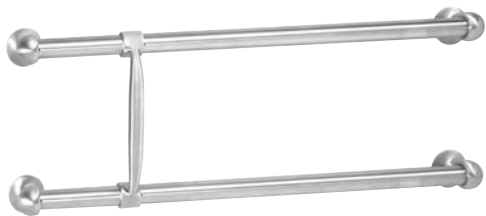

Pull Bar No. 50-PB

- Material:** Brass, bronze
- Finishes:** Available in standard architectural finishes (see page 9)
- Mounting:** Metal and wood door: type 1, $\frac{1}{4}$ - 20 x $2\frac{1}{4}$ " thru bolt & finish washer (standard $1\frac{3}{4}$ " door)
Wood door: type 2 surface, #8 x $\frac{3}{4}$ " OH SMS
- Ordering:** Specify CTC, door type, and finish
- Other:** Cast slip-on end brackets
- Options:** Advise if door thickness is other than $1\frac{3}{4}$ "

No.	Material Size	Base	Projection	Clearance	Space	Weight
50-PB	1" dia.	2" dia.	$3\frac{1}{8}$ "	$2\frac{5}{8}$ "	$7\frac{1}{2}$ "	7.6 lbs.



Push Bar and Door Pull No. 51-PB, 53-PB

- Material:** Brass, bronze
- Finishes:** Available in standard architectural finishes (see page 9)
- Mounting:** Metal and wood door: type 1, thru bolt, $\frac{1}{4}$ - 20 x $2\frac{1}{4}$ " MS, finish washers (standard $1\frac{3}{4}$ " door)
Metal door: type 2, surface, #8 - 32 x $\frac{3}{4}$ " OH MS
Wood door: type 2, surface, #8 x $\frac{3}{4}$ " OH SMS
- Ordering:** Specify CTC, door type, mounting, and finish
- Other:** Cast slip-on end brackets
- Options:** Advise if door thickness is other than $1\frac{3}{4}$ "

No.	Material Size	CTC	Base	Projection	Clearance	Weight
51-PB	1" dia.	Specify	2" dia.	$2\frac{3}{8}$ "	$1\frac{1}{4}$ "	3.1 lbs.
53-PB	1" dia.	12"	2" dia.	$2\frac{3}{8}$ "	$1\frac{1}{4}$ "	1.5 lbs.

Push and Pull Bar Set No. 52-PB

- Material:** Brass, bronze
- Finishes:** Available in standard architectural finishes (see page 9)
- Mounting:** Metal door: type 4, back to back, $\frac{1}{4}$ - 20 x $2\frac{1}{4}$ " MS and #8 - 32 x $\frac{3}{4}$ " OH MS
Wood door: type 4, back to back, $\frac{1}{4}$ - 20 x $2\frac{1}{4}$ " MS and #8 x $\frac{3}{4}$ " OH SMS
- Ordering:** Specify CTC, door type, mounting, and finish
- Other:** Cast slip-on end brackets

No.	Material Size	Weight
52-PB	Set consists of 1 #50-PB and 2 #51-PB	30.9 lbs.

Typical Mounting

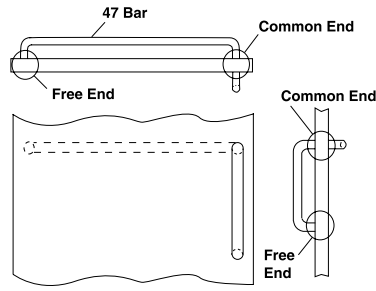

Free End Details

Thru Bolt

Wood or Metal Door - Type 1

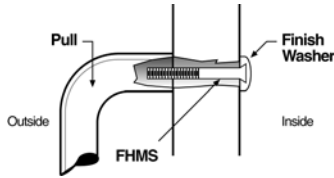

Type	Bolt Size	Drill Size	
		Wood	Metal
1	1/4 - 20	9/32	9/32
1HD	5/16 - 18	11/32	11/32
1XHD	3/8 - 16	13/32	13/32

Wood or Metal Door - Type 12

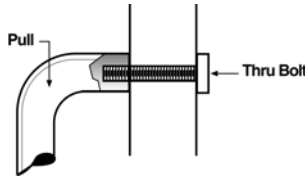

Type	Bolt Size	Drill Size	
		Wood	Metal
12	1/4 - 20	9/32	9/32
12HD	5/16 - 18	11/32	11/32
12XHD	3/8 - 16	13/32	13/32

Glass Door - Type 15

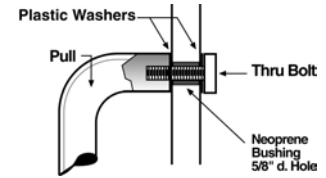

Type	Bolt Size	Drill Size - Glass
15	1/4 - 20	5/8
15HD	5/16 - 18	5/8
15XHD	3/8 - 16	5/8

Surface Concealed

Metal Door - Type 6

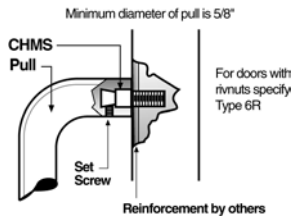

Type	Bolt Size	Drill Size - Metal
6	1/4 - 20	1/4 - 20 tap
6HD	5/16 - 18	5/16 - 18 tap

Wood Door - Type 8

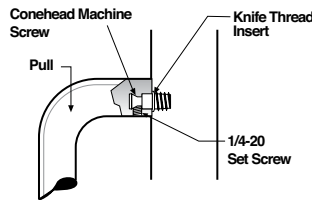

Type	Bolt Size	Drill Size - Wood
8	1/4 - 20	23/64 X 9/16 dp
8HD	5/16 - 18	7/16 X 9/16 dp

Metal Door - Type 17

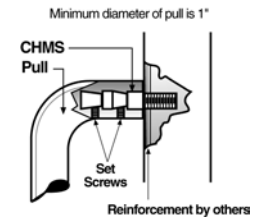

Type	Bolt Size	Drill Size - Metal
17	1/4 - 20	1/4 - 20 tap
17HD	5/16 - 18	5/16 - 18 tap

Common End Details

Wood or Metal Door - Type 5

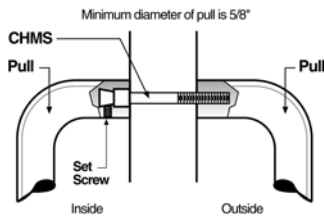

Type	Bolt Size	Drill Size	
		Wood	Metal
5	1/4 - 20	9/32	9/32
5HD	5/16 - 18	11/32	11/32

Glass Door - Type 13

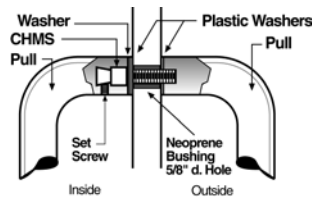

Type	Bolt Size	Drill Size - Glass
13	1/4 - 20	5/8
13HD	5/16 - 18	5/8

NOTE: Heavy Duty (HD/XHD) mounting features hex drive for positive tightening and large overall size for superior strength. Recommended for high frequency and rough service openings.

ROCKWOOD

ASSA ABLOY

Experience a safer and more open world

800 458 2424 | www.rockwoodmfg.com
Check the web site for the up-to-date catalog

Copyright © 2012-2024, ASSA ABLOY Accessories and Door Controls Group, Inc. All rights reserved. Reproduction in whole or in part without the express written permission of ASSA ABLOY Accessories and Door Controls Group, Inc. is prohibited.



Series 47 Push Bar No. SP47

- Material:** Aluminum, brass, bronze, stainless steel
- Finishes:** Available in standard architectural finishes; US32DMS, US32D316, US32316, white (WPC), red (RPC), and black (BPC) powder coat finishes (see page 9)
- Mounting:** Metal and wood door: type 1, $\frac{1}{4}$ - 20 x $2\frac{1}{4}$ " thru bolt and finish washer (standard $1\frac{3}{4}$ " door)
NOTE: See page A10 for detailed mounting drawings
- Ordering:** Specify CTC, handing, door type, and finish
- Options:**
- Engraving "PUSH" or "PULL"
 - Advise if door thickness is other than $1\frac{3}{4}$ "

No.	CTC	Material Size	Base	Projection	Clearance	Weight
SP47	Specify	1" dia.	1" dia.	$2\frac{3}{4}$ "	$1\frac{1}{2}$ "	8.5 lbs.



Series 47 Push Bar No. 47-PB, 47-2-PB, 47-3-PB, 48-PB



- Material:** Aluminum, brass, bronze, stainless steel
- Finishes:** Available in standard architectural finishes, US32DMS, US32D316, US32316, white (WPC), red (RPC), and black (BPC) powder coat finishes (see page 9)
- Mounting:**
- No. 47, 47-2, 47-3:**
Metal and wood door: type 1, $\frac{1}{4}$ - 20 x $2\frac{1}{4}$ " thru bolt and finish washer (standard $1\frac{3}{4}$ " door)
Metal door: type 6, concealed, $\frac{1}{4}$ - 20 CH MS
- No. 48 (not shown):**
Metal and wood door: type 1, $\frac{1}{4}$ - 20 x $2\frac{1}{4}$ " thru bolt and finish washer (standard $1\frac{3}{4}$ " door)
NOTE: See page A10 for detailed mounting drawings
- Ordering:** Specify CTC, door type, mounting, and finish
- Options:**
- Engraving "PUSH" or "PULL". Specify handing
 - Heavy duty versions of most fastening types available – use suffix HD to fastening type number (47 Type 6HD)
 - Advise if door thickness is other than $1\frac{3}{4}$ "

PUSH

Engraved

No.	CTC	Material Size	Base	Projection	Clearance	Weight
47-PB	Specify	1" dia.	1" dia.	$2\frac{3}{4}$ "	$1\frac{3}{4}$ "	8.5 lbs.
47-2-PB	Specify	1" dia.	1" dia.	$2\frac{3}{4}$ "	$1\frac{3}{4}$ "	17.0 lbs.
47-3-PB	Specify	1" dia.	1" dia.	$2\frac{3}{4}$ "	$1\frac{3}{4}$ "	25.5 lbs.
48-PB	Specify	$\frac{3}{4}$ " dia.	$\frac{3}{4}$ " dia.	$2\frac{3}{4}$ "	$1\frac{3}{4}$ "	4.5 lbs.

ROCKWOOD®

ASSA ABLOY

Experience a safer
and more open world



49-PB

Series 49 Push Bar No. 49-PB with Santoprene grip

- Material:** Aluminum
- Finishes:** Available in US28, 313, 314, 315, 10BE, BSP (Black Suede), WSP (White Suede), stock powder coat finishes (see page 9)
- Mounting:**
- Metal and wood door: type 1, 1/4"-20 x 2 1/4" thru bolt and finish washer (standard 1 3/4" door)
 - Metal and wood door: type 5 back-to-back, 1/4"-20 x 2 1/4" cone head machine screws
 - Metal door: type 6, concealed, 1/4"-20 Cone Head Machine Screws
 - Glass door: type 13, back-to-back, 1/4"-20 x 1 1/8" conehead machine screws and finish washer
- Features:** Santoprene™ durable weather resistant grip
- Options:** Heavy duty versions of most fastening types available - use suffix HD to fastening type number (49 Type 6HD)
Advise if door thickness is other than 1 3/4"
See page B13 for mounting selection (standard duty 1/4" - 20)

No.	CTC	Material Size	Base	Projection	Clearance	Weight
49-PB	Specify	1" dia.	1" dia.	2 3/4"	1 3/4"	9.5 lbs.



No. BP47



No. BP47-2

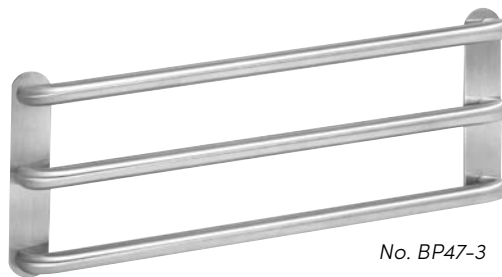

No. BP47-3

Series 47 Push Bar No. BP47, BP47-2, BP47-3

- Material:** Aluminum, brass, bronze, stainless steel
- Finishes:** Available in standard architectural finishes, US32DMS, US32D316, US32316, white (WPC), red (RPC), and black (BPC) powder coat finishes (see page 9)
- Mounting:**
- No. BP47:**
Metal and wood door: type 1, 1/4 - 20x2 1/4" thru bolt and finish washer (standard 1 3/4" door)
Metal door: type 6, concealed, 1/4 - 20 CH MS x 1/2" thread
- No. BP47-2, BP47-3:**
Metal and wood door: type 1, 1/4 - 20x2 1/4" thru bolt and finish washer (standard 1 3/4" door)
Metal door: type 2, surface, #8 - 32x 3/4" OH MS
Wood door: type 2, surface, #8 x 3/4" OH SMS
Metal door: type 6, concealed, 1/4 - 20 CH MS x 1/2" thread
NOTE: See page A10 for detailed mounting drawings
- Ordering:** Specify CTC, door type, mounting and finish.
- Options:**
- Engraving "PUSH" or "PULL". Specify handing
 - Heavy duty versions of most fastening types available - use suffix HD to fastening type number (BP47 Type 6HD)
 - Advise if door thickness is other than 1 3/4"

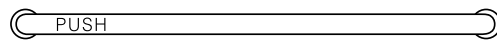

Engraved

No.	CTC	Material Size	Base	Projection	Clearance	Weight
BP47	Specify	1" dia.	1 1/4" dia.	2 7/8"	1 7/8"	9.0 lbs.
BP47-2	Specify	1" dia.	2" x 6"	2 7/8"	1 7/8"	18.0 lbs.
BP47-3	Specify	1" dia.	2" x 10"	2 7/8"	1 7/8"	27.5 lbs.

ROCKWOOD®

ASSA ABLOY

Experience a safer and more open world

800 458 2424 | www.rockwoodmfg.com
Check the web site for the up-to-date catalog

Copyright © 2012-2024, ASSA ABLOY Accessories and Door Controls Group, Inc. All rights reserved. Reproduction in whole or in part without the express written permission of ASSA ABLOY Accessories and Door Controls Group, Inc. is prohibited.

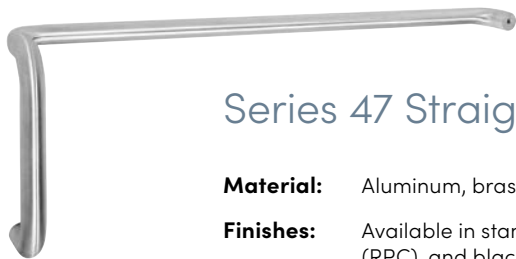

Series 47 Straight Single Bar Sets

Material: Aluminum, brass, bronze, stainless steel

Finishes: Available in standard architectural finishes, US32D**M**S, US32D**316**, US32**316**, white (WPC), red (RPC), and black (BPC) powder coat finishes (see page 9).

Mounting:	Door	Pull Free End	Push Free End	Common End	Description	Mounting Spec. No.
	Metal & wood	1	1	5	Back to back & thru bolt	T3**
	Metal	6	6	5	Back to back & concealed	T4
	Wood	8	8	5	Back to back & concealed	T5
	Metal & wood	12	12	5	Back to back & decorative bolt	T1
	Glass	15	15	13	Back to back & thru bolt	T2

** T3 is the standard mounting method for metal and wood doors.

NOTE: See page A10 for detailed mounting drawings

Ordering: Specify product number, mounting, door type, push bar CTC, and finish (11247 T3, wood door, 33" CTC, US32D**316**)

Other: See page A1 on "How To" size push bars

- Options:**
- Engraving "PUSH" or "PULL". Specify handing
 - Base plates available similar to those shown on page A12 — use BP prefix (BP11047) when ordering
 - Heavy duty versions of most fastening types available — use suffix HD to fastening type number (11047 T3HD)

NOTE: Pull bar Projection : 3-1/2" for Stainless Steel and 3" for Aluminum, Brass and Bronze.



No.	Material Size	Pull			Push		Weight
		CTC	Projection	Clearance	Projection	Clearance	
11047	1" dia.	8"	3 1/2"	2"	2 3/4"	1 3/4"	11.5 lbs.
111A47	1" dia.	9"	3 1/2"	2"	2 3/4"	1 3/4"	11.7 lbs.
11147	1" dia.	10"	3 1/2"	2"	2 3/4"	1 3/4"	12.0 lbs.
11247	1" dia.	12"	3 1/2"	2"	2 3/4"	1 3/4"	12.5 lbs.
11847	1" dia.	18"	3 1/2"	2"	2 3/4"	1 3/4"	14.0 lbs.

Pull projection is 3 1/2" for stainless steel and 3" for aluminum, brass and bronze.

800 458 2424 | www.rockwoodmfg.com
Check the web site for the up-to-date catalog

Copyright © 2012-2024, ASSA ABLOY Accessories and Door Controls Group, Inc. All rights reserved. Reproduction in whole or in part without the express written permission of ASSA ABLOY Accessories and Door Controls Group, Inc. is prohibited.

ROCKWOOD®
ASSA ABLOY

Experience a safer
and more open world

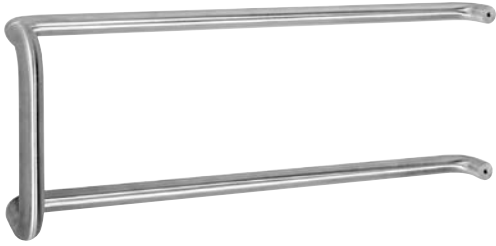

Series 47 Straight Double Bar Sets

Material: Aluminum, brass, bronze, stainless steel

Finishes: Available in standard architectural finishes, US32DMS, US32D316, US32316, white (WPC), red (RPC), and black (BPC) powder coat finishes (see page 9).

Mounting:	Door	Push Free End	Common End	Description	Mounting Spec. No.
	Metal & wood	1	5	Back to back & thru bolt	T3**
	Metal	6	5	Back to back & concealed	T4
	Wood	8	5	Back to back & concealed	T5
	Metal & wood	12	5	Back to back & decorative bolt	T1
	Glass	15	13	Back to back & thru bolt	T2

** T3 is the standard mounting method for metal and wood doors.

NOTE: See page A10 for detailed mounting drawings.

Ordering: Specify product number, mounting, door type, push bar CTC, and finish (11247-2 T3, wood door, 33" CTC, US32D316)

Other: See page A1 on "How To" size push bars

Options:

- Engraving "PUSH" or "PULL". Specify handing
- Base plates available similar to those shown on page A12 – use BP prefix (BP11047-2) when ordering
- Heavy duty versions of most fastening types available – use suffix HD to fastening type number (11047-2 T3HD)

NOTE: Pull bar Projection : 3-1/2" for Stainless Steel and 3" for Aluminum, Brass and Bronze.

No.	Material Size	Pull			Push		Weight
		CTC	Projection	Clearance	Projection	Clearance	
11047-2	1" dia.	8"	3"	2"	2 ³ / ₄ "	1 ³ / ₄ "	20.0 lbs.
111A47-2	1" dia.	9"	3"	2"	2 ³ / ₄ "	1 ³ / ₄ "	20.2 lbs.
11147-2	1" dia.	10"	3"	2"	2 ³ / ₄ "	1 ³ / ₄ "	20.5 lbs.
11247-2	1" dia.	12"	3"	2"	2 ³ / ₄ "	1 ³ / ₄ "	21.0 lbs.

ROCKWOOD®

ASSA ABLOY

Experience a safer
and more open world

800 458 2424 | www.rockwoodmfg.com
Check the web site for the up-to-date catalog

Copyright © 2012-2024, ASSA ABLOY Accessories and Door Controls Group, Inc. All rights reserved. Reproduction in whole or in part without the express written permission of ASSA ABLOY Accessories and Door Controls Group, Inc. is prohibited.



Series 47 Straight Triple Bar Sets

Material: Aluminum, brass, bronze, stainless steel

Finishes: Available in standard architectural finishes, US32DMS, US32D316, US32316, white (WPC), red (RPC), and black (BPC) powder coat finishes (see page 9).

Mounting:	Door	Push Free End	Common End	Description	Mounting Spec. No.
	Metal & wood	1	5	Back to back & thru bolt	T3**
	Metal	6	5	Back to back & concealed	T4
	Wood	8	5	Back to back & concealed	T5
	Metal & wood	12	5	Back to back & decorative bolt	T1
	Glass	15	13	Back to back & thru bolt	T2

** T3 is the standard mounting method for metal and wood doors.

NOTE: See page A10 for detailed mounting drawings

Ordering: Specify product number, mounting, door type, push bar CTC, and finish (11247-3 T3, wood door, 33" CTC, US32D316)

Other: See page A1 on "How To" size push bars

Options:

- Engraving "PUSH" or "PULL". Specify handing
- Base plates available similar to those shown on page A12 – use BP prefix (BP11047-3) when ordering
- Heavy duty versions of most fastening types available – use suffix HD to fastening type number (11047-3 T3HD)

NOTE: Pull bar Projection : 3-1/2" for Stainless Steel and 3" for Aluminum, Brass and Bronze.

No.	Material Size	Pull			Push		Weight
		CTC	Projection	Clearance	Projection	Clearance	
11047-3	1" dia.	8"	3"	2"	2 ³ / ₄ "	1 ³ / ₄ "	28.5 lbs.
111A47-3	1" dia.	9"	3"	2"	2 ³ / ₄ "	1 ³ / ₄ "	28.7 lbs.
11147-3	1" dia.	10"	3"	2"	2 ³ / ₄ "	1 ³ / ₄ "	29.0 lbs.
11247-3	1" dia.	12"	3"	2"	2 ³ / ₄ "	1 ³ / ₄ "	29.5 lbs.



Series 47 Offset Single Bar Sets

Material: Aluminum, brass, bronze, stainless steel

Finishes: Available in standard architectural finishes, US32D**MS**, US32D**316**, US32**316**, white (WPC), red (RPC), and black (BPC) powder coat finishes (see page 9).

Mounting:	Door	Pull Free End	Push Free End	Common End	Description	Mounting Spec. No.
	Metal & wood	1	1	5	Back to back & thru bolt	T3**
	Metal	17	17	16	Back to back & concealed	T4
	Wood	8	8	5	Back to back & concealed	T5
	Metal & wood	12	12	5	Back to back & decorative bolt	T1
	Glass	15	15	13	Back to back & thru bolt	T2

** T3 is the standard mounting method for metal and wood doors.

NOTE: See page A10 for detailed mounting drawings

Ordering: Specify product number, mounting, door type, push bar CTC, and finish (BF15747 T3, wood door, 33" CTC, US32D**316**)

Other: See page A1 on "How To" size push bars

Options:

- Engraving "PUSH" or "PULL". Specify handing
- Base plates available similar to those shown on page A12 – use BP prefix (BPBF15747) when ordering
- Heavy duty versions of most fastening types available – use suffix HD to fastening type number (BF15647 T3HD)

No.	Material Size	Pull			Push		Weight
		CTC	Projection	Clearance	Projection	Clearance	
BF15647	1" dia.	8"	3½"	2½"	2¾"	1¾"	12.4 lbs.
BF157A47	1" dia.	9"	3½"	2½"	2¾"	1¾"	12.6 lbs.
BF15747	1" dia.	10"	3½"	2½"	2¾"	1¾"	12.8 lbs.
BF15847	1" dia.	12"	3½"	2½"	2¾"	1¾"	13.3 lbs.
BF15947	1" dia.	18"	3½"	2½"	2¾"	1¾"	15.0 lbs.

ROCKWOOD®

ASSA ABLOY

Experience a safer
and more open world

800 458 2424 | www.rockwoodmfg.com
Check the web site for the up-to-date catalog

Copyright © 2012–2024, ASSA ABLOY Accessories and Door Controls Group, Inc. All rights reserved. Reproduction in whole or in part without the express written permission of ASSA ABLOY Accessories and Door Controls Group, Inc. is prohibited.

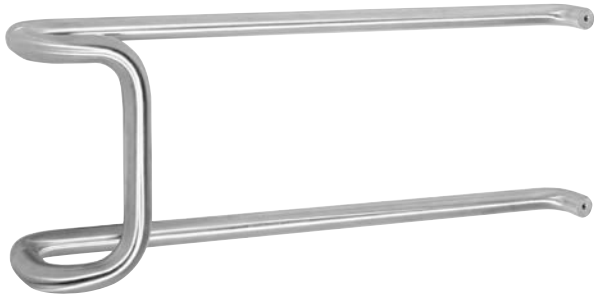

Series 47 Offset Double Bar Sets

Material: Aluminum, brass, bronze, stainless steel

Finishes: Available in standard architectural finishes, US32D**MS**, US32D**316**, US32**316**, white (WPC), red (RPC), and black (BPC) powder coat finishes (see page 9).

Mounting:	Door	Push Free End	Common End	Description	Mounting Spec. No.
	Metal & wood	1	5	Back to back & thru bolt	T3**
	Metal	17	16	Back to back & concealed	T4
	Wood	8	5	Back to back & concealed	T5
	Metal & wood	12	5	Back to back & decorative bolt	T1
	Glass	15	13	Back to back & thru bolt	T2

** T3 is the standard mounting method for metal and wood doors.

NOTE: See page A10 for detailed mounting drawings

Ordering: Specify product number, mounting, door type, push bar CTC, and finish (BF15747-2 T3, wood door, 33" CTC, US32D**316**)

Other: See page A1 on "How To" size push bars

Options:

- Engraving "PUSH" or "PULL". Specify handing
- Base plates available similar to those shown on page A12 – use BP prefix (BPBF15747-2) when ordering
- Heavy duty versions of most fastening types available – use suffix HD to fastening type number (BF15647-2 T3HD)

No.	Material Size	Pull			Push		Weight
		CTC	Projection	Clearance	Projection	Clearance	
BF15647-2	1" dia.	8"	3½"	2½"	2¾"	1¾"	20.9 lbs.
BF157A47-2	1" dia.	9"	3½"	2½"	2¾"	1¾"	21.1 lbs.
BF15747-2	1" dia.	10"	3½"	2½"	2¾"	1¾"	21.3 lbs.
BF15847-2	1" dia.	12"	3½"	2½"	2¾"	1¾"	21.8 lbs.

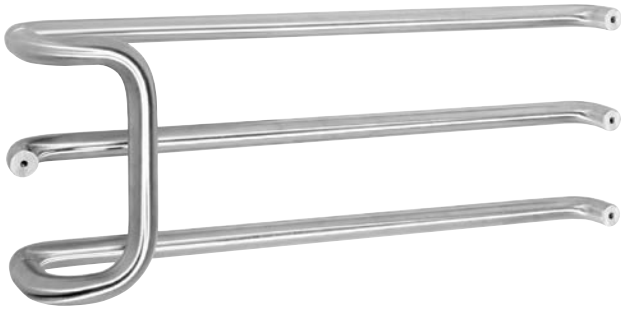

Series 47 Offset Triple Bar Sets

Material: Aluminum, brass, bronze, stainless steel

Finishes: Available in standard architectural finishes, US32DMS, US32D316, US32316, white (WPC), red (RPC), and black (BPC) powder coat finishes (see page 9).

Mounting:	Door	Push Free End	Common End	Description	Mounting Spec. No.
	Metal & wood	1	5	Back to back & thru bolt	T3**
	Metal	17	16	Back to back & concealed	T4
	Wood	8	5	Back to back & concealed	T5
	Metal & wood	12	5	Back to back & decorative bolt	T1
	Glass	15	13	Back to back & thru bolt	T2

** T3 is the standard mounting method for metal and wood doors.

NOTE: See page A10 for detailed mounting drawings

Ordering: Specify product number, mounting, door type, push bar CTC, and finish (BF15747-3 T3, wood door, 33" CTC, US32D316)

Other: See page A1 on "How To" size push bars

Options:

- Engraving "PUSH" or "PULL". Specify handing
- Base plates available similar to those shown on page A12 – use BP prefix (BPBF15747-3) when ordering
- Heavy duty versions of most fastening types available – use suffix HD to fastening type number (BF15647-3 T3HD)

No.	Material Size	Pull			Push		Weight
		CTC	Projection	Clearance	Projection	Clearance	
BF15647-3	1" dia.	8"	3½"	2½"	2¾"	1¾"	29.4 lbs.
BF157A47-3	1" dia.	9"	3½"	2½"	2¾"	1¾"	29.6 lbs.
BF15747-3	1" dia.	10"	3½"	2½"	2¾"	1¾"	29.8 lbs.
BF15847-3	1" dia.	12"	3½"	2½"	2¾"	1¾"	30.3 lbs.

ROCKWOOD®

ASSA ABLOY

Experience a safer
and more open world

800 458 2424 | www.rockwoodmfg.com
Check the web site for the up-to-date catalog

Copyright © 2012–2024, ASSA ABLOY Accessories and Door Controls Group, Inc. All rights reserved. Reproduction in whole or in part without the express written permission of ASSA ABLOY Accessories and Door Controls Group, Inc. is prohibited.

T Series 1" Tubular Push Bars and Push & Pull Bar Sets

The Rockwood T Series 1" diameter tubular push and pull bar sets are made from sturdy .065" thick wall tubing. Solid brass or stainless steel inserts are brazed into the ends to provide a solid area for our guaranteed mounting systems.

Benefits of specifying the T Series push and pulls include:

- Tubular pulls weigh 25% less than their solid counterparts; this 75% weight reduction greatly reduces the environmental impact of harvesting material for their manufacture – a LEED certified building goal
- The lighter weight minimizes the risk of damage in shipping and handling
- The cost of most tubular pulls represents a significant savings over the equivalent solid model

Considering all the benefits, the T Series pulls offer an improved value without any quality sacrifice.

T Series is also available in straight pulls (see page B15) and offset pulls (see page B29).

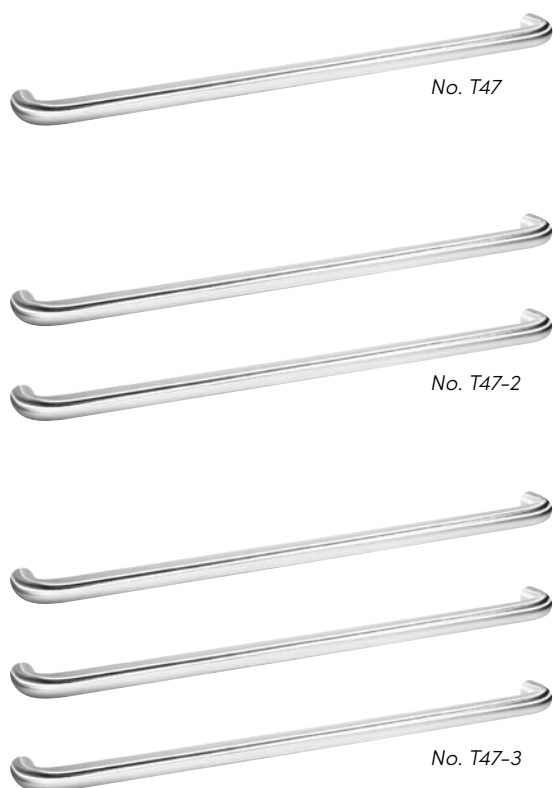

T47 Series Tubular Push Bars No. T47, T47-2, T47-3

- Material:** Brass, bronze, stainless steel
- Finishes:** Available in standard architectural finishes (see page 9)
- Mounting:** Metal and wood door: type 1, 1/4" - 20 x 2 1/4" thru bolt and finish washer (standard 1 3/4" door)
Metal door: type 6, concealed, 1/4" - 20 CH MS
NOTE: See page A10 for detailed mounting drawings
- Ordering:** Specify CTC, door type, mounting, and finish (Specify Handing)
- Options:**
- Engraving "PUSH" or "PULL"
 - Advise if door thickness is other than 1 3/4"

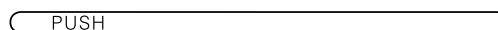

Engraved

No.	CTC	Material Size	Base	Projection	Clearance	Weight
T47	Specify	1" dia.	1" dia.	2 3/4"	1 3/4"	2.9 lbs.
T47-2	Specify	1" dia.	1" dia.	2 3/4"	1 3/4"	5.8 lbs.
T47-3	Specify	1" dia.	1" dia.	2 3/4"	1 3/4"	8.7 lbs.



T47 Series Straight Tubular Single Bar Sets

Material: Brass, bronze, stainless steel

Finishes: Available in standard architectural finishes (see page 9)

Mounting:	Door	Pull Free End	Push Free End	Common End	Description	Mounting Spec. No.
	Metal & wood	1	1	5	Back to back & thru bolt	T3**
	Metal	6	6	5	Back to back & concealed	T4
	Wood	8	8	5	Back to back & concealed	T5
	Metal & wood	12	12	5	Back to back & decorative bolt	T1
	Glass	15	15	13	Back to back & thru bolt	T2

**T3 is the standard mounting method for metal and wood doors.

NOTE: See page A10 for detailed mounting drawings

Ordering: Specify product number, mounting, door type, push bar CTC, and finish (T11247 T3, wood door, 33" CTC, US32D)

Other: See page A1 on "How To" size push bars

Options:

- Engraving "PUSH" or "PULL". Specify handing
- Base plates available similar to those shown on page A12 – use BP prefix (TBP11047) when ordering

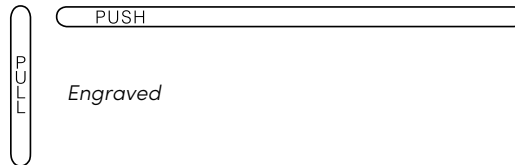

No.	Material Size	Pull			Push		Weight
		CTC	Projection	Clearance	Projection	Clearance	
T11047	1" dia.	8"	3"	2"	2 ³ / ₄ "	1 ³ / ₄ "	3.9 lbs.
T111A47	1" dia.	9"	3"	2"	2 ³ / ₄ "	1 ³ / ₄ "	4.0 lbs.
T11147	1" dia.	10"	3"	2"	2 ³ / ₄ "	1 ³ / ₄ "	4.0 lbs.
T11247	1" dia.	12"	3"	2"	2 ³ / ₄ "	1 ³ / ₄ "	4.1 lbs.
T11847	1" dia.	18"	3"	2"	2 ³ / ₄ "	1 ³ / ₄ "	4.6 lbs.

ROCKWOOD®

ASSA ABLOY

Experience a safer
and more open world

800 458 2424 | www.rockwoodmfg.com
Check the web site for the up-to-date catalog

Copyright © 2012-2024, ASSA ABLOY Accessories and Door Controls Group, Inc. All rights reserved. Reproduction in whole or in part without the express written permission of ASSA ABLOY Accessories and Door Controls Group, Inc. is prohibited.



TBF47 Series Offset Tubular Single Bar Sets

Material: Brass, bronze, stainless steel

Finishes: Available in standard architectural finishes (see page 9)

Mounting:

Door	Pull Free End	Push Free End	Common End	Description	Mounting Spec. No.
Metal & wood	1	1	5	Back to back & thru bolt	T3**
Metal	17	17	16	Back to back & concealed	T4
Wood	8	8	5	Back to back & concealed	T5
Metal & wood	12	12	5	Back to back & decorative bolt	T1
Glass	15	15	13	Back to back & thru bolt	T2

**T3 is the standard mounting method for metal and wood doors.

NOTE: See page A10 for detailed mounting drawings

Ordering: Specify product number, mounting, door type, push bar CTC, and finish (TBF15747 T3, wood door, 33" CTC, US32D)

Other: See page A1 on "How To" size push bars

Options:

- Engraving "PUSH" or "PULL". Specify handing
- Base plates available similar to those shown on page A12 – use BP prefix (TBF15747) when ordering

No.	Material Size	Pull			Push		Weight
		CTC	Projection	Clearance	Projection	Clearance	
TBF15647	1" dia.	8"	3½"	2½"	2¾"	1¾"	4.2 lbs.
TBF157A47	1" dia.	9"	3½"	2½"	2¾"	1¾"	4.3 lbs.
TBF15747	1" dia.	10"	3½"	2½"	2¾"	1¾"	4.3 lbs.
TBF15847	1" dia.	12"	3½"	2½"	2¾"	1¾"	4.4 lbs.
TBF15947	1" dia.	18"	3½"	2½"	2¾"	1¾"	4.9 lbs.

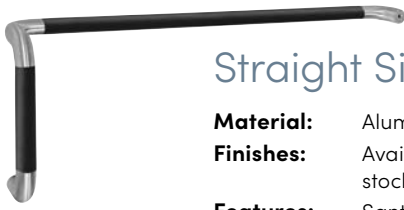

Straight Single Bar Set with Santoprene Grip No. 19049

- Material:** Aluminum
- Finishes:** Available in US28, 313, 314, 315, 10BE, BSP (Black Suede), WSP (White Suede), stock powder coat finishes (see page 9)
- Features:** Santoprene™ durable weather resistant grip
- Mounting:**

Door	Pull Free End	Push Free End	Common End	Description	Mounting Spec. No.
Metal & wood	1	1	5	Back to back & thru bolt	T3**
Metal & wood	6	6	5	Back to back & concealed	T4
Wood	8	8	5	Back to back & concealed	T5
Metal & wood	12	12	5	Back to back & decorative bolt	T1
Glass	15	15	13	Back to back & thru bolt	T2

**T3 is the standard mounting method for Metal and Wood Doors
(See mounting selections at rockwoodmfg.com)

- Ordering:** Specify product number, mounting, door type, push bar CTC, and finish (i.e., 19049 T3, wood door, 33" CTC, US28)
- Options:** Base plates available — use BP prefix (BP19049) when ordering
Advise if door thickness is other than 1³/₄"

No.	Material Size	Pull CTC	Pull Projection	Pull Clearance	Push CTC	Push Projection	Push Clearance	Weight
19049	1" dia.	12"	3 ¹ / ₂ "	2"	36"	2 ³ / ₄ "	1 ³ / ₄ "	11.7 lbs.

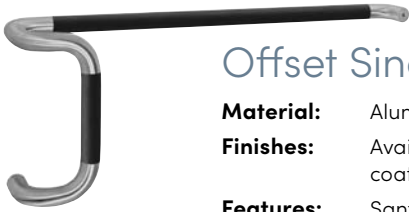

Offset Single Bar Set with Santoprene Grip No. BF19549

- Material:** Aluminum
- Finishes:** Available in US28, 313, 314, 315, 10BE, BSP (Black Suede), WSP (White Suede), stock powder coat finishes (see page 9)
- Features:** Santoprene™ durable weather resistant grip
- Mounting:**

Door	Pull Free End	Push Free End	Common End	Description	Mounting Spec. No.
Metal & wood	1	1	5	Back to back & thru bolt	T3**
Metal & wood	17	17	16	Back to back & concealed	T4
Wood	8	8	5	Back to back & concealed	T5
Metal & wood	12	12	5	Back to back & decorative bolt	T1
Glass	15	15	13	Back to back & thru bolt	T2

**T3 is the standard mounting method for Metal and Wood Doors
(See mounting selections at rockwoodmfg.com)

- Ordering:** Specify product number, mounting, door type, push bar CTC, and finish (i.e., BF19549 T3, wood door, 33" CTC, US28)
- Options:** Base plates available — use BP prefix (BPBF19049) when ordering
Advise if door thickness is other than 1³/₄"

No.	Material Size	Pull CTC	Pull Projection	Pull Clearance	Push CTC	Push Projection	Push Clearance	Weight
BF19549	1" dia.	18"	3 ¹ / ₂ "	2 ¹ / ₂ "	36"	2 ³ / ₄ "	1 ³ / ₄ "	15.2 lbs.

ROCKWOOD®

ASSA ABLOY

Experience a safer
and more open world

800 458 2424 | www.rockwoodmfg.com
Check the web site for the up-to-date catalog

Copyright © 2012–2024, ASSA ABLOY Accessories and Door Controls Group, Inc. All rights reserved. Reproduction in whole or in part without the express written permission of ASSA ABLOY Accessories and Door Controls Group, Inc. is prohibited.

Location Standards

Positioning Applications:

- Door pulls to plates
- Cutouts on plates
- Engraving on plates
- Cutout and engraving on plates

Sizing:

- 1 1/4" standard cylinder hole cutout size
- 3/8" diameter standard turn knob hole
- Other cutout sizes and styles are readily available

Engraving:

- 1" high condensed block letters with black enamel fill
- Other letter sizes and styles are readily available

NOTE: Be sure the pull you choose will fit on the plate, allowing for cutouts and/or engraving

ADA Accessibility Guidelines for Buildings and Facilities (ADAAG)

As amended through 2004

4.13.9 Door Hardware. Handles, pulls, latches, locks, and other operating devices on accessible doors shall have a shape that is easy to grasp with one hand and does not require tight grasping, tight pinching, or twisting of the wrist to operate. Lever-operated mechanisms, push-type mechanisms, and U-shaped handles are acceptable designs. When sliding doors are fully open, operating hardware shall be exposed and usable from both sides. Hardware required for accessible door passage shall be mounted no higher than 48" (1220 mm) above finished floor.

Pull Positioning on Plates 4" or Less in Width

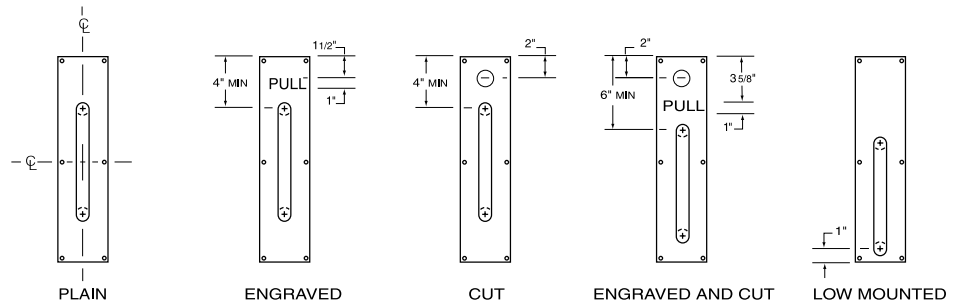

Pull Positioning on Plates Wider than 4" (Handing Required)

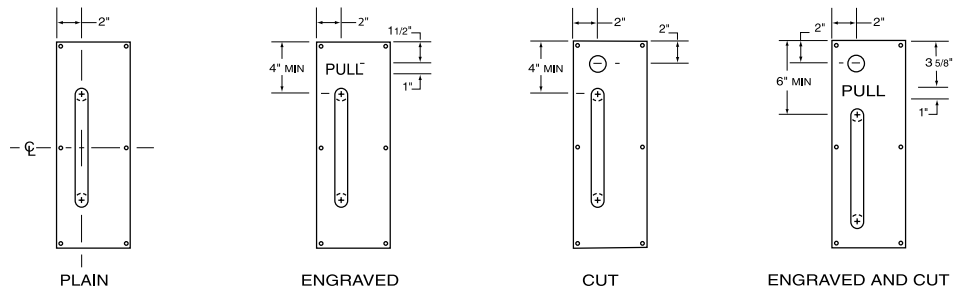

Recommended Locations on Door

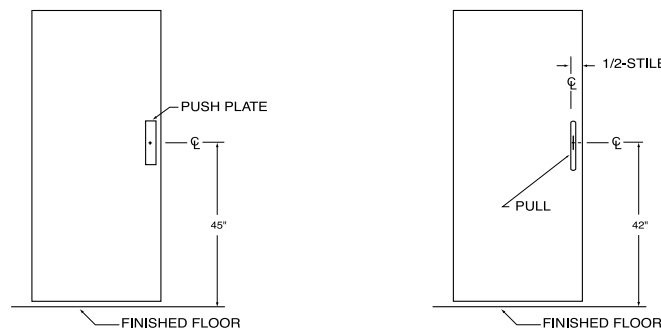

800 458 2424 | www.rockwoodmfg.com
Check the web site for the up-to-date catalog

Copyright © 2012-2024, ASSA ABLOY Accessories and Door Controls Group, Inc. All rights reserved. Reproduction in whole or in part without the express written permission of ASSA ABLOY Accessories and Door Controls Group, Inc. is prohibited.

ROCKWOOD®
ASSA ABLOY

Experience a safer
and more open world

Push Plates – .050" Thick

Material: Aluminum, brass, bronze, stainless steel

Finishes: Available in standard architectural finishes, US32DMS, and US32D316 (see page 9)

Fastener: #6 x 5/8" OH SMS

Features: Four beveled edges

Ordering: Specify plate number followed by size designation and finish (70B US32D) or for non-standard size 70. Specify width x height and finish. Specify any additional options

- Options:**
- Custom sizes available upon request
 - TEK – self-drilling screws
 - TORX – security Torx screws
 - SA – self-adhesive mounting: 1/16" double face foam tape (no screw holes on plate)
 - Engraving on plates 4" wide or wider. Specify copy. See page B1 for standard engraving locations
 - Cylinder cutouts (CFC) and turn knob cutouts (CFTT). See page B1 for standard locations and sizes
 - Heavy bevel available on 70A to 70G, specify HVBEV



No. 70

No.	Standard Size	Weight
70A	3" x 12"	0.7 lbs.
70B	3 1/2" x 15"	0.9 lbs.
70C-RKW	4" x 16"	1.0 lbs.
70E	6" x 16"	1.5 lbs.
70F	8" x 16"	2.0 lbs.
70G	4" x 20"	1.3 lbs.



No. 70RC

No.	Standard Size	Weight
70RCA	3" x 12"	0.7 lbs.
70RCB	3 1/2" x 15"	0.9 lbs.
70RCC	4" x 16"	1.0 lbs.
70RCE	6" x 16"	1.5 lbs.
70RCF	8" x 16"	2.0 lbs.
70RCG	4" x 20"	1.3 lbs.



No. 70RE

No.	Standard Size	Weight
70REA	3" x 12"	0.7 lbs.
70REB	3 1/2" x 15"	0.9 lbs.
70REC	4" x 16"	1.0 lbs.

ROCKWOOD®

ASSA ABLOY

Experience a safer
and more open world

800 458 2424 | www.rockwoodmfg.com
Check the web site for the up-to-date catalog

Copyright © 2012-2024, ASSA ABLOY Accessories and Door Controls Group, Inc. All rights reserved. Reproduction in whole or in part without the express written permission of ASSA ABLOY Accessories and Door Controls Group, Inc. is prohibited.

Push Plates – .062" Thick

Material: Stainless steel

Finishes: Available in standard architectural finishes (see page 9)

Fastener: #6 x 5/8" OH SMS

Features: Four beveled edges

Ordering: Specify plate number followed by size designation and finish (71B US32D) or for non-standard size 71
Specify width x height and finish. Specify any additional options

- Options:**
- Custom sizes available upon request
 - TEK – self-drilling screws
 - TORX – security Torx screws
 - SA – self-adhesive mounting: 1/16" double face foam tape (no screw holes on plate)
 - Engraving on plates 4" wide or wider. Specify copy. See page B1 for standard engraving locations
 - Cylinder cutouts (CFC) and turn knob cutouts (CFTT). See page B1 for standard locations and sizes



No. 71

No.	Standard Size	Weight
71A	3" x 12"	0.9 lbs.
71B	3 1/2" x 15"	1.1 lbs.
71C	4" x 16"	1.2 lbs.
71E	6" x 16"	1.8 lbs.
71F	8" x 16"	2.4 lbs.
71G	4" x 20"	1.5 lbs.



No. 71RC

No.	Standard Size	Weight
71RCA	3" x 12"	0.9 lbs.
71RCB	3 1/2" x 15"	1.1 lbs.
71RCC	4" x 16"	1.2 lbs.
71RCE	6" x 16"	1.8 lbs.
71RCF	8" x 16"	2.4 lbs.
71RCG	4" x 20"	1.5 lbs.



No. 71RE

No.	Standard Size	Weight
71REA	3" x 12"	0.9 lbs.
71REB	3 1/2" x 15"	1.1 lbs.
71REC	4" x 16"	1.2 lbs.

Push Plates – .125" Thick

Material: Aluminum, brass, bronze, stainless steel

Finishes: Available in standard architectural finishes, and US32D316 (see page 9)

Fastener: #6 x ⁵/₈" OH SMS

Features: Four beveled edges

Ordering: Specify plate number followed by size designation and finish (73B US32D) or for non-standard size 73. Specify width x height and finish. Specify any additional options

- Options:**
- Custom sizes available upon request
 - TEK – self-drilling screws
 - TORX – security Torx screws
 - SA – self-adhesive mounting: ¹/₁₆" double face foam tape (no screw holes on plate)
 - Engraving on plates 4" wide or wider. Specify copy. See page B1 for standard engraving locations
 - Cylinder cutouts (CFC) and turn knob cutouts (CFTT). See page B1 for standard locations and sizes



No. 73

No.	Standard Size	Weight
73A	3" x 12"	1.7 lbs.
73B	3½" x 15"	2.1 lbs.
73C	4" x 16"	2.5 lbs.
73E	6" x 16"	3.8 lbs.
73F	8" x 16"	5.0 lbs.
73G	4" x 20"	3.2 lbs.



No. 73RC

No.	Standard Size	Weight
73RCA	3" x 12"	1.7 lbs.
73RCB	3½" x 15"	2.1 lbs.
73RCC	4" x 16"	2.5 lbs.
73RCE	6" x 16"	3.8 lbs.
73RCF	8" x 16"	5.0 lbs.
73RCG	4" x 20"	3.2 lbs.



No. 73RE

No.	Standard Size	Weight
73REA	3" x 12"	1.7 lbs.
73REB	3½" x 15"	2.1 lbs.
73REC	4" x 16"	2.5 lbs.

ROCKWOOD®

ASSA ABLOY

Experience a safer
and more open world

800 458 2424 | www.rockwoodmfg.com
Check the web site for the up-to-date catalog

Copyright © 2012–2024, ASSA ABLOY Accessories and Door Controls Group, Inc. All rights reserved. Reproduction in whole or in part without the express written permission of ASSA ABLOY Accessories and Door Controls Group, Inc. is prohibited.

Push Plates – .125" Thick No. 75

Material: Plastic laminate, clear plastic, Kydex®

Colors: Black, brown, gray, beige, white, and clear

Fastener: #6 x 5/8 OH SMS

Features: Four beveled edges

Ordering: Specify color and any other options

- Options:**
- Custom sizes available upon request
 - SA – Self-adhesive mounting: 1/16" double face foam tape (no screw holes on plate). Not available on clear plastic
 - Engraving on plates 4" wide or wider. Specify copy. See page B1 for standard engraving locations
 - Cylinder cutouts (CFC) and turn knob cutouts (CFTT). See page B1 for standard locations and sizes



No.	Standard Size	Weight
75A	3" x 12"	0.3 lbs.
75B	3 1/2" x 15"	0.4 lbs.
75C	4" x 16"	0.5 lbs.
75E	6" x 16"	0.7 lbs.
75F	8" x 16"	0.9 lbs.
75G	4" x 20"	0.6 lbs.

® Kydex is a registered trademark of Kleardex Company.

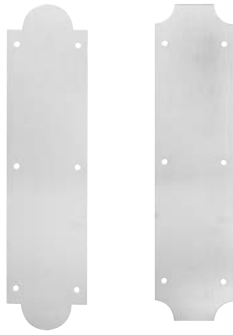

No. 76

No. 77

Decorative Push Plates – .050" Thick No. 76, 77

Material: Brass, bronze

Finishes: Available in standard architectural finishes (see page 9)

Fastener: #6 x 5/8" OH SMS

Ordering: Specify finish

Options: These plates look great when combined with the No. 147 or 148 pulls as shown on page B22

No.	Standard Size	Weight
76B	3 1/2" x 15"	0.9 lbs.
76C	4" x 16"	1.0 lbs.
77B	3 1/2" x 15"	0.9 lbs.
77C	4" x 16"	1.0 lbs.



Push Plates – .050" Thick No. 80, 81, 82

Material: Aluminum, brass, bronze, stainless steel

Finishes: Available in standard architectural finishes, US32DMS, and US32D316 (see page 9)

Fastener: #6 x 5/8" OH SMS

Ordering: Specify finish

Options:

- Plates may be mated with most any door pull of your choice
- Custom sizes available upon request

No.	Standard Size	Weight
80	6" x 12"	1.4 lbs.
81	7 1/2" x 15"	1.6 lbs.
82	8" x 16"	1.8 lbs.



Push Plate – .050" Thick No. 84

Material: Aluminum, brass, bronze, stainless steel

Finishes: Available in standard architectural finishes, US32DMS, and US32D316 (see page 9)

Fastener: #6 x 5/8" OH SMS

Ordering: Specify finish and handing (right handing shown)

Options:

- Variations of design can be created to fit your requests
- Plate may be mated with most any door pull of your choice

No.	Standard Size	Weight
84	10" x 20"	2.1 lbs.

ROCKWOOD®

ASSA ABLOY

Experience a safer
and more open world

800 458 2424 | www.rockwoodmfg.com
Check the web site for the up-to-date catalog

Copyright © 2012–2024, ASSA ABLOY Accessories and Door Controls Group, Inc. All rights reserved. Reproduction in whole or in part without the express written permission of ASSA ABLOY Accessories and Door Controls Group, Inc. is prohibited.



Push Plates – .050" Thick No. 85, 86

- Material:** Aluminum, brass, bronze, stainless steel
- Finishes:** Available in standard architectural finishes, and US32DMS (see page 9)
- Fastener:** #6 x 5/8" OH SMS
- Features:** Cold forged to 7/32" thick
- Ordering:** Specify finish
- Options:** Plates may be mated with most any door pull of your choice

No.	Standard Size	Weight
85	3 1/2" x 15"	0.9 lbs.
86	4" x 16"	1.0 lbs.



Push Plate – .125" Thick No. 87

- Material:** Aluminum, brass, bronze, stainless steel
- Finishes:** Available in standard architectural finishes (see page 9)
- Fastener:** #6 x 5/8" OH SMS
- Ordering:** Specify finish
- Options:**
- Variations of design can be created to fit your requests
 - Plate may be mated with most any door pull of your choice

No.	Standard Size	Weight
87	2 5/8" x 16"	2.0 lbs.



Heavy Duty Security Flush Pull No. D89

- Material:** Cast brass
- Finishes:** Available in US4, 10BE and US26D (see page 9)
- Fastener:** 1/4 - 20 x 1/2" OH Security Torx MS
#14 x 1" OH Security Torx SMS

No.	Size	Grip Opening	Depth	Weight
D89	4" x 5"	1 3/4" x 3 1/2"	7/8"	1.3 lbs.



Cylinder Pulls No. 90, 90B

- Material:** .125" aluminum, brass, bronze, stainless steel
- Finishes:** Available in standard architectural finishes, and **US32DMS** (see page 9)
- Fastener:** #8 x 3/4" OH SMS
- Options:** No cylinder hole – screw mounted, order No. 90B

No.	Size	Opening	Projection	Weight
90	2" x 3 3/4"	1 1/4" dia.	1"	0.3 lbs.
90B	2" x 3 3/4"	—	1"	0.3 lbs.



Combination Push Pull Plates No. 91-RKW, 92-RKW, 93-RKW

- Material:** .125" aluminum, brass, bronze, stainless steel
- Finishes:** Available in standard architectural finishes, and **US32DMS** (see page 9)
- Fastener:** #8 x 7/8" SMS
- Options:**
- TORX – security Torx screws
 - Cylinder cutouts (CFC) and turn knob cutouts (CFTT). See page B1 for standard locations and sizes

No.	Size	Projection	Weight
91-RKW	3 1/2" x 15 3/4"	1"	1.9 lbs.
92-RKW	4" x 15 3/4"	1"	2.2 lbs.
93-RKW	8" x 15 3/4"	1"	4.4 lbs.

ROCKWOOD®

ASSA ABLOY

Experience a safer
and more open world

800 458 2424 | www.rockwoodmfg.com
Check the web site for the up-to-date catalog

Copyright © 2012-2024, ASSA ABLOY Accessories and Door Controls Group, Inc. All rights reserved. Reproduction in whole or in part without the express written permission of ASSA ABLOY Accessories and Door Controls Group, Inc. is prohibited.



Flush Pulls No. 94, 94BTB

Material: .125" brass, bronze, stainless steel

Finishes: Available in standard architectural finishes, US32DMS, US32D316, and US32316 (see page 9)

NOTE: Cups are painted black on all finishes except stainless steel.

Fastener: No. 94: #8 x 3/4" SMS

No. 94BTB: #8 - 32 x 3/4" OH MS with sleeves Type 10

Options: TORX – security Torx screws

No.	Size	Grip Opening	Depth	Weight
94	3 1/2" x 5"	1 3/4" x 3 1/8"	7/8"	0.6 lbs.
94BTB (pair)	3 1/2" x 5"	1 3/4" x 3 1/8"	1 3/4"	1.2 lbs.



Flush Pull No. 94C

Material: .125" brass, bronze, stainless steel

Finishes: Available in standard architectural finishes, US32DMS, US32D316, and US32316 (see page 9)

NOTE: Cups are painted black on all finishes except stainless steel

Fastener: #6 x 1" TH SMS.

Features:

- Fasteners concealed in cup.
- Accepted by the New York State Office of Mental Health (OMH) for use in high risk areas

No.	Size	Grip Opening	Depth	Weight
94C	3 1/2" x 5"	1 3/4" x 3 1/8"	7/8"	0.6 lbs.

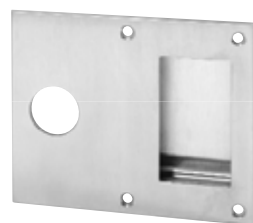

Dead Lock Flush Pulls No. 94DLL, 94DLS

Material: .125" brass, bronze, stainless steel

Finishes: Available in standard architectural finishes, US32DMS, US32D316, and US32316 (see page 9)

NOTE: Cups are painted black on all finishes except stainless steel

Fastener: #8 x 3/4" OH SMS.

Features:

- Used with dead bolt lock. 1 1/4" cylinder hole is standard
- Vandal resistant.
- Use where projecting trim is an operational problem or an aesthetic objection
- Ideal for use on "exit only" doors where occasional entrance is required (warehouse exits), night latch function exit device openings (classroom exit only doors), mechanical closet doors and anywhere dead locking is approved

Options:

- TORX – security Torx screws
- Custom sizes

No.	Size	Grip Opening	Depth	Weight
94DLL	6 1/8" x 8"	1 3/4" x 6 1/8"	7/8"	1.0 lbs.
94DLS	6 1/8" x 5"	1 3/4" x 3 1/8"	7/8"	0.8 lbs.



Flush Pull No. 94L

- Material:** .125" brass, bronze, stainless steel
- Finishes:** Available in standard architectural finishes, US32DMS, US32D316, and US32316 (see page 9)
NOTE: Cups are painted black on all finishes except stainless steel
- Fastener:** 1/4"-20 x 1 1/2" thru bolt & finish washer (standard 1 3/4" door)
- Features:** Includes lugs for thru bolt. No fasteners on pull side
- Options:**
- TORX – security Torx screws
 - Advise if door thickness other than 1 3/4"

No.	Size	Grip Opening	Depth	Weight
94L	3 1/2" x 5"	1 3/4" x 3 1/8"	7/8"	0.6 lbs.



Flush Pull No. 94P

- Material:** .125" brass, bronze, stainless steel
- Finishes:** Available in standard architectural finishes, US32DMS, US32D316, and US32316 (see page 9)
NOTE: Cups are painted black on all finishes except stainless steel
- Fastener:** 1/4"-20 x 1 1/2" MS
- Features:** Usually used with the 94L as a set (see below)
- Options:** TORX – security Torx screws

No.	Size	Grip Opening	Depth	Weight
94P	3 1/2" x 5"	1 3/4" x 3 1/8"	7/8"	0.6 lbs.

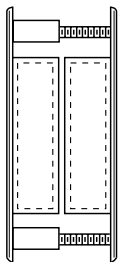

Flush Pull Set No. 94P x 94L

- Material:** .125" brass, bronze, stainless steel
- Finishes:** Available in standard architectural finishes, US32DMS, US32D316, and US32316 (see page 9)
NOTE: Cups are painted black on all finishes except stainless steel
- Fastener:** 1/4" - 20 x 1 1/2" thru bolt (standard 1 3/4" door)
- Options:**
- TORX – security Torx screws
 - Advise if door thickness other than 1 3/4"

No.	Size	Weight
94P x 94L	Set consists of 1 94L and 1 94P	1.3 lbs.

ROCKWOOD®

ASSA ABLOY

Experience a safer
and more open world

800 458 2424 | www.rockwoodmfg.com
Check the web site for the up-to-date catalog

Copyright © 2012–2024, ASSA ABLOY Accessories and Door Controls Group, Inc. All rights reserved. Reproduction in whole or in part without the express written permission of ASSA ABLOY Accessories and Door Controls Group, Inc. is prohibited.



Flush Pull No. 95A

Material: Cast brass

Finishes: Available in standard architectural finishes (see page 9)

Fastener: #6 x $\frac{5}{8}$ " SMS

Features: Fasteners concealed in cup

No.	Size	Grip Opening	Depth	Weight
95A	2 $\frac{3}{16}$ " x 3 $\frac{1}{4}$ "	$\frac{7}{8}$ " x 2 $\frac{7}{16}$ "	$\frac{3}{4}$ "	0.6 lbs.



Flush Pull No. 95B

Material: Cast brass

Finishes: Available in standard architectural finishes (see page 9)

Fastener: #8 x $\frac{7}{8}$ " SMS

Features: Fasteners concealed in cup

No.	Size	Grip Opening	Depth	Weight
95B	2 $\frac{11}{16}$ " x 4 $\frac{3}{16}$ "	1 $\frac{7}{16}$ " x 3 $\frac{1}{2}$ "	$\frac{3}{4}$ "	0.8 lbs.



Flush Pull No. 95R

Material: Cast brass

Finishes: Available in standard architectural finishes (see page 9)

Fastener: #8 x $\frac{7}{8}$ " SMS

Features: Fasteners concealed in cup

No.	Size	Grip Opening	Depth	Weight
95R	3 $\frac{1}{2}$ " dia.	2 $\frac{3}{4}$ " x 1 $\frac{11}{16}$ "	$\frac{7}{8}$ "	0.6 lbs.

Flush Pull No. 96



- Material:** .125" aluminum, brass, bronze, stainless steel
- Finishes:** Available in standard architectural finishes (see page 9)
- Fastener:** #8 x 3/4" FH SMS
- Options:**
- TORX – security Torx screws
 - Special sizes
 - Cylinder cutouts (CFC) and turn knob cutouts (CTFF). See page B1 for standard locations and sizes

No.	Size	Grip Opening	Depth	Weight
96	4" x 16"	1 3/4" x 3 1/8"	7/8"	2.2 lbs.



No. BF97

Barrier Free Flush Pulls No. BF97, BF97L

- Material:** .125" brass, bronze, stainless steel
- Finishes:** Available in standard architectural finishes, and US32DMS (see page 9).
- Fastener:** No. BF97: #8 x 3/4" FH SMS
No. BF97L: #8 - 32 stud welded lugs and #8 - 32 FH MS
- Options:** TORX – security Torx screws
- Features:** ADA flush pull



No. BF97L

No.	Size	Grip Opening	Depth	Weight
BF97	5" x 5"	2 1/2" x 3 1/2"	7/8"	1.0 lbs.
BF97L	5" x 5"	2 1/2" x 3 1/2"	7/8"	1.0 lbs.

ROCKWOOD®

ASSA ABLOY

Experience a safer
and more open world

800 458 2424 | www.rockwoodmfg.com
Check the web site for the up-to-date catalog

Copyright © 2012–2024, ASSA ABLOY Accessories and Door Controls Group, Inc. All rights reserved. Reproduction in whole or in part without the express written permission of ASSA ABLOY Accessories and Door Controls Group, Inc. is prohibited.

Thru Bolt

Wood or Metal Door – Type 1

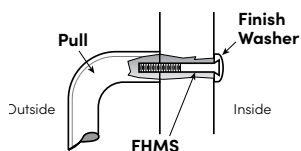

Type	Bolt Size	Drill Size	
		Wood	Metal
1	1/4 - 20	9/32	9/32
1HD	5/16 - 18	11/32	11/32
1XHD	3/8 - 16	13/32	13/32

Wood or Metal Door – Type 12

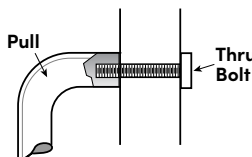

Type	Bolt Size	Drill Size	
		Wood	Metal
12	1/4 - 20	9/32	9/32
12HD	5/16 - 18	11/32	11/32
12XHD	3/8 - 16	13/32	13/32

Glass Door – Type 15

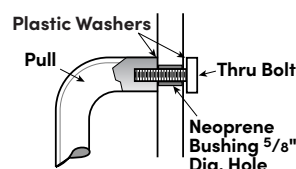

Type	Bolt Size	Drill Size
		Glass
15	1/4 - 20	5/8
15HD	5/16 - 18	5/8
15XHD	3/8 - 16	5/8

NOTE: Heavy Duty (HD/XHD) mounting features hex drive for positive tightening and large overall size for superior strength. Recommended for high frequency and rough service openings.

Back to Back

Wood or Metal Door – Type 5

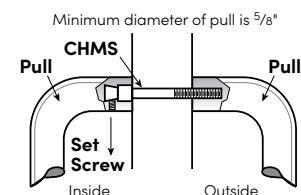

Type	Bolt Size	Drill Size	
		Wood	Metal
5	1/4 - 20	9/32	9/32
5HD	5/16 - 18	11/32	11/32

Any Door Type – Type 9

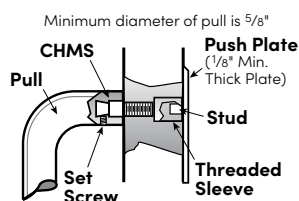

Type	Bolt Size	Drill Size
		Metal
9	1/4 - 20	N/A

Glass Door – Type 13

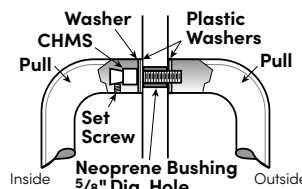

Type	Bolt Size	Drill Size
		Glass
13	1/4 - 20	5/8
13HD	5/16 - 18	5/8

Surface Concealed

Metal Door – Type 6

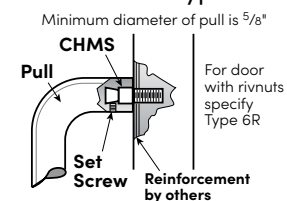

Type	Bolt Size	Drill Size
		Metal
6	1/4 - 20	1/4 - 20 tap
6HD	5/16 - 18	5/16 - 18 tap

Metal Door – Type 6R

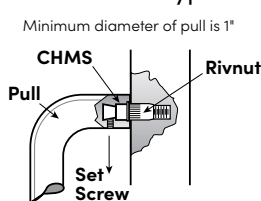

Type	Bolt Size	Drill Size
		Metal
6R	1/4 - 20	N/A

Wood Door – Type 8

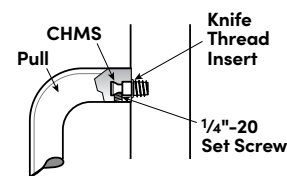

Type	Bolt Size	Drill Size
		Wood
8	1/4 - 20	23/64 x 9/16 dp
8HD	5/16 - 18	7/16 x 9/16 dp

Flush Pull Mounting

Wood or Metal Door – Type 10

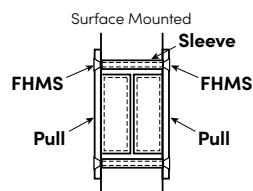

Type	Bolt Size	Drill Size	
		Wood	Metal
10	8 - 32	9/32	9/32

Type 10 Mounting applies to the 94 Series Flush Pulls

Wire or Small PostMount Pull Mounting

Wood or Metal Door – Type 5S

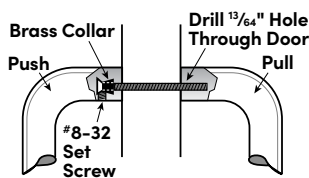

Type	Bolt Size	Drill Size	
		Wood	Metal
5S	8 - 32	13/64	13/64

NOTE: This mounting should only be used on pulls with mounting points that are 1/2" in diameter.

Surface Concealed Wood or Metal Door – Type 6S

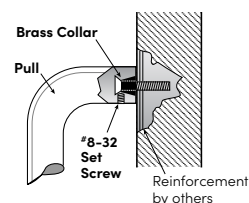

Type	Bolt Size	Drill Size
		Wood Metal
6S	8 - 32	8 - 32 Tap



Door Pulls No. 102-RKW, 105, 106-RKW, 107, 108, 109

Material: Aluminum, brass, bronze, stainless steel

Finishes: Available in standard architectural finishes, US32DMS, US32D316, US32316, white (WPC), red (RPC), and black (BPC) powder coat finishes (see page 9)

Fastener: 1/4-20x2 1/4" thru bolt & finish washer (standard 1 3/4" door)

- Options:**
- Back to back mounting in pairs – use BTB suffix and mounting type number (107BTB5)
 - Concealed mounting single pulls – use C suffix and mounting type number (107C6)
 - Advise if door thickness is other than 1 3/4"
 - See page B13 for mounting selection (standard duty 1/4-20)
 - 2 1/2" Barrier Free clearance – use BF prefix (BF107)

No.	Material Size	CTC	Overall	Base	Projection	Clearance	Weight
102-RKW	5/8" dia.	5 1/2"	6 1/8"	5/8"	2 1/8"	1 1/2"	0.6 lbs.
105	3/4" dia.	5 1/2"	6 1/4"	3/4"	2 5/8"	1 7/8"	1.2 lbs.
106-RKW	3/4" dia.	6"	6 3/4"	3/4"	2 5/8"	1 7/8"	1.3 lbs.
107	3/4" dia.	8"	8 3/4"	3/4"	2 5/8"	1 7/8"	1.6 lbs.
108	3/4" dia.	10"	10 3/4"	3/4"	2 5/8"	1 7/8"	1.8 lbs.
109	3/4" dia.	12"	12 3/4"	3/4"	2 5/8"	1 7/8"	2.1 lbs.

Door Pulls No. 110-RKW, 111A, 111, 112, 118



Material: Aluminum, brass, bronze, stainless steel

Finishes: Available in standard architectural finishes, US32DMS, US32D316, US32316, white (WPC), red (RPC), and black (BPC) powder coat finishes (see page 9)

Fastener: 1/4-20x2 1/4" thru bolt & finish washer (standard 1 3/4" door)

- Options:**
- Back to back mounting in pairs – use BTB suffix and mounting type number (112BTB5)
 - Concealed mounting single pulls – use C suffix and mounting type number (112C6)
 - Advise if door thickness is other than 1 3/4"
 - Heavy duty versions of most fastening types available – use suffix HD to fastening type number (112BTB5HD)
 - See page B13 for mounting selection (standard duty 1/4-20)
 - 2 1/2" Barrier Free clearance – use BF prefix (BF110)

No.	Material Size	CTC	Overall	Base	Pull Projection (Stainless)	Pull Projection (Brass, Bronze)	Clearance (Stainless)	Clearance (Brass Bronze)	Weight
110-RKW	1" dia.	8"	9"	1"	3 1/2"	3"	2 1/2"	2"	3.0 lbs.
111A	1" dia.	9"	10"	1"	3 1/2"	3"	2 1/2"	2"	3.3 lbs.
111	1" dia.	10"	11"	1"	3 1/2"	3"	2 1/2"	2"	3.5 lbs.
112	1" dia.	12"	13"	1"	3 1/2"	3"	2 1/2"	2"	4.0 lbs.
118	1" dia.	18"	19"	1"	3 1/2"	3"	2 1/2"	2"	5.4 lbs.

Pull projection is 3 1/2" for stainless steel and 3" for aluminum, brass and bronze.

ROCKWOOD

ASSA ABLOY

Experience a safer
and more open world

800 458 2424 | www.rockwoodmfg.com
Check the web site for the up-to-date catalog

Copyright © 2012-2024, ASSA ABLOY Accessories and Door Controls Group, Inc. All rights reserved. Reproduction in whole or in part without the express written permission of ASSA ABLOY Accessories and Door Controls Group, Inc. is prohibited.

T Series 1" Tubular Pulls

Rockwood T Series 1" diameter straight tubular pulls are made from sturdy .065" thick wall tubing. Solid brass or stainless steel inserts are brazed into the ends to provide a solid area for our guaranteed mounting systems.

Benefits of specifying the T Series push and pulls include:

- Tubular pulls weigh 25% less than their solid counterparts; this 75% weight reduction greatly reduces the environmental impact of harvesting material for their manufacture – a LEED certified building goal
- The lighter weight minimizes the risk of damage in shipping and handling
- The cost of most tubular pulls represents a significant savings over the equivalent solid model

Considering all the benefits, the T Series pulls offer an improved value without any quality sacrifice.

T Series is also available in offset pulls (see page B29) and in both Series 47 push bars and push & pull bar sets (see pages A19–A21).



Tubular Door Pulls No. T110, T111A, T111, T112, T118

Material: Brass, bronze, stainless steel

Finishes: Available in standard architectural finishes (see page 9)

Fastener: 1/4 - 20 x 2 1/4" thru bolt & finish washer (standard 1 3/4" door)

- Options:**
- Back to back mounting in pairs – use BTB suffix and mounting type number (T112BTB5)
 - Concealed mounting single pulls – use C suffix and mounting type number (T112C6)
 - Advise if door thickness is other than 1 3/4"
 - See page B13 for mounting selection (standard duty 1/4 - 20)
 - 2 1/2" Barrier Free clearance – use BF prefix (TBF110)

No.	Material Size	CTC	Overall	Base	Pull Projection (Stainless)	Pull Projection (Brass, Bronze)	Clearance (Stainless)	Clearance (Brass Bronze)	Weight
T110	1" dia.	8"	9"	1"	3 1/2"	3"	2 1/2"	2"	1.0 lbs.
T111A	1" dia.	9"	10"	1"	3 1/2"	3"	2 1/2"	2"	1.1 lbs.
T111	1" dia.	10"	11"	1"	3 1/2"	3"	2 1/2"	2"	1.1 lbs.
T112	1" dia.	12"	13"	1"	3 1/2"	3"	2 1/2"	2"	1.2 lbs.
T118	1" dia.	18"	19"	1"	3 1/2"	3"	2 1/2"	2"	1.7 lbs.

Pull projection is 3 1/2" for stainless steel and 3" for aluminum, brass and bronze.



Concealed Mount Pull Plate Sets

No. 107 x 73B/73BL, 110 x 73C/73CL, 111 x 73C/73CL

Material: Stainless steel

Finishes: US32D

Fastener: Type 9. Stud welded lugs on the back of the push plate are permanently attached to the 1/8" thick push plate. Cone head MS attached to selected door pull

Features:

- This set has no perimeter screw holes in either plate
- Concealed mounting system. Any of the rod type door pulls from No. 105 to No. 118 are appropriate for this application

Options:

- Engraving on plates 4" wide or wider. Specify copy. See page B1 for standard engraving locations
- Cylinder cutouts (CFC) and turn knob cutouts (CFTT). See page B1 for standard locations and sizes
- *Other overall sizes available upon request

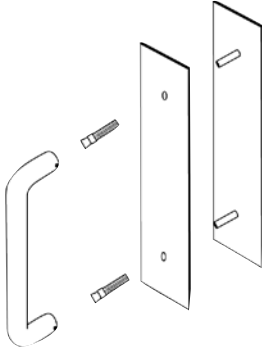

No.	Pull	Pull Size	Pull CTC	Pull Plate	Push Plate	Overall*	Weight
107x73B/73BL	107	3/4" dia.	8"	73B	73BL	3 1/2" x 15"	5.8 lbs.
110x73C/73CL	110	1" dia.	8"	73C	73CL	4" x 16"	8.0 lbs.
111x73C/73CL	111	1" dia.	10"	73C	73CL	4" x 16"	8.5 lbs.

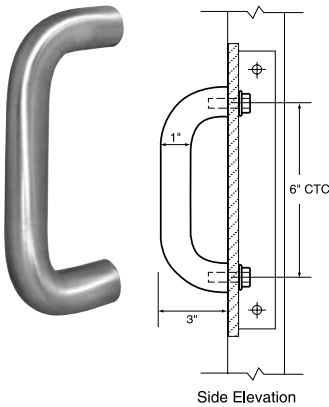

Security Door Pull No. 110-6SP

Material: Stainless steel

Finishes: US32D, US32DMS, 10BE

Fastener: 3/8" - 16 hex head MS with nylon patch

Features: For use on security hollow metal doors with reinforcing plate and access hole cover plate with TORX - security Torx screws - all to be supplied by door manufacturer

No.	Material Size	CTC	Overall	Base	Projection	Clearance	Weight
110-6SP	1" dia.	6"	7"	1"	3"	2"	2.4 lbs.

ROCKWOOD®

ASSA ABLOY

Experience a safer
and more open world

800 458 2424 | www.rockwoodmfg.com
Check the web site for the up-to-date catalog

Copyright © 2012-2024, ASSA ABLOY Accessories and Door Controls Group, Inc. All rights reserved. Reproduction in whole or in part without the express written permission of ASSA ABLOY Accessories and Door Controls Group, Inc. is prohibited.



Door Pulls with Base Plates No. Y102, Y105, Y106, Y107, Y108, Y109

- Material:** Aluminum, brass, bronze, stainless steel
- Finishes:** Available in standard architectural finishes, US32DMS, US32D316, US32316, white (WPC), red (RPC), and black (BPC) powder coat finishes (see page 9)
- Fastener:** 1/4"-20 x 2 1/2" thru bolt & finish washer (standard 1 3/4" door)
- Features:** 1/8" base plates improve stability on the door. Recommended for glass and wood doors
- Options:**
- Back to back mounting in pairs – use BTB suffix and mounting type number (Y107BTB5)
 - Concealed mounting single pulls – use C suffix and mounting type number (Y107C6)
 - Advise if door thickness is other than 1 3/4"
 - See page B13 for mounting selection (standard duty 1/4"-20)

No.	Material Size	CTC	Overall	Base	Projection	Clearance	Weight
Y102	5/8" dia.	5 1/2"	6 1/8"	7/8"	2 1/8"	1 1/2"	0.6 lbs.
Y105	3/4" dia.	5 1/2"	6 7/16"	1 1/16"	2 3/8"	1 5/8"	1.2 lbs.
Y106	3/4" dia.	6"	7 1/16"	1 1/16"	2 3/8"	1 5/8"	1.3 lbs.
Y107	3/4" dia.	8"	9 1/16"	1 1/16"	2 3/8"	1 5/8"	1.6 lbs.
Y108	3/4" dia.	10"	11 1/16"	1 1/16"	2 3/8"	1 5/8"	1.8 lbs.
Y109	3/4" dia.	12"	13 1/16"	1 1/16"	2 3/8"	1 5/8"	2.1 lbs.



Door Pulls with Base Plates No. Y110, Y111A, Y111, Y112, Y118

- Material:** Aluminum, brass, bronze, stainless steel
- Finishes:** Available in standard architectural finishes, US32DMS, US32D316, US32316, white (WPC), red (RPC), and black (BPC) powder coat finishes (see page 9)
- Fastener:** 1/4"-20 x 2 1/2" thru bolt & finish washer (standard 1 3/4" door)
- Features:** 1/8" base plates improve stability on the door. Recommended for glass and wood doors.
- Options:**
- Back to back mounting in pairs – use BTB suffix and mounting type number (Y112BTB5)
 - Concealed mounting single pulls – use C suffix and mounting type number (Y112C6)
 - Advise if door thickness is other than 1 3/4"
 - Heavy duty versions of most fastening types available – use suffix HD to fastening type number (Y112BTB5HD)
 - See page B13 for mounting selection (standard duty 1/4"-20)

No.	Material Size	CTC	Overall	Base	Projection	Clearance	Weight
Y110	1" dia.	8"	9 1/4"	1 1/4"	3 1/8"	2 1/8"	3.1 lbs.
Y111A	1" dia.	9"	10 1/4"	1 1/4"	3 1/8"	2 1/8"	3.4 lbs.
Y111	1" dia.	10"	11 1/4"	1 1/4"	3 1/8"	2 1/8"	3.6 lbs.
Y112	1" dia.	12"	13 1/4"	1 1/4"	3 1/8"	2 1/8"	4.1 lbs.
Y118	1" dia.	18"	19 1/4"	1 1/4"	3 1/8"	2 1/8"	5.5 lbs.



Door Pull No. 120

- Material:** Aluminum, brass, stainless steel
- Finishes:** Available in standard architectural finishes (see page 9)
- Fastener:** 1/4-20 x 2 1/4" thru bolt & finish washer (standard 1 3/4" door)
- Options:**
- Engraving available vertically
 - Back to back mounting
 - Advise if door thickness is other than 1 3/4"
 - See page B13 for mounting selection (standard duty 1/4-20)

No.	Material Size	CTC	Overall	Base	Projection	Clearance	Weight
120	3/8" x 1 1/4"	8"	14"	1" dia.	1 7/8"	1 3/8"	2.6 lbs.



Door Pull No. 121

- Material:** Aluminum, brass, stainless steel
- Finishes:** Available in standard architectural finishes (see page 9)
- Fastener:** 1/4-20 x 2 1/4" thru bolt & finish washer (standard 1 3/4" door)
- Options:**
- Engraving available vertically
 - Back to back mounting
 - Advise if door thickness is other than 1 3/4"
 - See page B13 for mounting selection (standard duty 1/4-20)

No.	Material Size	CTC	Overall	Base	Projection	Clearance	Weight
121	3/8" x 1 1/4"	8"	14"	1" dia.	1 7/8"	1 3/8"	2.6 lbs.



Door Pulls No. 122-RKW, 123

- Material:** Aluminum, brass, stainless steel
- Finishes:** Available in standard architectural finishes (see page 9)
- Fastener:** 1/4-20 x 2 1/4" thru bolt & finish washer (standard 1 3/4" door)
- Options:**
- Advise if door thickness is other than 1 3/4"
 - See page B13 for mounting selection (standard duty 1/4-20)

No.	Material Size	CTC	Overall	Projection	Clearance	Weight
122-RKW	3/8" x 1 1/4"	6"	6 3/8"	2"	1 5/8"	1.1 lbs.
123	3/8" x 1 1/4"	8"	8 3/8"	2"	1 5/8"	1.4 lbs.

ROCKWOOD[®]

ASSA ABLOY

Experience a safer
and more open world

800 458 2424 | www.rockwoodmfg.com
Check the web site for the up-to-date catalog

Copyright © 2012-2024, ASSA ABLOY Accessories and Door Controls Group, Inc. All rights reserved. Reproduction in whole or in part without the express written permission of ASSA ABLOY Accessories and Door Controls Group, Inc. is prohibited.



Door Pulls No. 125-RKW, 126-RKW

- Material:** Aluminum, brass, bronze, stainless steel
- Finishes:** Available in standard architectural finishes (see page 9)
- Fastener:** 1/4-20 x 2 1/4" thru bolt & finish washer (standard 1 3/4" door)
- Options:**
- Advise if door thickness is other than 1 3/4"
 - See page B13 for mounting selection (standard duty 1 1/4-20)

No.	Material Size	CTC	Overall	Projection	Clearance	Weight
125-RKW	1" half round	6"	6 1/2"	2"	1 1/2"	1.1 lbs.
126-RKW	1" half round	8"	8 1/2"	2"	1 1/2"	1.4 lbs.



Cast Door Pull No. 130-RKW

- Material:** Cast aluminum, brass, stainless steel
- Finishes:** Available in standard architectural finishes (see page 9)
- Fastener:** 1/4-20 x 2 1/4" thru bolt & finish washer (standard 1 3/4" door)
- Options:**
- Advise if door thickness is other than 1 3/4"
 - See page B13 for mounting selection (standard duty 1/4-20)

No.	CTC	Overall	Base	Projection	Clearance	Weight
130-RKW	5 1/2"	7 1/2"	2"	2 1/4"	1 1/2"	1.1 lbs.



Cast Door Pull No. 131-RKW

- Material:** Cast aluminum, brass, bronze, stainless steel
- Finishes:** Available in standard architectural finishes (see page 9)
- Fastener:** #8 x 3/4" OH SMS

No.	CTC	Overall	Base	Projection	Clearance	Weight
131-RKW	—	7 1/2"	2"	2 1/4"	1 1/2"	1.1 lbs.



Cast Door Pull No. 132-RKW

- Material:** Cast aluminum, brass, bronze, stainless steel
- Finishes:** Available in standard architectural finishes, and US32DMS (see page 9)
- Fastener:** 1/4 - 20 x 2 1/4" thru bolt & finish washer (standard 1 3/4" door)
- Options:**
- Advise if door thickness is other than 1 3/4"
 - See page B13 for mounting selection (standard duty 1/4 - 20)

No.	CTC	Overall	Base	Projection	Clearance	Weight
132-RKW	5 1/2"	6 3/8"	7/8"	1 7/8"	1 3/8"	0.8 lbs.



Security Loop Door Pull No. D133-RKW

- Material:** Brass, stainless steel
- Finishes:** US4, 10BE, US32D, and US32DMS
- Fastener:** 2 ea. 3/8 - 16 x 5/8" OH Security Torx MS

No.	CTC	Overall	Base	Projection	Clearance	Weight
D133-RKW	7 3/4"	8 3/4"	1 3/4" x 1 7/8"	2 1/4"	1 11/16"	1.1 lbs.



Cast Door Pull No. 134-RKW

- Material:** Cast brass
- Finishes:** Available in standard architectural finishes (see page 9)
- Fastener:** 1/4 - 20 x 2 1/4" thru bolt & finish washer (standard 1 3/4" door)
- Options:**
- Advise if door thickness is other than 1 3/4"
 - See page B13 for mounting selection (standard duty 1/4 - 20)

No.	CTC	Overall	Base	Projection	Clearance	Weight
134-RKW	7 1/2"	8 1/2"	1"	1 7/8"	1 3/8"	1.0 lbs.

ROCKWOOD[®]

ASSA ABLOY

Experience a safer
and more open world

800 458 2424 | www.rockwoodmfg.com
Check the web site for the up-to-date catalog

Copyright © 2012-2024, ASSA ABLOY Accessories and Door Controls Group, Inc. All rights reserved. Reproduction in whole or in part without the express written permission of ASSA ABLOY Accessories and Door Controls Group, Inc. is prohibited.



Cast Door Pull No. 137

Material: Cast brass, stainless steel

Finishes: Available in standard architectural finishes, and US32DMS (see page 9)

Fastener: 1/4 - 20 x 2 1/4" thru bolt & finish washer (standard 1 3/4" door)

Options:

- Advise if door thickness is other than 1 3/4"
- See page B13 for mounting selection (standard duty 1/4 - 20)

No.	CTC	Overall	Base	Projection	Clearance	Weight
137	5 1/2"	6"	5/8" x 1 1/4"	2"	1 1/2"	0.9 lbs.



Cast Door Pull No. 137L

Material: Cast brass, bronze

Finishes: Available in standard architectural finishes (see page 9)

Fastener: 1/4 - 20 x 2 1/4" thru bolt & finish washer (standard 1 3/4" door)

Options:

- Advise if door thickness is other than 1 3/4"
- See page B13 for mounting selection (standard duty 1/4 - 20)

No.	CTC	Overall	Base	Projection	Clearance	Weight
137L	10"	10 3/4"	5/8" x 1 1/4"	2 1/2"	1 3/4"	1.1 lbs.



Cast Door Pull No. 138

Material: Cast aluminum, brass

Finishes: Available in standard architectural finishes (see page 9)

Fastener: 1/4 - 20 x 2 1/4" thru bolt & finish washer (standard 1 3/4" door)

Options:

- Advise if door thickness is other than 1 3/4"
- See page B13 for mounting selection (standard duty 1/4 - 20)

No.	CTC	Overall	Base	Projection	Clearance	Weight
138	7 1/2"	9 1/2"	2"	2"	1 1/2"	1.5 lbs.



Cast Door Pull No. 139

Material: Cast aluminum, brass

Finishes: Available in standard architectural finishes (see page 9)

Fastener: #8 x 3/4" OH SMS

No.	CTC	Overall	Base	Projection	Clearance	Weight
139	—	9 1/2"	2"	2"	1 1/2"	1.5 lbs.



Door Pulls No. 147, 147L

Material: Cast brass.

Finishes: Available in standard architectural finishes (see page 9)

Fastener: 1/4 - 20 x 2 1/4" thru bolt & finish washer (standard 1 3/4" door)

Options: Elliptical base plates

- Options:**
- Advise if door thickness is other than 1 3/4"
 - See page B13 for mounting selection (standard duty 1/4 - 20)

No.	CTC	Overall	Base	Projection	Clearance	Weight
147	6"	7 1/2"	1 1/8" dia.	2 1/2"	1 3/4"	1.2 lbs.
147L	12"	13 3/4"	1 7/8" dia.	2 5/8"	1 7/8"	1.7 lbs.



Door Pull No. 148

Material: Cast brass

Finishes: Available in standard architectural finishes (see page 9)

Fastener: 1/4 - 20 x 2 1/4" thru bolt & finish washer (standard 1 3/4" door)

- Options:**
- Type 5 back to back mounting.
 - Advise if door thickness is other than 1 3/4".
 - See page B13 for mounting selection (standard duty 1/4 - 20).

No.	CTC	Overall	Base	Projection	Clearance	Weight
148	8"	8 7/8"	1 5/16"	2 1/4"	1 1/4"	1.5 lbs.



Door Pull No. 149

Material: Cast brass

Finishes: Available in standard architectural finishes (see page 9)

Fastener: 1/4 - 20 x 2 3/4" thru bolt & finish washer (standard 1 3/4" door)

- Options:**
- Type 5 back to back mounting
 - Advise if door thickness is other than 1 3/4"
 - See page B13 for mounting selection (standard duty 1/4 - 20)

No.	CTC	Overall	Base	Projection	Clearance	Weight
149	8"	9 1/4"	1 3/4"	2 5/8"	1 5/8"	1.8 lbs.

ROCKWOOD®

ASSA ABLOY

Experience a safer
and more open world

800 458 2424 | www.rockwoodmfg.com
Check the web site for the up-to-date catalog

Copyright © 2012-2024, ASSA ABLOY Accessories and Door Controls Group, Inc. All rights reserved. Reproduction in whole or in part without the express written permission of ASSA ABLOY Accessories and Door Controls Group, Inc. is prohibited.



Pull Plates No. 102 x 70, 105 x 70, 106 x 70, 107 x 70

Material: Aluminum, brass, bronze, stainless steel

Finishes: Stocked in standard architectural finishes but available in any finish, US32DMS and US32D316 (see page 9)

Fastener: #6 x 5/8" OH SMS; 1/4 - 20 x 2 1/4" thru bolt & finish washer (standard 1 3/4" door)

Options:

- Barrier Free available in 2 1/2" clearance — use BF prefix when ordering (BF102 x 70C)
- Advise if door thickness is other than 1 3/4"
- See page B13 for mounting selection (standard duty 1/4 - 20)

No.	Pull	CTC	Plate	Size	Weight
102x70B	5/8" dia.	5 1/2"	70	3 1/2" x 15"	1.8 lbs.
102x70C	5/8" dia.	5 1/2"	70	4" x 16"	1.9 lbs.
105x70B	3/4" dia.	5 1/2"	70	3 1/2" x 15"	2.1 lbs.
105x70C	3/4" dia.	5 1/2"	70	4" x 16"	2.2 lbs.
106x70B	3/4" dia.	6"	70	3 1/2" x 15"	2.2 lbs.
106x70C	3/4" dia.	6"	70	4" x 16"	2.3 lbs.
107x70B	3/4" dia.	8"	70	3 1/2" x 15"	2.4 lbs.
107x70C	3/4" dia.	8"	70	4" x 16"	2.5 lbs.



Pull Plates No. 110 x 70, 111 x 70

Material: Aluminum, brass, bronze, stainless steel

Finishes: Stocked in standard architectural finishes but available in any finish, US32DMS and US32D316 (see page 9)

Fastener: #6 x 5/8" OH SMS; 1/4 - 20 x 2 1/4" thru bolt & finish washer (standard 1 3/4" door)

Options:

- Barrier Free available in 2 1/2" clearance — use BF prefix when ordering (BF110 x 70C)
- Advise if door thickness is other than 1 3/4"
- See page B13 for mounting selection (standard duty 1/4 - 20)
- Heavy bevel available, specify HVBEV

No.	Pull	CTC	Plate	Size	Weight
110x70B	1" dia.	8"	70	3 1/2" x 15"	3.8 lbs.
110x70C	1" dia.	8"	70	4" x 16"	3.9 lbs.
111x70B	1" dia.	10"	70	3 1/2" x 15"	4.3 lbs.
111x70C	1" dia.	10"	70	4" x 16"	4.4 lbs.



Pull Plates No. 122 x 70, 123 x 70

- Material:** Aluminum, brass, stainless steel
- Finishes:** Stocked in standard architectural finishes but available in any finish (see page 9)
- Fastener:** #6 x 5/8" OH SMS; 1/4-20 x 2 1/4" thru bolt & finish washer (standard 1 3/4" door)
- Options:**
- Advise if door thickness is other than 1 3/4"
 - See page B13 for mounting selection (standard duty 1/4-20)
 - Heavy bevel available, specify HVBEV

No.	Pull	CTC	Plate	Size	Weight
122x70B	3/8" x 1 1/4"	6"	70	3 1/2" x 15"	2.2 lbs.
122x70C	3/8" x 1 1/4"	6"	70	4" x 16"	2.3 lbs.
123x70B	3/8" x 1 1/4"	8"	70	3 1/2" x 15"	2.5 lbs.
123x70C	3/8" x 1 1/4"	8"	70	4" x 16"	2.6 lbs.



Pull Plates No. 125 x 70, 126 x 70

- Material:** Aluminum, brass, bronze, stainless steel
- Finishes:** Stocked in standard architectural finishes but available in any finish (see page 9)
- Fastener:** #6 x 5/8" OH SMS; 1/4-20 x 2 1/4" thru bolt & finish washer (standard 1 3/4" door)
- Options:**
- Advise if door thickness is other than 1 3/4"
 - See page B13 for mounting selection (standard duty 1/4-20)
 - Heavy bevel available, specify HVBEV

No.	Pull	CTC	Plate	Size	Weight
125x70B	1" half round	6"	70	3 1/2" x 15"	2.0 lbs.
125x70C	1" half round	6"	70	4" x 16"	2.1 lbs.
126x70B	1" half round	8"	70	3 1/2" x 15"	2.3 lbs.
126x70C	1" half round	8"	70	4" x 16"	2.4 lbs.

ROCKWOOD®

ASSA ABLOY

Experience a safer
and more open world

800 458 2424 | www.rockwoodmfg.com
Check the web site for the up-to-date catalog

Copyright © 2012-2024, ASSA ABLOY Accessories and Door Controls Group, Inc. All rights reserved. Reproduction in whole or in part without the express written permission of ASSA ABLOY Accessories and Door Controls Group, Inc. is prohibited.



Pull Plates No. 132 x 70

Material: Aluminum, brass, bronze, stainless steel

Finishes: Stocked in standard architectural finishes but available in any finish, and US32DMS (see page 9)

Fastener: #6 x ⁵/₈" OH SMS; 1/4 - 20 x 2 1/4" thru bolt & finish washer (standard 1 3/4" door)

Options:

- Advise if door thickness is other than 1 3/4"
- See page B13 for mounting selection (standard duty 1/4 - 20)
- Heavy bevel available, specify HVBEV

No.	Pull	CTC	Plate	Size	Weight
132x70B	Cast	5 1/2"	70	3 1/2" x 15"	1.7 lbs.
132x70C	Cast	5 1/2"	70	4" x 16"	1.8 lbs.



Pull Plates No. 137 x 70

Material: Brass, stainless steel

Finishes: Stocked in standard architectural finishes but available in any finish (see page 9)

Fastener: #6 x ⁵/₈" OH SMS; 1/4 - 20 x 2 1/4" thru bolt & finish washer (standard 1 3/4" door)

Options:

- Advise if door thickness is other than 1 3/4"
- See page B13 for mounting selection (standard duty 1/4 - 20)
- Heavy bevel available, specify HVBEV

No.	Pull	CTC	Plate	Size	Weight
137x70B	Cast	5 1/2"	70	3 1/2" x 15"	1.7 lbs.
137x70C	Cast	5 1/2"	70	4" x 16"	1.8 lbs.

Pull Plates No. 147 x 76, 147 x 77

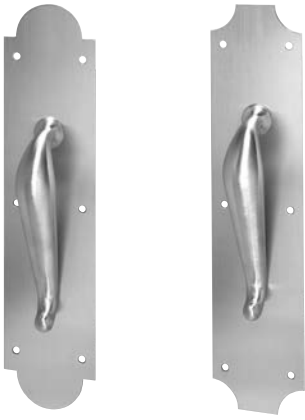

No. 147 x 76B

No. 147 x 77B

Material: Cast brass.

Finishes: Available in standard architectural finishes (see page 9)

Fastener: #6 x 5/8" OH SMS; 1/4-20 x 2 1/4" thru bolt & finish washer (standard 1 3/4" door)

Options:

- Advise if door thickness is other than 1 3/4"
- See page B13 for mounting selection (standard duty 1/4-20)

No.	Pull	CTC	Plate	Size	Weight
147x76B	Cast	6"	76	3 1/2" x 15"	2.1 lbs.
147x76C	Cast	6"	76	4" x 16"	2.2 lbs.
147x77B	Cast	6"	77	3 1/2" x 15"	2.1 lbs.
147x77C	Cast	6"	77	4" x 16"	2.2 lbs.



No. 148 x 76B

No. 148 x 77B

Pull Plates No. 148 x 76, 148 x 77

Material: Cast brass

Finishes: Available in standard architectural finishes (see page 9)

Fastener: #6 x 5/8" OH SMS; 1/4-20 x 2 1/4" thru bolt & finish washer (standard 1 3/4" door)

Options:

- Advise if door thickness is other than 1 3/4"
- See page B13 for mounting selection (standard duty 1/4-20)

No.	Pull	CTC	Plate	Size	Weight
148x76B	Cast	8"	76	3 1/2" x 15"	2.7 lbs.
148x76C	Cast	8"	76	4" x 16"	2.8 lbs.
148x77B	Cast	8"	77	3 1/2" x 15"	2.7 lbs.
148x77C	Cast	8"	77	4" x 16"	2.8 lbs.

ROCKWOOD®

ASSA ABLOY

Experience a safer
and more open world

800 458 2424 | www.rockwoodmfg.com
Check the web site for the up-to-date catalog

Copyright © 2012-2024, ASSA ABLOY Accessories and Door Controls Group, Inc. All rights reserved. Reproduction in whole or in part without the express written permission of ASSA ABLOY Accessories and Door Controls Group, Inc. is prohibited.

NOTE: Y base plates are recommended on wood or glass doors to make a stable and durable mounting.
 NOTE: Heavy Duty (HD/XHD) mounting features hex drive for positive tightening and large overall size for superior strength.
 Recommended for high frequency and rough service openings.

Thru Bolt

Wood or Metal Door - Type 1

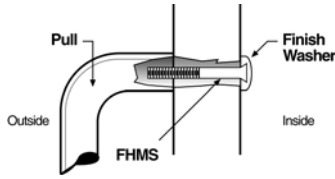

Type	Bolt Size	Drill Size	
		Wood	Metal
1	1/4 - 20	9/32	9/32
1HD	5/16 - 18	11/32	11/32
1XHD	3/8 - 16	13/32	13/32

Wood or Metal Door - Type 12

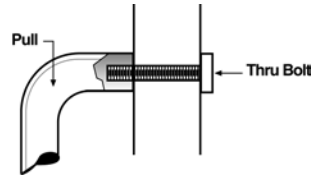

Type	Bolt Size	Drill Size	
		Wood	Metal
12	1/4 - 20	9/32	9/32
12HD	5/16 - 18	11/32	11/32
12XHD	3/8 - 16	13/32	13/32

Glass Door - Type 15

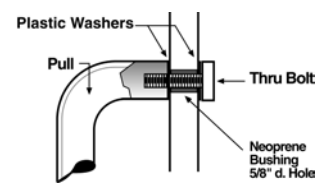

Type	Bolt Size	Drill Size
		Glass
15	1/4 - 20	5/8
15HD	5/16 - 18	5/8
15XHD	3/8 - 16	5/8

Back to Back

Wood or Metal Door - Type 16

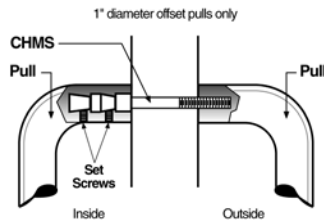

Type	Bolt Size	Drill Size	
		Wood	Metal
16	1/4 - 20	9/32	9/32
16HD	5/16 - 18	11/32	11/32

Glass Door - Type 18

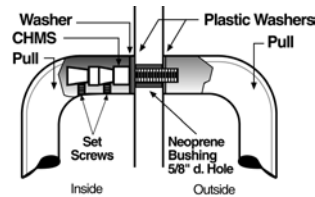

Type	Bolt Size	Drill Size
		Glass
18	1/4 - 20	5/8
18HD	5/16 - 18	5/8

Concealed

Metal Door - Type 17

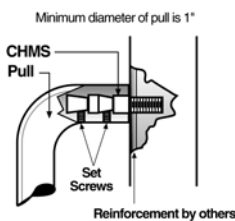

Type	Bolt Size	Drill Size
		Metal
17	1/4 - 20	1/4 - 20 tap
17HD	5/16 - 18	5/16 - 18 tap

Metal Door - Type 17R

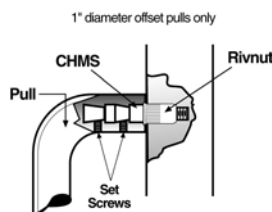

Type	Bolt Size	Drill Size
		Metal
17R	1/4 - 20	N/A

800 458 2424 | www.rockwoodmfg.com
 Check the web site for the up-to-date catalog

Copyright © 2012-2024, ASSA ABLOY Accessories and Door Controls Group, Inc. All rights reserved. Reproduction in whole or in part without the express written permission of ASSA ABLOY Accessories and Door Controls Group, Inc. is prohibited.

ROCKWOOD®
ASSA ABLOY

Experience a safer
 and more open world

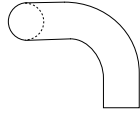

90° Offset Door Pulls No. BF150, BF151, BF152

Material: Aluminum, brass, bronze, stainless steel

Finishes: Available in standard architectural finishes, US32DMS, US32D316, US32316, white (WPC), red (RPC), and black (BPC) powder coat finishes (see page 9)

Fastener: 1/4-20 x 2 1/4" thru bolt & finish washer (standard 1 3/4" door)

- Options:**
- Back to back mounting in pairs – use BTB suffix and mounting type number (BF150BTB16)
 - Concealed mounting single pulls – use C suffix and mounting type number (BF150C17)
 - Advise if door thickness is other than 1 3/4"
 - See page B27 for mounting selection (standard duty 1/4-20)

No.	Material Size	CTC	Overall	Base	Projection	Clearance	Offset	Weight
BF150	3/4" dia.	8"	8 3/4"	3/4"	3 1/4"	2 1/2"	3"	2.3 lbs.
BF151	3/4" dia.	10"	10 3/4"	3/4"	3 1/4"	2 1/2"	3"	2.5 lbs.
BF152	3/4" dia.	12"	12 3/4"	3/4"	3 1/4"	2 1/2"	3"	2.7 lbs

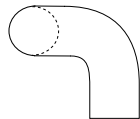
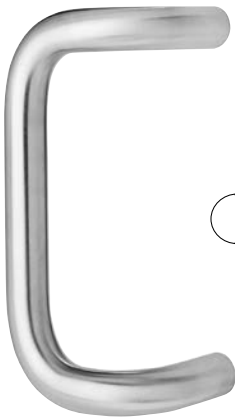

90° Offset Door Pulls No. BF156, BF157A, BF157, BF158, BF159

Material: Aluminum, brass, bronze, stainless steel

Finishes: Available in standard architectural finishes, US32DMS, US32D316, US32316, white (WPC), red (RPC), and black (BPC) powder coat finishes (see page 9)

Fastener: 1/4-20 x 2 1/4" thru bolt & finish washer (standard 1 3/4" door)

Features: Recommended for ADA openings

- Options:**
- Back to back mounting in pairs – use BTB suffix and mounting type number (BF156BTB16)
 - Concealed mounting single pulls – use C suffix and mounting type number (BF156C17)
 - Advise if door thickness is other than 1 3/4"
 - Heavy duty versions of most fastening types available – use suffix HD to fastening type number (BF156BTB16HD)
 - See page B27 for mounting selection (standard duty 1/4-20)

No.	Material Size	CTC	Overall	Base	Projection	Clearance	Offset	Weight
BF156	1" dia.	8"	9"	1"	3 1/2"	2 1/2"	4"	3.9 lbs.
BF157A	1" dia.	9"	10"	1"	3 1/2"	2 1/2"	4"	4.1 lbs.
BF157	1" dia.	10"	11"	1"	3 1/2"	2 1/2"	4"	4.3 lbs.
BF158	1" dia.	12"	13"	1"	3 1/2"	2 1/2"	4"	4.8 lbs.
BF159	1" dia.	18"	19"	1"	3 1/2"	2 1/2"	4"	6.5 lbs.

ROCKWOOD®

ASSA ABLOY

Experience a safer
and more open world

800 458 2424 | www.rockwoodmfg.com
Check the web site for the up-to-date catalog

Copyright © 2012-2024, ASSA ABLOY Accessories and Door Controls Group, Inc. All rights reserved. Reproduction in whole or in part without the express written permission of ASSA ABLOY Accessories and Door Controls Group, Inc. is prohibited.

T Series 1" Tubular Pulls

The Rockwood T Series diameter offset tubular pulls are made from sturdy .065" thick wall tubing. Solid brass or stainless steel inserts are brazed into the ends to provide a solid area for our guaranteed mounting systems.

Benefits of specifying the T Series push and pulls include:

- Tubular pulls weigh 25% less than their solid counterparts; this 75% weight reduction greatly reduces the environmental impact of harvesting material for their manufacture – a LEED certified building goal
- The lighter weight minimizes the risk of damage in shipping and handling
- The cost of most tubular pulls represents a significant savings over the equivalent solid model

Considering all the benefits, the T Series pulls offer an improved value without any quality sacrifice

T Series is also available in straight pulls (see page B15) and in both Series 47 push bars and push & pull bar sets (see pages A19–A21).

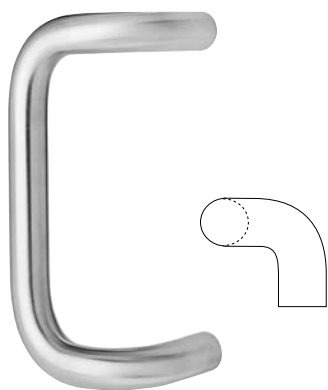

90° Offset Tubular Door Pulls

No. TBF156, TBF157A, TBF157, TBF158, TBF159

Material: Brass, bronze, stainless steel

Finishes: Available in standard architectural finishes (see page 9)

Fastener: 1/4" - 20 x 2 1/4" thru bolt & finish washer (standard 1 3/4" door)

Features: Recommended for ADA openings

- Options:**
- Back to back mounting in pairs – use BTB suffix and mounting type number (TBF156BTB16)
 - Concealed mounting single pulls – use C suffix and mounting type number (TBF156C17)
 - Advise if door thickness is other than 1 3/4"
 - See page B27 for mounting selection (standard duty 1/4" - 20)

No.	Material Size	CTC	Overall	Base	Projection	Clearance	Offset	Weight
TBF156	1" dia.	8"	9"	1"	3 1/2"	2 1/2"	4"	1.3 lbs.
TBF157A	1" dia.	9"	10"	1"	3 1/2"	2 1/2"	4"	1.4 lbs.
TBF157	1" dia.	10"	11"	1"	3 1/2"	2 1/2"	4"	1.4 lbs.
TBF158	1" dia.	12"	13"	1"	3 1/2"	2 1/2"	4"	1.5 lbs.
TBF159	1" dia.	18"	19"	1"	3 1/2"	2 1/2"	4"	1.5 lbs.

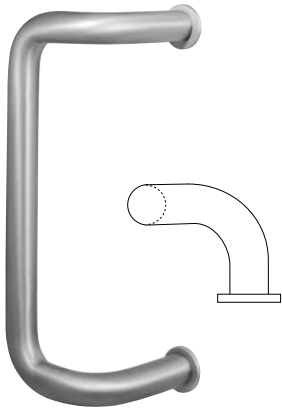

90° Offset Door Pulls with Base Plates

No. YBF150, YBF151, YBF152

Material: Aluminum, brass, bronze, stainless steel

Finishes: Available in standard architectural finishes, US32DMS, US32D316, US32316, white (WPC), red (RPC), and black (BPC) powder coat finishes (see page 9)

Fastener: 1/4 - 20 x 2 1/2" thru bolt & finish washer (standard 1 3/4" door)

Features: Base plates improve stability on all doors and are especially recommended for use on wood and glass doors

- Options:**
- Back to back mounting in pairs — use BTB suffix and mounting type number (YBF150BTB16)
 - Concealed mounting single pulls — use C suffix and mounting type number (YBF150C17)
 - Advise if door thickness is other than 1 3/4"
 - See page B27 for mounting selection (standard duty 1/4 - 20)

No.	Material Size	CTC	Overall	Base	Projection	Clearance	Offset	Weight
YBF150	3/4" dia.	8"	9 1/16"	1 1/16"	3 3/4"	2 5/8"	3"	2.4 lbs.
YBF151	3/4" dia.	10"	11 1/16"	1 1/16"	3 3/4"	2 5/8"	3"	2.6 lbs.
YBF152	3/4" dia.	12"	13 1/16"	1 1/16"	3 3/4"	2 5/8"	3"	2.8 lbs

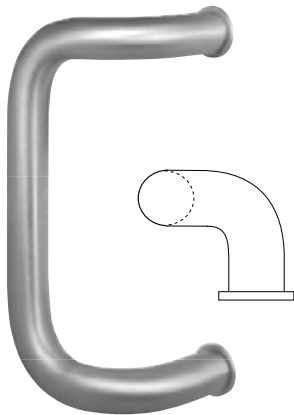

90° Offset Door Pulls with Base Plates

No. YBF156, YBF157A, YBF157, YBF158, YBF159

Material: Aluminum, brass, bronze, stainless steel.

Finishes: Available in standard architectural finishes, US32DMS, US32D316, US32316, white (WPC), red (RPC), and black (BPC) powder coat finishes (see page 9)

Fastener: 1/4 - 20 x 2 1/2" thru bolt & finish washer (standard 1 3/4" door)

Features:

- Recommended for ADA openings
- Base plates improve stability on all doors and are especially recommended for use on wood and glass doors

- Options:**
- Back to back mounting in pairs — use BTB suffix and mounting type number (YBF156BTB16)
 - Concealed mounting single pulls — use C suffix and mounting type number (YBF156C17)
 - Advise if door thickness is other than 1 3/4"
 - Heavy duty versions of most fastening types available — use suffix HD to fastening type number (YBF156BTB16HD)
 - See page B27 for mounting selection (standard duty 1/4 - 20)

No.	Material Size	CTC	Overall	Base	Projection	Clearance	Offset	Weight
YBF156	1" dia.	8"	9 1/4"	1 1/4"	3 5/8"	2 5/8"	4"	4.0 lbs.
YBF157A	1" dia.	9"	10 1/4"	1 1/4"	3 5/8"	2 5/8"	4"	4.2 lbs.
YBF157	1" dia.	10"	11 1/4"	1 1/4"	3 5/8"	2 5/8"	4"	4.4 lbs.
YBF158	1" dia.	12"	13 1/4"	1 1/4"	3 5/8"	2 5/8"	4"	4.9 lbs.
YBF159	1" dia.	18"	19 1/4"	1 1/4"	3 5/8"	2 5/8"	4"	6.6 lbs.

ROCKWOOD®

ASSA ABLOY

Experience a safer
and more open world

800 458 2424 | www.rockwoodmfg.com
Check the web site for the up-to-date catalog

Copyright © 2012-2024, ASSA ABLOY Accessories and Door Controls Group, Inc. All rights reserved. Reproduction in whole or in part without the express written permission of ASSA ABLOY Accessories and Door Controls Group, Inc. is prohibited.

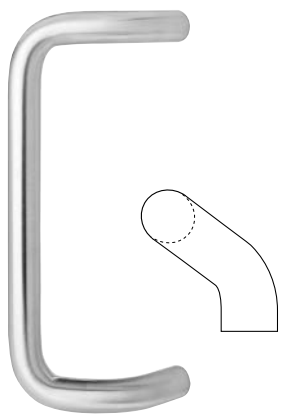

45° Offset Door Pulls No. BF160, BF161, BF162

Material: Aluminum, brass, bronze, stainless steel

Finishes: Available in standard architectural finishes, US32DMS, US32D316, US32316, white (WPC), red (RPC), and black (BPC) powder coat finishes (see page 9)

Fastener: 1/4" - 20 x 2 1/4" thru bolt & finish washer (standard 1 3/4" door)

Options:

- Back to back mounting in pairs – use BTB suffix and mounting type number (BF160BTB16)
- Concealed mounting single pulls – use C suffix and mounting type number (BF160C17)
- Advise if door thickness is other than 1 3/4"
- See page B27 for mounting selection (standard duty 1/4" - 20).
- Use Y prefix (YBF160) when ordering pulls with base plates, Y plate diameter is 1 1/16"; recommended for use on wood and glass doors

No.	Material Size	CTC	Overall	Base	Projection	Clearance	Offset	Weight
BF160	3/4" dia.	8"	8 3/4"	3/4"	3 1/4"	2 1/2"	2 1/4"	1.8 lbs.
BF161	3/4" dia.	10"	10 3/4"	3/4"	3 1/4"	2 1/2"	2 1/4"	2.0 lbs.
BF162	3/4" dia.	12"	12 3/4"	3/4"	3 1/4"	2 1/2"	2 1/4"	2.2 lbs.

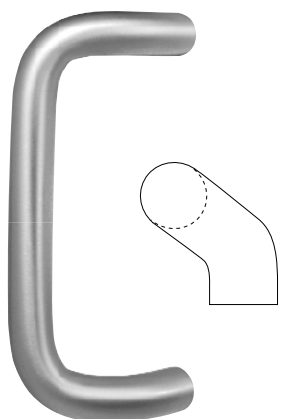

45° Offset Door Pulls No. BF166, BF167A, BF167, BF168, BF169

Material: Aluminum, brass, bronze, stainless steel

Finishes: Available in standard architectural finishes, US32DMS, US32D316, US32316, white (WPC), red (RPC), and black (BPC) powder coat finishes (see page 9)

Fastener: 1/4" - 20 x 2 1/4" thru bolt & finish washer (standard 1 3/4" door)

Options:

- Back to back mounting in pairs – use BTB suffix and mounting type number (BF166BTB16)
- Concealed mounting single pulls – use C suffix and mounting type number (BF166C17)
- Advise if door thickness is other than 1 3/4"
- Heavy duty versions of most fastening types available – use suffix HD to fastening type number (BF166BTB16HD)
- See page B27 for mounting selection (standard duty 1/4" - 20)
- Use Y prefix (YBF16) when ordering pulls with base plates, Y plate diameter is 1 1/4"; recommended for use on wood and glass doors

No.	Material Size	CTC	Overall	Base	Projection	Clearance	Offset	Weight
BF166	1" dia.	8"	9"	1"	3 1/2"	2 1/2"	2 3/4"	2.8 lbs.
BF167A	1" dia.	9"	10"	1"	3 1/2"	2 1/2"	2 3/4"	3.0 lbs.
BF167	1" dia.	10"	11"	1"	3 1/2"	2 1/2"	2 3/4"	3.2 lbs.
BF168	1" dia.	12"	13"	1"	3 1/2"	2 1/2"	2 3/4"	3.6 lbs.
BF169	1" dia.	18"	19"	1"	3 1/2"	2 1/2"	2 3/4"	5.0 lbs.

ROCKWOOD®

ASSA ABLOY

Experience a safer
and more open world



Offset Door Pull No. 185

- Material:** Aluminum, brass, bronze, stainless steel
- Finishes:** Available in standard architectural finishes, except US26 and US26D (see page 9)
- Fastener:** 1/4 - 20 x 2 1/4 thru bolt & finish washer (standard 1 3/4" door)
- Options:**
- Engraving "PUSH" or "PULL" or a corporate logo. Email artwork file for quicker service
 - Advise if door thickness is other than 1 3/4"
 - See page B27 for mounting selection (standard duty 1/2 - 20)

No.	Material Size	CTC	Base	Projection	Clearance	Weight
185	5" x 12"	10"	1" x 12"	2 3/8"	1 1/8"	12.5 lbs.



90° Offset Door Pull with Santoprene Grip No. BF195

- Material:** Aluminum
- Finishes:** Available in US28, 313, 314, 315, 10BE, BSP (Black Suede), WSP (White Suede), stock powder coat finishes (see page 9)
- Fastener:** 1/4 - 20 x 2 1/4" thru bolt & finish washer (standard 1 3/4" door)
- Features:** Santoprene™ durable weather resistant grip
Recommended for ADA openings
- Options:**
- Back to back mounting in pairs – use BTB suffix and mounting type number (BF195BTB16)
 - Concealed mounting single pulls – use C suffix and mounting type number (BF195C17)
 - Advise if door thickness is other than 1 3/4"
 - See page B13 for mounting selection (standard duty 1/4" - 20)

No.	Material Size	CTC	Overall	Base	Projection	Clearance	Offset	Weight
BF195	1" dia	18"	19"	1"	3 1/2"	2 1/2"	4"	6.7 lbs.

ROCKWOOD®

ASSA ABLOY

Experience a safer
and more open world

800 458 2424 | www.rockwoodmfg.com
Check the web site for the up-to-date catalog

Copyright © 2012-2024, ASSA ABLOY Accessories and Door Controls Group, Inc. All rights reserved. Reproduction in whole or in part without the express written permission of ASSA ABLOY Accessories and Door Controls Group, Inc. is prohibited.



90° Straight Door Pull with Santoprene Grip No. 190

- Material:** Aluminum
- Finishes:** Available in US28, 313, 314, 315, 10BE, BSP (Black Suede), WSP (White Suede), stock powder coat finishes (see page 9)
- Fastener:** 1/4" - 20 x 2 1/4" thru bolt & finish washer (standard 1 3/4" door)
- Features:** Santoprene™ durable weather resistant grip
- Options:**
- Back to back mounting in pairs — use BTB suffix and mounting types
 - Concealed mounting single pulls— use C suffix and mounting type number (190C6)
 - Advise if door thickness is other than 1 3/4"
 - See page B13 for mounting selection (standard duty 1/4" - 20)

No.	Material Size	CTC	Overall	Base	Projection	Clearance	Weight
190	1" dia	12"	13"	1"	3 1/2"	2"	3.2 lbs.



Wooden Door Pull No. 208

- Material:** Maple, oak, walnut, cherry (other woods available upon request)
- Finishes:** Brackets available in standard architectural finishes (see page 9)
Wood available in oiled or clear finish
- Fastener:** 1/4" - 20 x 2 1/4" thru bolt & finish washer (standard 1 3/4" door)
- Ordering:** Specify type of material, finish of wood, and finish of metal brackets
- Options:**
- Use Y prefix (Y208) when ordering pulls with base plates, Y plate diameter is 1 1/16"; recommended for use on glass or wood doors
 - Back to back mounting — use BTB suffix (208BTB) when ordering two pulls back to back. See page B27 for mounting details
 - Other sizes and shapes available; contact factory
 - Advise if door thickness is other than 1 3/4"

No.	Grip	CTC	Overall	Base	Projection	Clearance	Weight
208	1"	8"	15"	3/4" dia.	2 1/2"	1 3/4"	1.9 lbs.



Tapered Door Pulls No. 215, 215L

- Material:** Aluminum, brass, bronze, stainless steel.
- Finishes:** Available in standard architectural finishes, and US32DMS (see page 9)
- Fastener:** 1/4" - 20 x 2 1/4" thru bolt & finish washer (standard 1 3/4" door)
- Options:**
- Use Y prefix (Y215) when ordering pulls with base plates, Y plate diameter is 1 1/16"; recommended for use on glass or wood doors
 - Back to back mounting — use BTB suffix (215BTB) when ordering two pulls back to back. See page B27 for mounting details
 - Advise if door thickness is other than 1 3/4"

No.	Material Size	CTC	Overall	Base	Projection	Clearance	Weight
215	1" dia.	8"	16"	3/4" dia.	2 1/2"	1 1/2"	3.5 lbs.
215L	1 1/4" dia.	12"	28"	3/4" dia.	2 3/4"	1 1/2"	9.4 lbs.

ROCKWOOD®

ASSA ABLOY



Arm Pull with Plate No. AP1007

- Material:** Stainless steel
- Finishes:** US32D, US32DMS, 10BE, BSP, WSP
- Fastener:** #8 x 3/4" OH SMS, 3/8"-16 x 2 1/2" thru bolt & finish washer
- Features:** Groove on backside of pull to comfortably accept forearm.
Plate features rounded corners



No.	Pull	Projection	Clearance	Plate Size	Weight
AP1007	3/4" dia.	4"	2 ²⁵ / ₃₂ " at center of groove	4" x 16"	4 lbs. 5.7 oz.



Arm Pulls No. AP1140, AP1141

- Material:** 1/8" Thick stainless steel
- Finishes:** US32DMS, 10BE, BSP, WSP
- Fasteners:** #10 x 1 1/4" FH SMS
- Options:** Apply above existing door pull or as new application

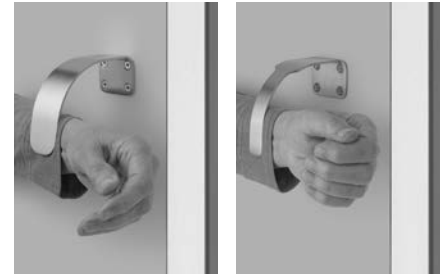

No.	Pull Width	Base Plate Width	Projection	Clearance	Weight
AP1140	1 1/2"	2"	4 1/2"	4 3/8"	6.4 oz.
AP1141	1 1/2" to 3/4"	2"	4 1/2"	4 3/8"	5 oz.



Hand/Arm Pull No. 193

- Material:** Cast brass, stainless steel
- Finishes:** US32D, US32DMS, US3, US4, US10, US10B, 10BE, BSP, WSP, US26, US26D
- Fasteners:** #8 x 3/4" OH SMS
- Options:** Use top portion as hand pull, use bottom portion as arm pull



No.	CTC	Overall	Projection	Clearance	Weight
193	5 ¹⁵ / ₁₆ "	9 1/4"	3 3/4"	1 ⁵ / ₈ "	0.9 lbs.

ROCKWOOD[®]

ASSA ABLOY

Experience a safer
and more open world

800 458 2424 | www.rockwoodmfg.com
Check the web site for the up-to-date catalog

Copyright © 2012–2024, ASSA ABLOY Accessories and Door Controls Group, Inc. All rights reserved. Reproduction in whole or in part without the express written permission of ASSA ABLOY Accessories and Door Controls Group, Inc. is prohibited.



Foot Pull No. FP1230

- Material:** $\frac{3}{16}$ " Thick stainless steel
- Finishes:** US32D, US32DMS, 10BE, BSP, WSP
- Fastener:** $\frac{1}{4}$ -20 x 1" FH MS
- Features:** Grip on top of pull for ease of use.
- Options:** Place your foot on top grip and pull the door open or put your toe underneath and pull the door towards you.



No.	CTC	Projection	Clearance	Weight
FP1230	6"	$3\frac{1}{4}$ "	$3\frac{1}{16}$ "	1 lbs. 1.3 oz.



Door Holder/Foot Pull No. 494-RKW

- Material:** Cast brass
- Finishes:** Available in standard architectural finishes (see page 9)
- Other:** Holder base: 3"w x $3\frac{3}{8}$ "h
- Holder Projection:** $2\frac{1}{8}$ "
- Strike Base** 2"w x 3"h
- Strike Projection:** $3\frac{1}{4}$ "
- Options:** Install strike on the bottom of the door to use as a foot pull. Mount the holder to the wall adjacent to the strike and utilize as a door holder.



No.	Fastener	Strike	Weight
494-RKW	Strike: 3 ea. #12 x $1\frac{1}{4}$ " FH WS, 3 ea. Plastic anchors Body: 4 ea. #10 x $1\frac{1}{4}$ " FH WS	Door	1.7 lbs.

NOTE: 494-RKW can be used as an Automatic Door Holder with Stop, see page D17.

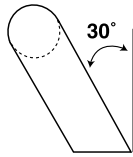

Heavy Duty Offset Door Pulls No. BF257, BF258, BF259, BF260

Material: Aluminum, brass, bronze, stainless steel

Finishes: Available in standard architectural finishes, US32DMS, US32D316, US32316, white (WPC), red (RPC), and black (BPC) powder coat finishes (see page 6)

Fastener: $\frac{3}{8}$ - 16 x 2 $\frac{1}{2}$ " thru bolt & finish washer (standard 1 $\frac{3}{4}$ " door)

Features:

- Heavy duty pull and mounting for rough service areas
- Large footprint on door provides stable mounting

Options:

- Advise if door thickness is other than 1 $\frac{3}{4}$ "

No.	Material Size	CTC	Overall	Base	Projection	Clearance	Offset	Weight
BF257	1 $\frac{1}{4}$ " dia.	10"	11 $\frac{1}{4}$ "	1 $\frac{1}{4}$ " x 1 $\frac{7}{16}$ "	3 $\frac{3}{4}$ "	2 $\frac{1}{2}$ "	2 $\frac{15}{16}$ "	8.3 lbs.
BF258	1 $\frac{1}{4}$ " dia.	12"	13 $\frac{1}{4}$ "	1 $\frac{1}{4}$ " x 1 $\frac{7}{16}$ "	3 $\frac{3}{4}$ "	2 $\frac{1}{2}$ "	2 $\frac{15}{16}$ "	9.0 lbs.
BF259	1 $\frac{1}{4}$ " dia.	18"	19 $\frac{1}{4}$ "	1 $\frac{1}{4}$ " x 1 $\frac{7}{16}$ "	3 $\frac{3}{4}$ "	2 $\frac{1}{2}$ "	2 $\frac{15}{16}$ "	11.1 lbs.
BF260	1 $\frac{1}{4}$ " dia.	24"	25 $\frac{1}{4}$ "	1 $\frac{1}{4}$ " x 1 $\frac{7}{16}$ "	3 $\frac{3}{4}$ "	2 $\frac{1}{2}$ "	2 $\frac{15}{16}$ "	13.3 lbs.



No. VRT12

Vandal Resistant Trim No. VRT12, VRT22

Material: Stainless steel

Finishes: VRT12 - US32D, US32DMS 10BE, Stock Powder Coats
VRT22 - US32D

Fastener: $\frac{1}{4}$ - 20 thru bolt. Other sizes to match locks and exit devices as required

Features: VRT22 – soft black textured grip

Options:

- Cut for cylinder – use C suffix (VRT22C) when ordering
- Specify make and model number of exit device when mounting with exit device fastening systems

No.	Material Size	Weight
VRT12	5 $\frac{7}{8}$ " x 12"	2.3 lbs.
VRT22	5 $\frac{7}{8}$ " x 12"	2.3 lbs.



No. VRT22

ROCKWOOD®

ASSA ABLOY

Experience a safer
and more open world

800 458 2424 | www.rockwoodmfg.com
Check the web site for the up-to-date catalog

Copyright © 2012–2024, ASSA ABLOY Accessories and Door Controls Group, Inc. All rights reserved. Reproduction in whole or in part without the express written permission of ASSA ABLOY Accessories and Door Controls Group, Inc. is prohibited.



No. VRT14



No. VRT16



No. VRT24



No. VRT26

Vandal Resistant Trim

No. VRT14, VRT16, VRT24, VRT26

Material: Stainless Steel

Finishes: VRT14 & VRT16 - US32D, US32DMS, 10BE,
Stock Powder Coats VRT24 & VRT26 - US32D

Fastener: 1/4 -20 Thru Bolt. Other sizes to match locks and exit devices as required

- Features:**
- Ideal pull for the exterior doors on schools and other public buildings, as well as the rear exit doors of commercial and industrial buildings
 - Vandal Resistant design minimizes opportunity for tampering
 - No exposed fasteners
 - Supplied with thru bolts for non-integrated mounting or can be supplied with mounting points to mate with exit device or mortise lock
 - US Patent No.: D659,507S

- Options:**
- Cut for cylinder use C suffix (VRT24C) when ordering
 - Specify make and model number of exit device when mounting with exit device fastening systems

No.	Integral Latch Guard	Textured Black Grip	Overall	Weight
VRT14	Yes	No	1/8" x 7" x 12"	3.2 lbs.
VRT16	No	No	1/8" x 5 1/2" x 12"	2.5 lbs.
VRT24	Yes	Yes	1/8" x 7" x 12"	3.2 lbs.
VRT26	No	Yes	1/8" x 5 1/2" x 12"	2.5 lbs.

Required Order Information (Please supply all required templates - mating parts and cylinders).

Quantity	Product #	Mating Manufacturer	Mating Part #	Device Template #	Template # for Cylinder Hole Location	Cylinder Diameter	Door Handing	Finish

Vandal Resistant Pull No. VRP 30



Material: 4" x 16" High Strength Steel

Weight: 3.25 lbs.

Finishes: 10BE, Stock Powder Coats, US32D, US32DMS

Fastener: #8 x 3/4" Oval Head Sheet Metal Screws

- Features:**
- Narrow, sloping handle for easy grip and reducing binding opportunities between handles.
 - High strength steel designed for durability and resisting vandalism.
 - Non handed design, reduces risk of installing incorrectly.
 - Backing plate included, removes necessity to repaint opening in retrofit applications.
 - Patented

- Options:**
- Engraving
 - Custom Powder Coat Available
 - Cylinder Option
 - For Mounting with Exit Device: Specify make and model number of exit device and send template when ordering.

Required Order Information (Please supply all required templates - mating parts and cylinders).

Quantity	Product #	Mating Manufacturer	Mating Part #	Device Template #	Template # for Cylinder Hole Location	Cylinder Diameter	Finish

ROCKWOOD®

ASSA ABLOY

Experience a safer and more open world

800 458 2424 | www.rockwoodmfg.com
Check the web site for the up-to-date catalog

Copyright © 2012-2024, ASSA ABLOY Accessories and Door Controls Group, Inc. All rights reserved. Reproduction in whole or in part without the express written permission of ASSA ABLOY Accessories and Door Controls Group, Inc. is prohibited.

Rockwood Vandal Resistant Order Form

Complete this form and email to: orders.rockwood@assaabloy.com / or fax to: 800.922.9212

Customer Information

Company Name: _____ Date: _____

Account #: _____ Phone/Fax: _____ / _____

Email: _____ PO #: _____ Line #: _____

* Cylinder Prep optional - Use C suffix (ex: VRT12C) when ordering.

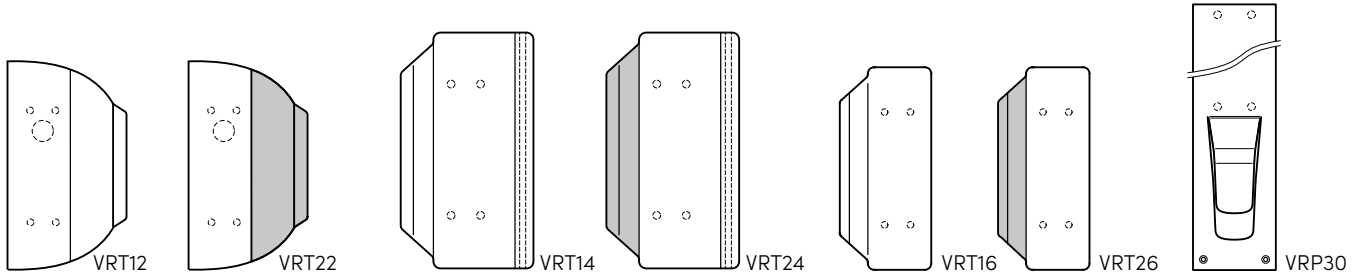

Vandal Resistant Products can be ordered to mount with an exit device, or in conjunction with a mortise lock. Include exit device and mortise lock templates when ordering. (If not being paired with either, please advise.) Stud locations shown above are an indication that an exit device can be mated to these pulls. This is not indicating a standard pattern of these studs, we can custom manufacture the pull to the exit device required.

No.	Integral Latch Guard	Textured Black Grip	Size	Weight
VRT12	No	No	5 7/8" x 12"	2.3 lbs
VRT22	No	Yes	5 7/8" x 12"	2.3 lbs
VRT14	Yes	No	6 3/4" x 12"	3.2 lbs
VRT24	Yes	Yes	6 3/4" x 12"	3.2 lbs
VRT16	No	No	5 3/8" x 12"	2.5 lbs
VRT26	No	Yes	5 3/8" x 12"	2.5 lbs
VRP30	N/A	No	4" x 16" - 2 1/16" Proj.	3.25 lbs

Required Order Information (Please supply all required templates)

Qty	Rockwood Product #	Mating Device Manufacturer	Mating Device Product #	Device Template #	Template # for Cylinder Hole Loc.	Cylinder Dia.	Door Handing	Finish

Finish Options:

VRT22, VRT24, VRT26: US32D/630

VRT12, VRT14, VRT16, VRP30: US32D/630 US32DMS 10BE Stock Powder Coats (specify): _____

NOTE: Orders will not be processed until all Templates have been received.

NOTE: Mounting hardware is not provided for VRT to attach with exit device.

Your signature indicates the information contained on this order form is accurate and ready to be manufactured.

(customer signature)

(date)

ROCKWOOD®

ASSA ABLOY

800 458 2424 | www.rockwoodmfg.com
Check the web site for the up-to-date catalog

Copyright © 2012-2024, ASSA ABLOY Accessories and Door Controls Group, Inc. All rights reserved. Reproduction in whole or in part without the express written permission of ASSA ABLOY Accessories and Door Controls Group, Inc. is prohibited.

Experience a safer
and more open world **B39**

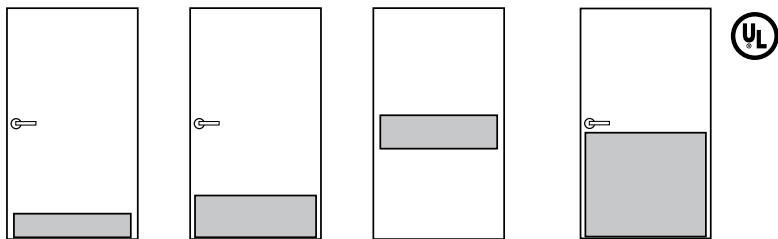
**Mop Plate**

Up to 6" h x 48" w

Kick Plate

6" to 12" h x 48" w

Stretcher Plate

6" to 12" h and up to 48" w

Armor Plate

Up to 48" h x 48" w and available in most finishes

**Width of Plates:**

Push Side: 2" less than door width.

Pull Side: 1½" less than door width.

NFPA 80 STANDARDS – 2-4.5 Protection

Plates: Factory-installed protection plates shall be installed in accordance with the listing of the door. Field-installed protection plates shall be labeled and installed in accordance with their listing.

Exception: Labeling is not required where the top of the protection plate is not more than 16" (406 mm) above the bottom of the door.

OPTIONAL Self-Drilling TEK Screws: Cuts door plate installation time in half.

Metal Door Plate – Economy Duty No. K1038

Material: .038" stainless steel**Finishes:** US32D**Fastener:** #6 x 5/8" OH SMS**Ordering:** Specify height x width x finish code. Add any options**Weight:** 8" x 34" = 3.2 lbs**Features:**

- All edges come beveled

Options:

- SA – self-adhesive mounting
- TORX – security Torx screws
- TEK – self-drilling screws
- Cutouts for locks, louvers, or windows (see worksheets on pages C14-C15 for details on how to order)

Metal Door Plate – Standard Duty No. K1050

Material: .050" Stainless Steel**Finishes:** US32D**Fastener:** #6 x 5/8" OH SMS**Features:**

- All edges come beveled

Options:

- One day shipping available
- Door markings are not available on quick ship

Metal Door Plate – Standard Duty No. K1050, K1050F

Material: .050" aluminum, brass, bronze, stainless steel**Finishes:** 10BE, US32D, US32DMS**Fastener:** #6 x 5/8" OH SMS**Ordering:** Specify height x width x finish code. Add any options**Weight:** 8" x 34" = 4.0 lbs**Features:**

- All edges come beveled

Options:

- SA – self-adhesive mounting
- TEK – self-drilling screws
- Cutouts for locks, louvers, or windows (see worksheets on pages C14-C15 for details on how to order)
- Heavy bevel available, specify HVBEV
- Screw mounting (K1050F) and UL listed for use on 90-minute label wood doors and 3-hour label metal doors
- CSK – countersunk holes
- TORX – security Torx screws



Windstorm Plate – K1050WS

Material: .050" Aluminium, Brass, Bronze, Stainless Steel**Finishes:** Standard Architectural Finishes**Fastener:** #10 x 5/8" Pan Head Tek Screws**Ordering:** Part # when ordering is K1050WS

All plates are UL and Windstorm rated

Features:

- All edges come beveled

Options:

- Cutouts for locks, louvers or windows
- Rounded Corners
- Heavy Bevel
- Screw Mount only



Certified to the below standards:

– ICC-500 (2014)

– FEMA Guideline 320 (2014)

– FEMA Guideline 361 (2015)

Part of windstorm assembly cards: ZHLA.45, ZHLA.46, ZHLA.47, ZHLA.51, ZHLA.53, ZHLA.54

800 458 2424 | www.rockwoodmfg.com

Check the web site for the up-to-date catalog

Copyright © 2012-2024, ASSA ABLOY Accessories and Door Controls Group, Inc. All rights reserved. Reproduction in whole or in part without the express written permission of ASSA ABLOY Accessories and Door Controls Group, Inc. is prohibited.

ROCKWOOD®**ASSA ABLOY**Experience a safer
and more open world

Shaped Metal Door Plates – Standard Duty No. K1050-1 thru K1050-8

Material: .050" stainless steel

Finishes: US32, US32D, US32DMS

Fastener: #6 x 5/8" OH SMS

Ordering: Specify height x width x finish code. Add any options

Weight: 8" x 34" = 4.0 lbs

Features: • All edges come beveled

Options:

- TEK – self-drilling screws
- CSK – countersunk holes
- Cutouts for locks, louvers, or windows (see worksheets on pages C14–C15 for details on how to order)
- TORX – security Torx screws
- Screw mounting (K1050F) and UL listed for use on 90-minute label wood doors and 3-hour label metal doors
- Any design is possible. Submit your drawings for a custom quote

No. K1050-1

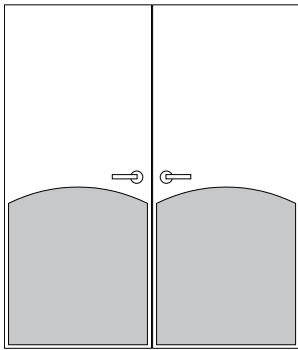

No. K1050-2

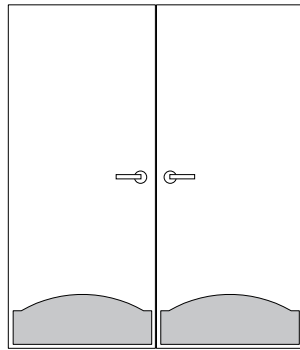

No. K1050-3

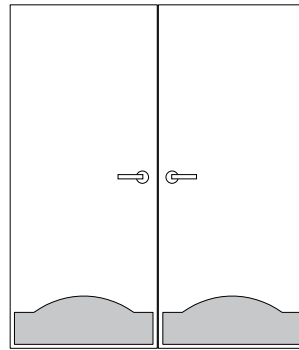

No. K1050-4

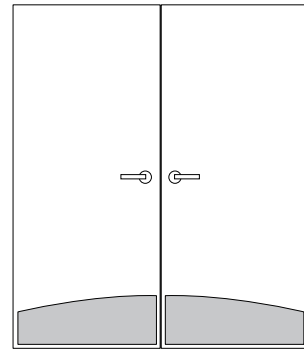

No. K1050-5

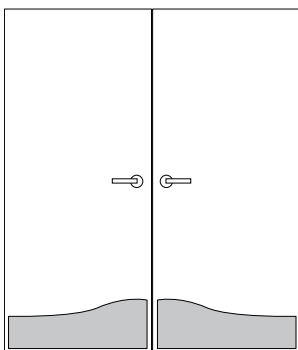

No. K1050-6

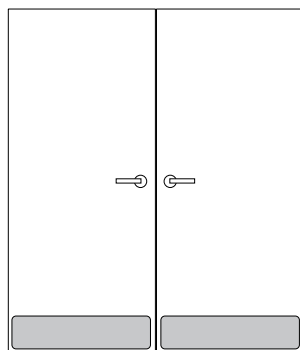

No. K1050-7

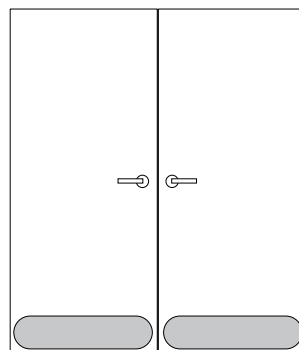

No. K1050-8

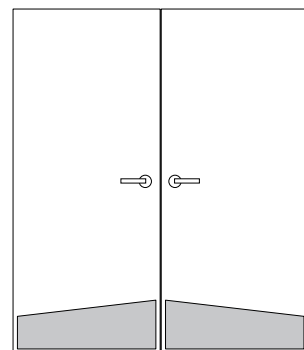

ROCKWOOD®

ASSA ABLOY

Experience a safer
and more open world

800 458 2424 | www.rockwoodmfg.com
Check the web site for the up-to-date catalog

Copyright © 2012–2024, ASSA ABLOY Accessories and Door Controls Group, Inc. All rights reserved. Reproduction in whole or in part without the express written permission of ASSA ABLOY Accessories and Door Controls Group, Inc. is prohibited.

Shaped Metal Armor Plates – Standard Duty No. K1050A-1 thru K1050A-8

Material: .050" stainless steel

Finishes: US32, US32D, US32DMS

Fastener: #6 x 5/8" OH SMS

Ordering: Specify height x width x finish code. Add any options

Weight: 36" x 34" = 18 lbs

Features: • All edges come beveled

Options:

- TEK – self-drilling screws
- CSK – countersunk holes
- Cutouts for locks, louvers, or windows (see worksheets on pages C14–C15 for details on how to order)
- TORX – security Torx screws
- Screw mounting (K1050F) and UL listed for use on 90-minute label wood doors and 3-hour label metal doors
- Any design is possible. Submit your drawings for a custom quote

No. K1050A-1

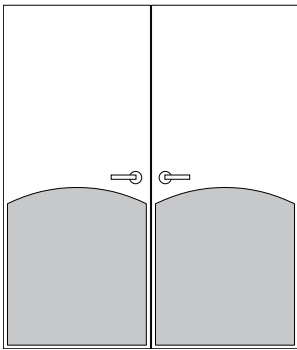

No. K1050A-2

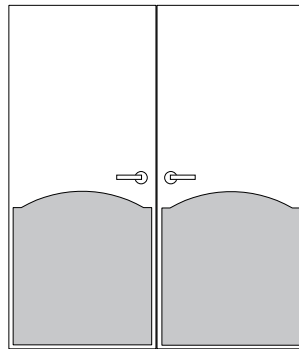

No. K1050A-3

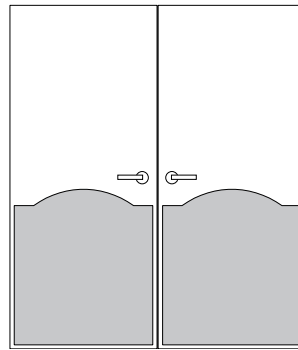

No. K1050A-4

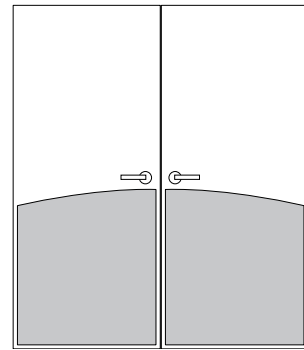

No. K1050A-5

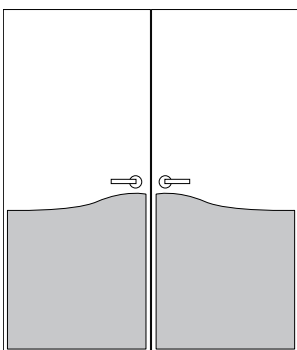

No. K1050A-6

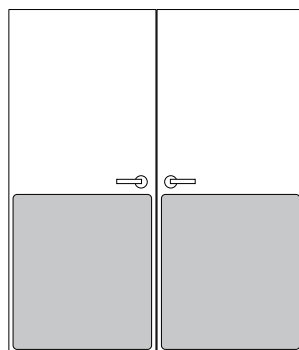

No. K1050A-7

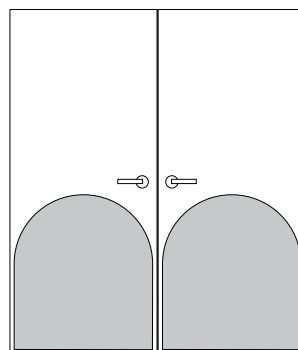

No. K1050A-8

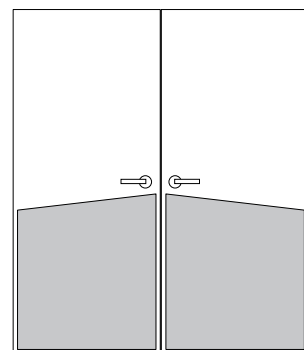

800 458 2424 | www.rockwoodmfg.com

Check the web site for the up-to-date catalog

Copyright © 2012–2024, ASSA ABLOY Accessories and Door Controls Group, Inc. All rights reserved. Reproduction in whole or in part without the express written permission of ASSA ABLOY Accessories and Door Controls Group, Inc. is prohibited.

ROCKWOOD®

ASSA ABLOY

Experience a safer
and more open world

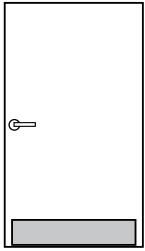

Mop Plate
Up to 6" h x 48" w

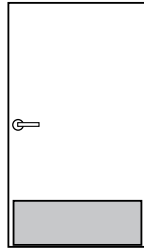

Kick Plate
6" to 12" h x 48" w

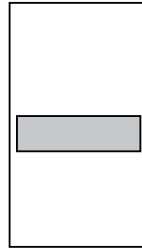

Stretcher Plate
6" to 12" h and up to 48" w

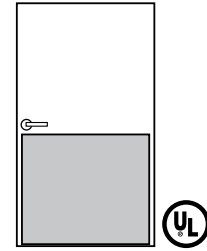

Armor Plate
Up to 48" h x 48" w and
available in most finishes

Width of Plates:

Push side: 2" less than door width. Pull side: 1½" less than door width.

Metal Door Plate – Heavy Duty No. K1062

Material: .062" stainless steel

Finishes: 10BE, US32D, US32DMS, BSP, WSP

Fastener: #6 x 5/8" OH SMS

Ordering: Specify height x width x finish code. Add any options

Weight: 8" x 34" = 5.0 lbs

Features

- All edges come beveled

Options:

- TEK – self-drilling screws
- CSK – countersunk holes
- Cutouts for locks, louvers, or windows (see worksheets on pages C14–C15 for details on how to order)
- TORX – security Torx screws
- Heavy bevel available, specify HVBEV

Metal Door Plate – Extra Heavy Duty No. K1125

Material: .125" aluminum, brass, bronze, stainless steel

Finishes: Available in standard architectural finishes, US32D**316** (see page 9)

Fastener: #6 x 5/8" OH SMS

Ordering: Specify height x width x finish code. Add any options

Weight: 8" x 34" = 10.0 lbs

Features

- All edges come beveled (not applicable on Aluminum Diamond Plate)

Options:

- TEK – self-drilling screws
- Cutouts for locks, louvers, or windows (see worksheets on pages C14–C15 for details on how to order)
- TORX – security Torx screws

Metal Door Plate – Extra Heavy Duty Diamond Plate No. K1125 DIA

Material: .125" aluminum

Finishes: Polished aluminum diamond plate (ALM DIA)

Fastener: #6 x 5/8" OH SMS

Ordering: Specify height x width x finish code. Add any options

Weight: 8" x 34" = 10.0 lbs

Options:

- TEK – self-drilling screws
- Cutouts for locks, louvers, or windows (see worksheets on pages C14–C15 for details on how to order)
- TORX – security Torx screws



ALM DIA
Polished Aluminum
Diamond Plate

ROCKWOOD®

ASSA ABLOY

Experience a safer
and more open world

800 458 2424 | www.rockwoodmfg.com
Check the web site for the up-to-date catalog

Copyright © 2012–2024, ASSA ABLOY Accessories and Door Controls Group, Inc. All rights reserved. Reproduction in whole or in part without the express written permission of ASSA ABLOY Accessories and Door Controls Group, Inc. is prohibited.

Plastic Door Plate - Heavy Duty No. K2060

Material: .060" Kydex® 160 PVC acrylic alloy plastic*

Finishes: Beige #72005, calcutta black #52000, chocolate brown #72010, pewter gray #52001

Fastener: #6 x 3/4" TH SMS

Ordering: Specify height x width x color. Add any options

Weight: 8" x 34" = 1.0 lbs

Options:

- Cutouts for locks, louvers, or windows (see worksheets on pages C14-C15 for details on how to order)
- SA – self-adhesive mounting (K2060SA)
- SA-F – self-adhesive mounting (K2060SA-F) and UL approved for use of 90-minute wood doors and 3-hour metal doors



Plastic Door Plate – Extra Heavy Duty No. K2125

Material: .125" Kydex® 160 PVC acrylic alloy plastic*

Finishes: Beige #72005, calcutta black #52000, chocolate brown #72010, pewter gray #52001

Fastener: #6 x 3/4" TH SMS

Ordering: Specify height x width x color. Add any options

Weight: 8" x 34" = 1.8 lbs

Options:

- Cutouts for locks, louvers, or windows (see worksheets on pages C14-C15 for details on how to order)
- CSK – countersunk holes

* Kydex 160 meets Class 1A building code ratings up to .060" thick.

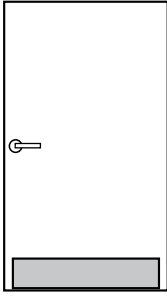
**Mop Plate**

Up to 6" h x 48" w

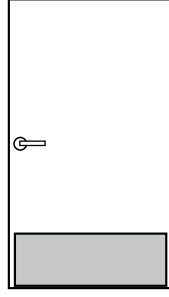
**Kick Plate**

6" to 12" h x 48" w

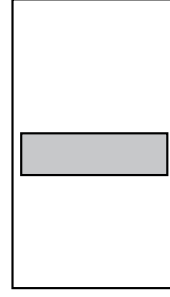
**Stretcher Plate**

6" to 12" h and up to 48" w

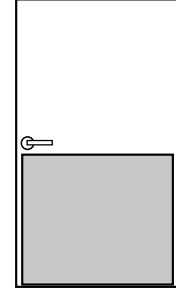
**Armor Plate**

Up to 48" h x 48" w

Width of Plates:

Push side: 2" less than door width. Pull side: 1½" less than door width.

Laminate Plastic Door Plate No. K3125

Material: .125" laminate plastic**Finishes:** Beige, black, brown, pewter gray, white**Fastener:** #6 x ¾" TH SMS**Ordering:** Specify height x width x finish code x color. Add any options**Weight:** 8" x 34" = 1.8 lbs

Options:

- SA – self-adhesive mounting (K3125SA)
- Cutouts for locks, louvers, or windows (see worksheets on pages C14–C15 for details on how to order)
- CSK – countersunk holes

Clear Plastic Door Plate No. K4125

Material: .125" clear plastic**Finishes:** Clear**Fastener:** #6 x ¾" TH SMS**Features:** Break and scratch resistant**Ordering:** Specify height x width. Add any options**Weight:** 8" x 34" = 1.5 lbs

Options:

- Cutouts for locks, louvers, or windows (see worksheets on pages C14–C15 for details on how to order)
- CSK – countersunk holes

ROCKWOOD®**ASSA ABLOY**Experience a safer
and more open world800 458 2424 | www.rockwoodmfg.com
Check the web site for the up-to-date catalog

Copyright © 2012–2024, ASSA ABLOY Accessories and Door Controls Group, Inc. All rights reserved. Reproduction in whole or in part without the express written permission of ASSA ABLOY Accessories and Door Controls Group, Inc. is prohibited.

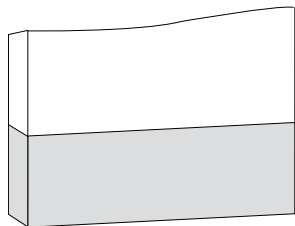

One-Sided Angle Plate No. KB1150

Material: .050" aluminum, brass, bronze, stainless steel

Finishes: Available in standard architectural finishes (see page 9)

Fastener: #6 x 5/8" FH/OH SMS

Ordering: Provide drawing specifying size, and square or bevel edge door

- 87 degrees – Pull side of beveled door
- 90 degrees – Push/Pull side of square door
- 93 degrees – Push side of beveled door

Options:

- Beveling, TORX – security Torx screws
- TEK – self-drilling screws
- Cutouts for hinges, flush bolts, and locks
- UL Listed (screw applied)

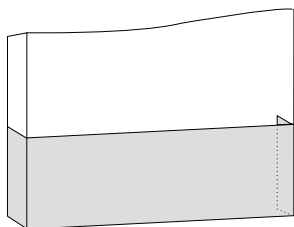

Two-Sided Angle Plate No. KB1151

Material: .050" aluminum, brass, bronze, stainless steel

Finishes: Available in standard architectural finishes (see page 9)

Fastener: #6 x 5/8" FH/OH SMS

Ordering: Provide drawing specifying size, and square or bevel edge door

- Both 90 degree bends on push or pull side of square door
- Both 93 degree bends on push side of beveled door
- One 90 degree bend and One 93 degree bend on push side of beveled/ square door
- Both 87 degree bends on pull side beveled door
- One 90 degree bend and One 87 degree bend on pull side of beveled/ square door

Options:

- Beveling, TORX – security Torx screws
- TEK – self-drilling screws
- Cutouts for hinges, flush bolts, and locks
- UL Listed (screw applied)

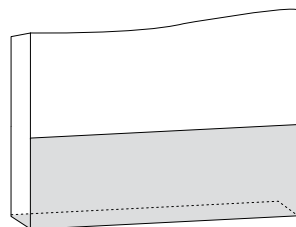

Bottom Angle Plate No. KB1152

Material: .050" aluminum, brass, bronze, stainless steel

Finishes: Available in standard architectural finishes (see page 9)

Fastener: #6 x 5/8" FH/OH SMS

Ordering: Provide drawing specifying size, and square or bevel edge door

- Always 90 degree bends

Options:

- Beveling, TORX – security Torx screws
- TEK – self-drilling screws
- UL Listed (screw applied)

Mortise Door Edges No. 300, 301, 302, 302B

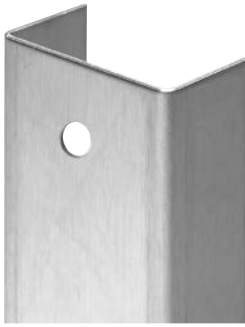

- Material:** .050" brass, bronze, stainless steel
- Finishes:** Available in standard architectural finishes, US32D**MS**, US32D**316**, prime painted steel (see page 9)
- Fastener:** #6 x 5/8" FH SMS
- Ordering:** Specify any length up to 96" (standard lengths are 42", 84", 96")
NOTE: 84" and 96" are made to match net door height – specify.
- Features:** Door edges are sized to be mortised into the surface of 1 3/4" thick wood doors. Advise if your door is another thickness
NOTE: Some wood doors that are nominally 1 3/4" vary significantly.
- Options:**
- UL fire rated listed for stainless steel, brass and bronze. For use on wood or plastic faced fire doors rated up to and including 1 1/2 hours or hollow metal, steel covered, composite type fire doors rated up to and including 3 hours. Specify UL when ordering (300-UL)
 - Cutouts for flush bolts, lock strikes, locks, and hinges (see worksheets on pages C10-C11 or C13-C15 for details on how to order)

NOTE: Your door thickness is a nominal dimension. Doors can vary + or - 1/16" from the nominal dimension. When ordering, verify actual door thickness to assure a working fit of the door edge.

No. 300

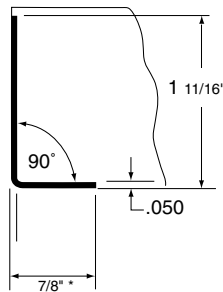

No. 301

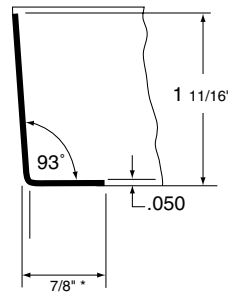

No. 302

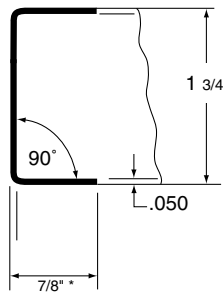

No. 302B

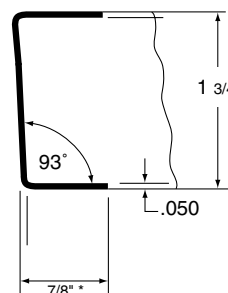

* Modified leg lengths available.

ROCKWOOD

ASSA ABLOY

Experience a safer and more open world

800 458 2424 | www.rockwoodmfg.com
 Check the web site for the up-to-date catalog

Copyright © 2012-2024, ASSA ABLOY Accessories and Door Controls Group, Inc. All rights reserved. Reproduction in whole or in part without the express written permission of ASSA ABLOY Accessories and Door Controls Group, Inc. is prohibited.



Non-Mortise Door Edges

No. 304, 305, 306-RKW, 306-AST, 306B, 306B-AST, 307



Material: .050" brass, bronze, stainless steel

Finishes: Available in standard architectural finishes, US32D**MS**, US32D**316**, prime painted steel (see page 9)

Fastener: #6 x 5/8" FH SMS

Features: • Door edges are sized for 1 3/4" thick wood or metal doors. Advise if your door is another thickness

NOTE: Some wood doors that are nominally 1 3/4" vary significantly.

• 306-AST and 306B-AST include an astragal, providing additional protection against vandalism

Ordering: Specify any length up to 96" (standard lengths are 42", 84", 96")

NOTE: 84" and 96" are made to match net door height – specify.

Specify wood or metal door

Options: • UL fire rated listed for stainless steel, brass and bronze. For use on wood or plastic faced fire doors rated up to and including 1 1/2 hours or hollow metal, steel covered, composite type fire doors rated up to and including 3 hours. Specify UL when ordering (306-UL)

• Cutouts for flush bolts, lock strikes, locks, and hinges (see worksheets on pages C10-C11 or C13-C15 for details on how to order)

NOTE: Your door thickness is a nominal dimension. Doors can vary + or - 1/16" from the nominal dimension. When ordering, verify actual door thickness to assure a working fit of the door edge.

No. 304

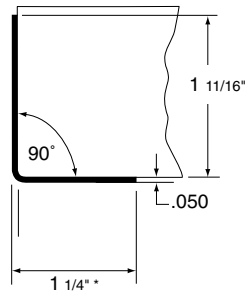

No. 305

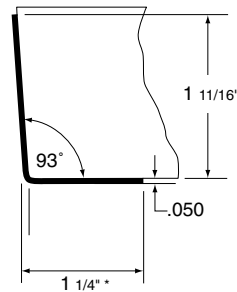

No. 306-RKW

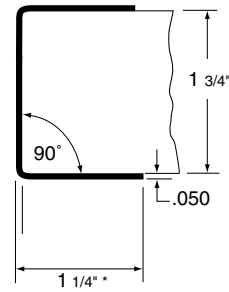

No. 306-AST
(with Astragal)

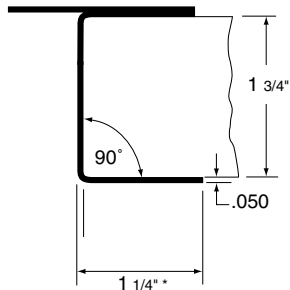

No. 306B

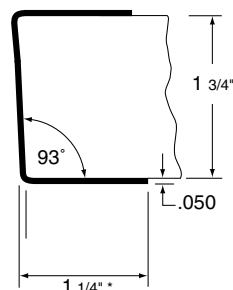

No. 306B-AST
(with Astragal)

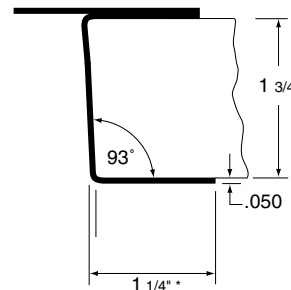

No. 307

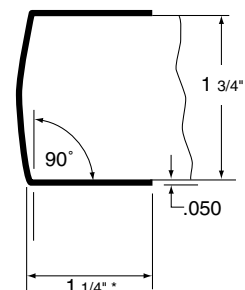

* Modified leg lengths available.

800 458 2424 | www.rockwoodmfg.com
Check the web site for the up-to-date catalog

Copyright © 2012-2024, ASSA ABLOY Accessories and Door Controls Group, Inc. All rights reserved. Reproduction in whole or in part without the express written permission of ASSA ABLOY Accessories and Door Controls Group, Inc. is prohibited.

ROCKWOOD®
ASSA ABLOY

Experience a safer
and more open world

Fill out this form and email/fax form to orders.rockwood@assaabloy.com / or fax to: 800-922-9212.

Customer Information

Company Name: _____ Date: _____

Account#: _____ Phone #/Fax #: _____

Email: _____ PO#: _____

Select a Door Edge

- Mortised: 300 301 302 302B
- Non-Mortised: 304 305 306-RKW 306-AST 306B 306B-AST
- 308 309 310 310B 310BS
- Other _____

Order Line #: _____ Quantity: _____ Handing: _____ Tag. Nos.: _____

Finish: _____

Select Hinge Size, Door Type and Fill in Dimensions

UL Rated

*Door Edge Height if different from net door height

Specify Mounting (if not standard)

- Torx Screws
 Tek Screws

*Standard Door Thickness is 1 3/4" if not please advise:

*Standard Leg Length for non mortised edge is 1 1/4" if not please advise:

*Standard Leg Length for mortised edge is 7/8" if not please advise:

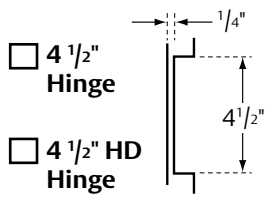
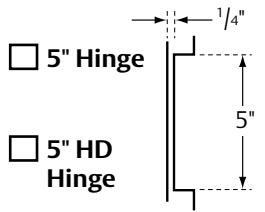

Door with 3 Hinges

Door with 4 Hinges

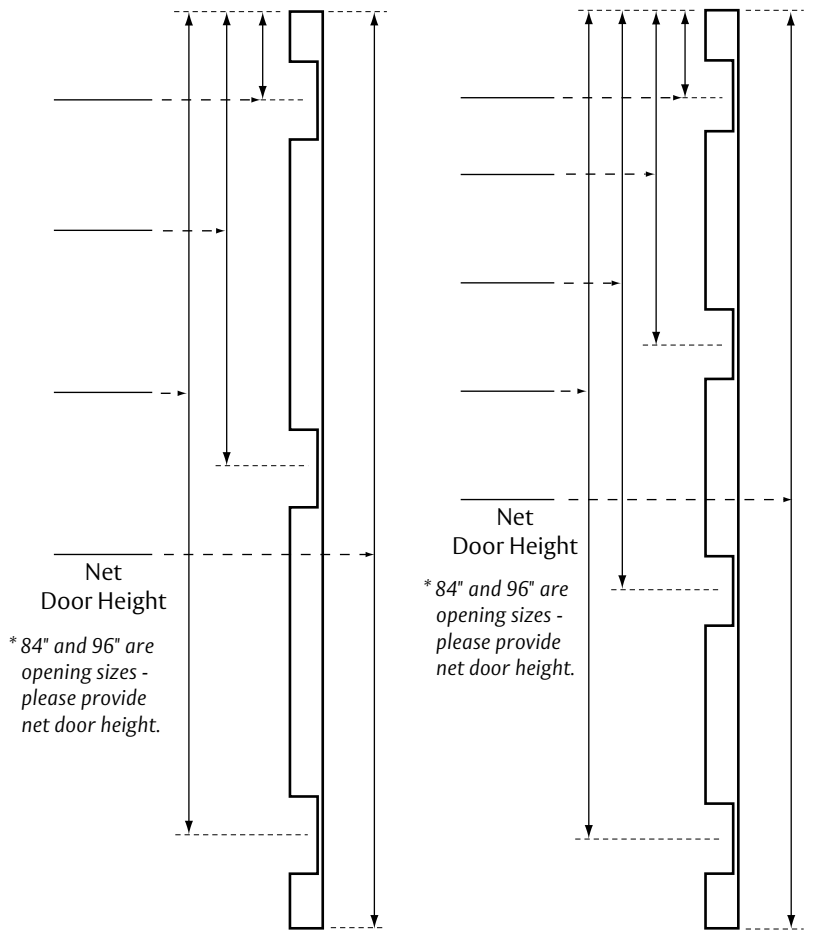

NOTE: Your door thickness is a nominal dimension. Doors can vary + or - 1/16" from the nominal dimension. When ordering, verify actual door thickness to assure a working fit of the door edge.

ROCKWOOD®

ASSA ABLOY

Experience a safer and more open world

800 458 2424 | www.rockwoodmfg.com
Check the web site for the up-to-date catalog

Copyright © 2012-2024, ASSA ABLOY Accessories and Door Controls Group, Inc. All rights reserved. Reproduction in whole or in part without the express written permission of ASSA ABLOY Accessories and Door Controls Group, Inc. is prohibited.

Fill out this form and email/fax form to orders.rockwood@assaabloy.com / or fax to: 800-922-9212.

Customer Information

Company Name: _____ Date: _____

Account#: _____ Phone #/Fax #: _____

Email: _____ PO#: _____

Select a Door Edge

- Mortised: 300 301 302 302B
- Non-Mortised: 304 305 306-RKW 306-AST 306B 306B-AST
- 308 309 310 310B 310BS
- Other _____

Order Line #: _____ Quantity: _____

Finish: _____ Handing: _____ Tag. Nos.: _____

Select Cutout, Door Type and Fill in Dimensions

UL Rated

*Door Edge Height if different from net door height

Astragal Side
(306-AST, 306B-AST ONLY)

- Active Door
 Inactive Door

Specify Mounting
(if not standard)

- Torx Screws
 Tek Screws

*Standard Door Thickness is 1 3/4" if not please advise:

*Standard Leg Length for non mortised edge is 1 1/4" if not please advise:

*Standard Leg Length for mortised edge is 7/8" if not please advise:

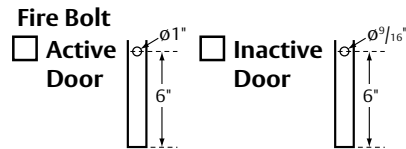
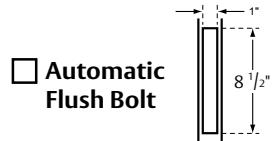

Metal Door

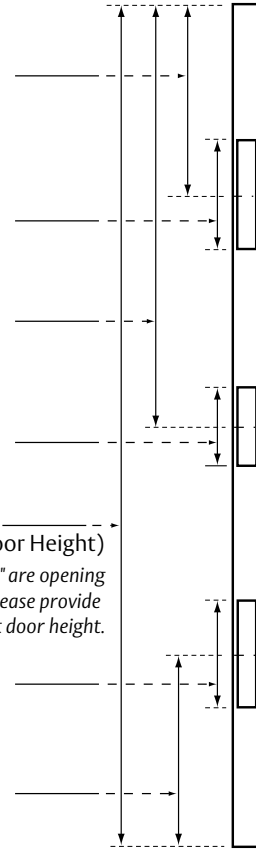

Wood Door

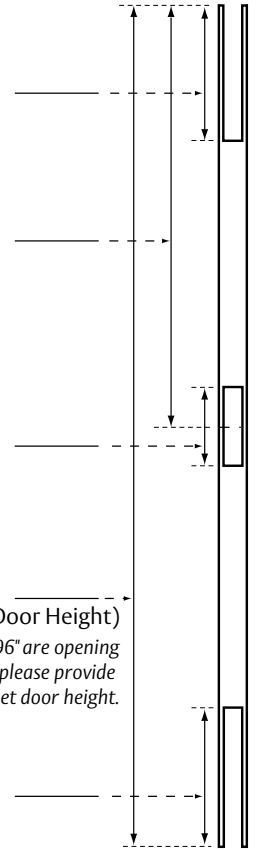

NOTE: Your door thickness is a nominal dimension. Doors can vary + or - 1/16" from the nominal dimension. When ordering, verify actual door thickness to assure a working fit of the door edge.

*Above is a representation of a prep location on the edge of the door.



Overlapping Door Edges No. 308, 309, 310, 310S, 310B, 310BS

Material: .050" brass, bronze, stainless steel

Finishes: Available in standard architectural finishes, US32DMS, US32D316, prime painted steel (see page 9)

Fastener: #6 x 5/8" FH SMS

Ordering: Specify any length (standard length is 42"). Specify wood or metal door



- Options:**
- UL fire rated listed for stainless steel, brass and bronze. For use on wood or plastic faced fire doors rated up to and including 1 1/2 hours or hollow metal, steel covered, composite type fire doors rated up to and including 3 hours. Specify UL when ordering (310-UL)
 - Cutouts for flush bolts, lock strikes, locks, and hinges (see worksheets on pages C10-C11 or C13-C15 for details on how to order)

NOTE: Your door thickness is a nominal dimension. Doors can vary + or - 1/16" from the nominal dimension. When ordering, verify actual door thickness to assure a working fit of the door edge.

No. 308

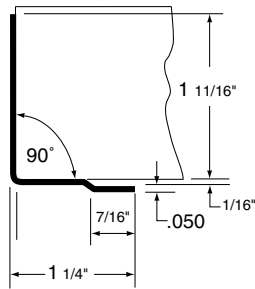

No. 309

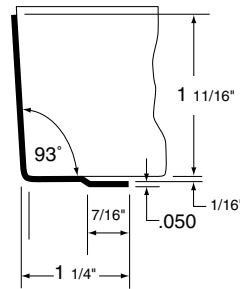

No. 310

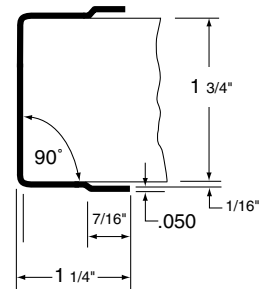

No. 310S
(single side)

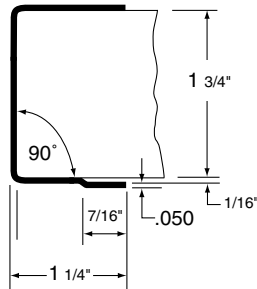

No. 310B

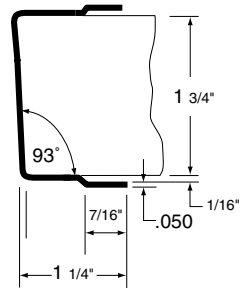

No. 310BS
(single side)

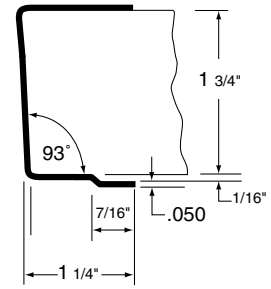

ROCKWOOD

ASSA ABLOY

Experience a safer
and more open world

800 458 2424 | www.rockwoodmfg.com
Check the web site for the up-to-date catalog

Copyright © 2012-2024, ASSA ABLOY Accessories and Door Controls Group, Inc. All rights reserved. Reproduction in whole or in part without the express written permission of ASSA ABLOY Accessories and Door Controls Group, Inc. is prohibited.

Ordering Instructions

The use of door edges and armor plates not only offers superior protection to expensive doors, it also adds an attractive and functional finishing touch. Armor plates and door edges are available in all architectural finishes. The following two pages are intended to help you determine the cutout locations required on armor plates and door edges. Follow the steps listed to assure complete consideration of all factors concerning cutout locations.

- Determine the armor plate height. We recommend 48" high. If you cut holes for lock, make the armor plate high enough to provide at least $\frac{1}{2}$ " from edge of the top cutout to the top edge of the plate, or $\frac{1}{2}$ " above the top of the lock front when mortise lock is used. This prevents a cutout running out of the top edge of the plate.
- Determine the armor plate width. Armor plates are usually mounted on the stop or push side of the door. Measure the net width of the door face and subtract the following depending on the type of door edges you specify:
 - non-mortise door edges = $2\frac{5}{8}$ " (for $\frac{1}{8}$ " gap)
 - overlapping door edges = 2" (for $\frac{3}{16}$ " overlap)
 - no door edges – single door = $1\frac{1}{4}$ "
 - no door edges – pairs of doors = 1" (without mullions)
- List all hardware that will be mounted on the door. Identify those items that will require armor plate and/or door edge cutouts; i.e., lock spindle, cylinder, thumb piece, lock front and strike, flush bolts, hinges, louvers, lites.
- Determine door undercut and location of armor plate and door edge to bottom of the door. We recommend mounting plates flush with the bottom of the door.
- Determine location of all hardware cutout centerlines from the bottom of the armor plate.

- Determine the backset of lock cutouts on the armor plate.

		Square Edge	Bevel Edge
a) with non-mortise door edges	lock backset minus	$1\frac{5}{16}$ "	$1\frac{3}{8}$ "
b) with overlapping door edges	lock backset minus	1"	$1\frac{1}{16}$ "
c) without door edges – single doors	lock backset minus	$\frac{5}{8}$ "	$1\frac{1}{16}$ "
d) without door edges – pair of doors (without mullions)	lock backset minus	$\frac{3}{8}$ "	$\frac{7}{16}$ "

- Specify the size of cutouts.

- Determine the hand of the door. Armor plates are typically mounted on the stop or push side of the door. Function holes must be given special attention as they may not be required on reverse bevel doors.

NOTE: Your door thickness is a nominal dimension. Doors can vary + or - $\frac{1}{16}$ " from the nominal dimension. When ordering, verify actual door thickness to assure a working fit of the door edge.

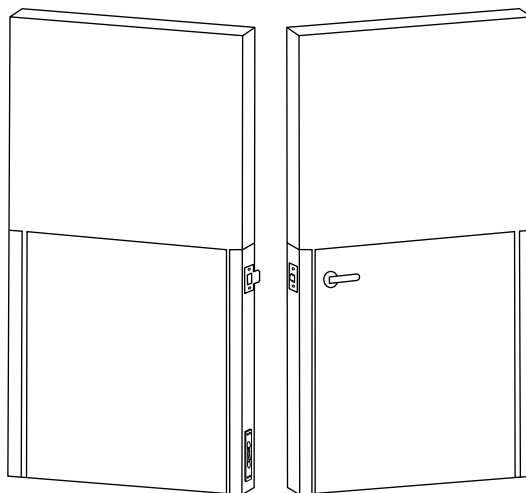

ROCKWOOD®
ASSA ABLOY

800 458 2424 | www.rockwoodmfg.com
Check the web site for the up-to-date catalog

Copyright © 2012-2024, ASSA ABLOY Accessories and Door Controls Group, Inc. All rights reserved. Reproduction in whole or in part without the express written permission of ASSA ABLOY Accessories and Door Controls Group, Inc. is prohibited.

Experience a safer
and more open world

Cutouts

This drawing shows typical location of cutouts on armor plates and door edges. It also illustrates non-mortise door edges, but this can be used as a guide for armor plates with overlapping door edges or no door edges. Use this as a worksheet to make your own drawings or photocopy and fill in your dimensions.

For Hinge Cutouts: Be sure to allow for door undercut and location of edge on door if other than flush with bottom.

For Lock Trim Protection: Consider using a trim protector bar (see pages C16-C20).

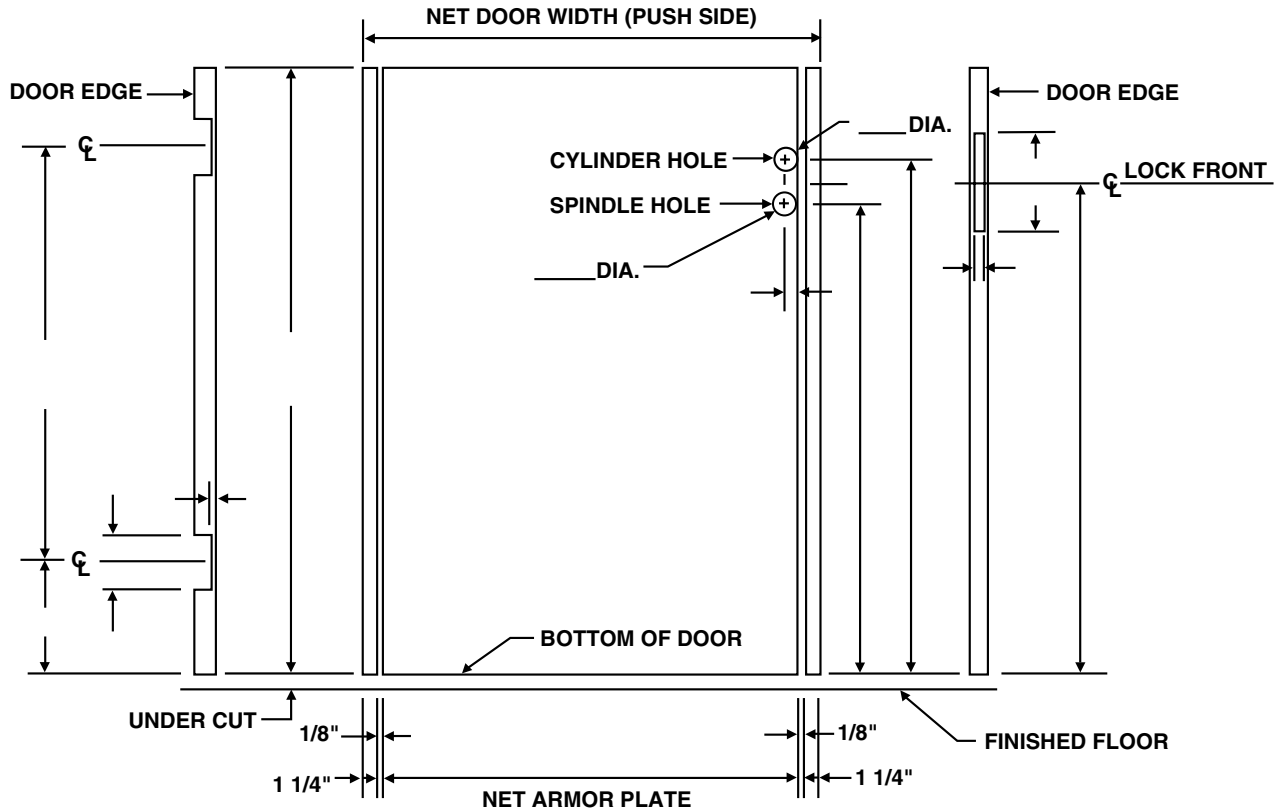

NOTE: Your door thickness is a nominal dimension. Doors can vary + or - 1/16" from the nominal dimension. When ordering, verify actual door thickness to assure a working fit of the door edge.

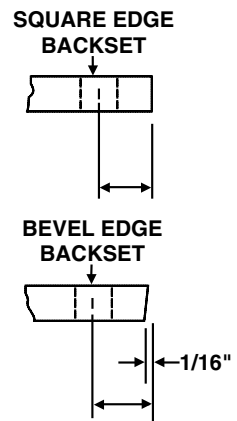

ROCKWOOD®

ASSA ABLOY

Experience a safer and more open world

800 458 2424 | www.rockwoodmfg.com
Check the web site for the up-to-date catalog

Copyright © 2012-2024, ASSA ABLOY Accessories and Door Controls Group, Inc. All rights reserved. Reproduction in whole or in part without the express written permission of ASSA ABLOY Accessories and Door Controls Group, Inc. is prohibited.

Cutouts

This drawing shows typical location of cutouts on armor plates and door edges. It also illustrates non-mortise door edges, but this can be used as a guide for armor plates with overlapping door edges or no door edges. Use this as a worksheet to make your own drawings or photocopy and fill in your dimensions.

For Hinge Cutouts: Be sure to allow for door undercut and location of edge on door if other than flush with bottom.

For Lock Trim Protection: Consider using a trim protector bar (see pages C16-C20).

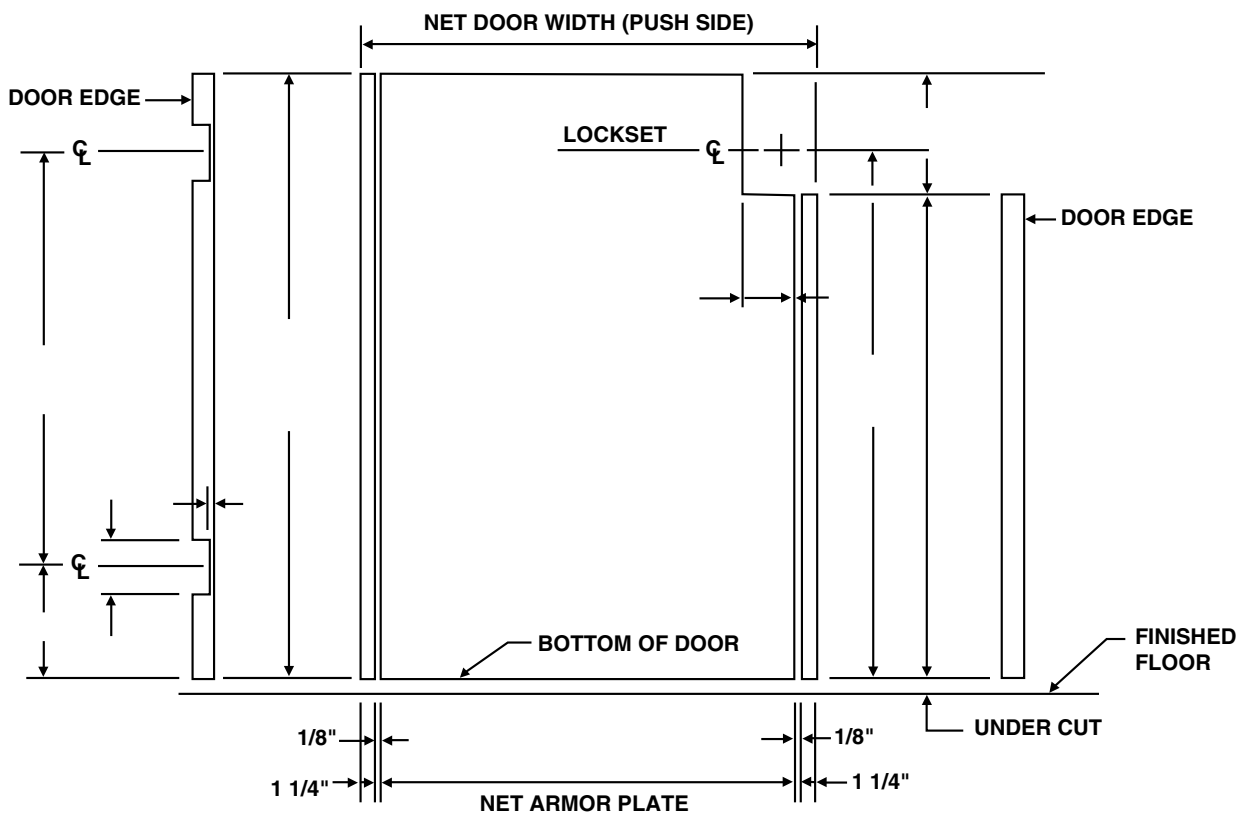

NOTE: Your door thickness is a nominal dimension. Doors can vary + or - 1/16" from the nominal dimension. When ordering, verify actual door thickness to assure a working fit of the door edge.

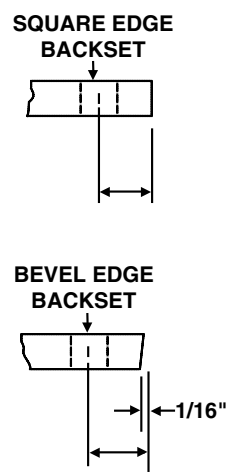

Solutions to Door and Trim Damage

Damage to doors and door trim (exit devices, knobs, levers, etc.) from hallway traffic such as carts and gurneys cost hospitals, schools and other institutions tens of thousands of dollars every year. The following four pages are Rockwood Product's line of Unique, Patented Protection Products designed to prevent this damage. Made from solid stainless steel the line is engineered to deflect traffic safely away from the door or trim.

Our line of trim protector bars is designed to safely deflect traffic away from exit devices, door knobs/levers, or other trim. These bars are made from solid stainless steel and are available in both standard duty ($\frac{3}{16}$ "") and heavy duty ($\frac{3}{8}$ "") versions. The bars are mounted either directly below, over, or in front of the trim depending on the application. They are available in a variety of projections and center to centers to fit your needs. If you require custom designs our engineering department can work with you to meet your needs.

Choosing the correct protection bar:

1. **Determine traffic** – light to moderate use = SD Series, heavy use = HD Series.
2. **Measure projection** – of exit device, door knob, etc.
3. **Review product dimension** – to match bar to your specific needs.



Warning: Do not locate protection bars where they can impede operation of exit devices.

How They Work

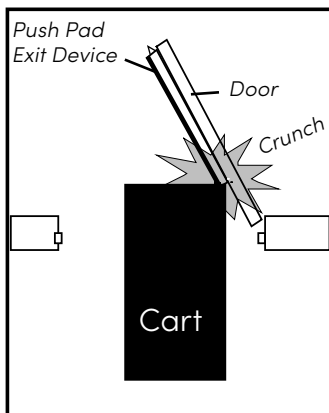

Without Bar – Costly Damage

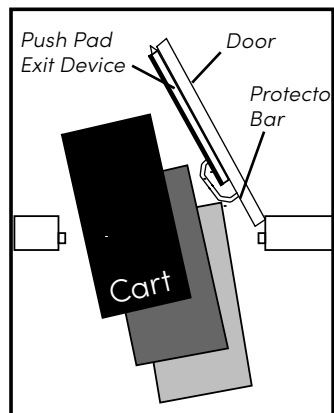

With Bar – Safely Deflected Away

ROCKWOOD®

ASSA ABLOY

Experience a safer
and more open world

800 458 2424 | www.rockwoodmfg.com
Check the web site for the up-to-date catalog

Copyright © 2012–2024, ASSA ABLOY Accessories and Door Controls Group, Inc. All rights reserved. Reproduction in whole or in part without the express written permission of ASSA ABLOY Accessories and Door Controls Group, Inc. is prohibited.

Heavy Duty Application

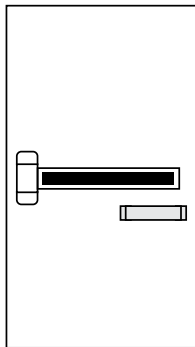

Application shown for product HD2230, HD2240, HD2250.
* Advise if door thickness is other than 1³/₄".



Heavy Duty Protector Bars HD2230, HD2230M

- Material:** Stainless steel
Finishes: US32D, US32DMS, 10BE
Fastener: 1/4 - 20 x 2 1/4" thru bolt & finish washer (standard 1 3/4" door*)
Other: Made to order sizes available

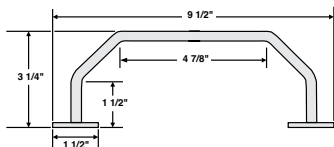

No.	CTC	Material Size	Projection	Weight
HD2230	8"	3/8" x 1 1/2"	3 1/4"	2.3 lbs.
HD2230M	Specify	3/8" x 1 1/2"	3 1/4"	—

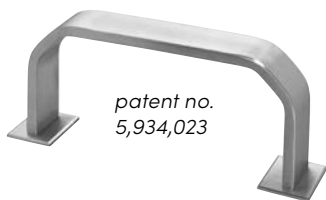

Heavy Duty Protector Bars HD2240, HD2240M

- Material:** Stainless steel
Finishes: US32D, US32DMS, 10BE
Fastener: 1/4 - 20 x 2 1/4" thru bolt & finish washer (standard 1 3/4" door*)
Other: Made to order sizes available

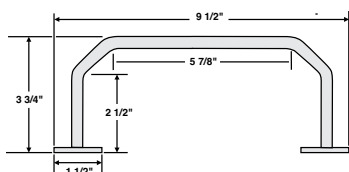

No.	CTC	Material Size	Projection	Weight
HD2240	8"	3/8" x 1 1/2"	3 3/4"	2.5 lbs.
HD2240M	Specify	3/8" x 1 1/2"	3 3/4"	—

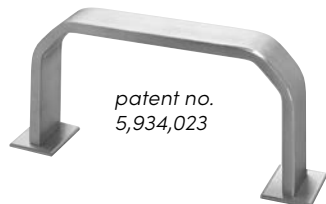

Heavy Duty Protector Bars HD2250, HD2250M

- Material:** Stainless steel
Finishes: US32D, US32DMS, 10BE
Fastener: 1/4 - 20 x 2 1/4" thru bolt & finish washer (standard 1 3/4" door*)
Other: Made to order sizes available

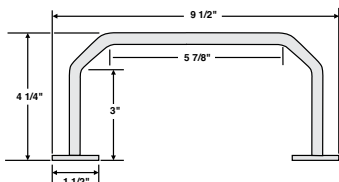

No.	CTC	Material Size	Projection	Weight
HD2250	8"	3/8" x 1 1/2"	4 1/4"	2.7 lbs.
HD2250M	Specify	3/8" x 1 1/2"	4 1/4"	—

Standard Duty Applications

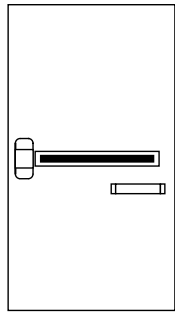

Application shown for product SD1230, SD1240, SD1250.

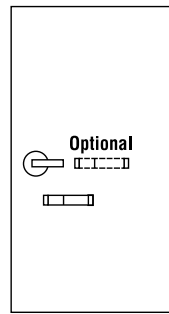

Application shown for product SD1260.



Standard Duty Protector Bar No. SD1230

- Material:** Stainless steel
- Finishes:** US32D, US32DMS, 10BE
- Fastener:** #10-24 x 1 FH MS and sex bolt

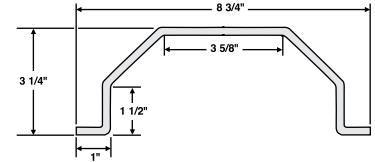

No.	CTC	Material Size	Projection	Weight
SD1230	8"	3/16" x 2"	3 1/4"	1.4 lbs.

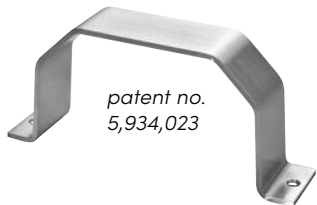

Standard Duty Protector Bar No. SD1240

- Material:** Stainless steel
- Finishes:** US32D, US32DMS, 10BE
- Fastener:** #10 - 24 x 1 FH MS and sex bolt

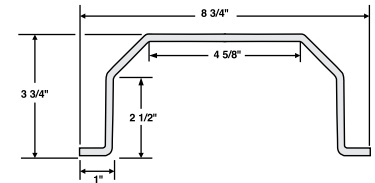

No.	CTC	Material Size	Projection	Weight
SD1240	8"	3/16" x 2"	3 3/4"	1.6 lbs.

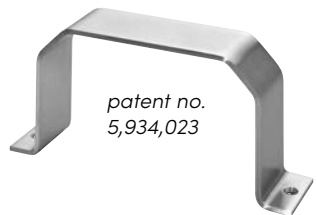

Standard Duty Protector Bar No. SD1250

- Material:** Stainless steel
- Finishes:** US32D, US32DMS, 10BE
- Fastener:** #10 - 24 x 1 FH MS and sex bolt

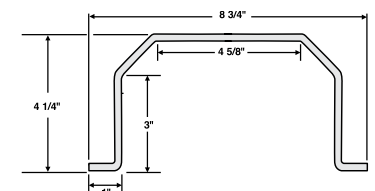

No.	CTC	Material Size	Projection	Weight
SD1250	8"	3/16" x 2"	4 1/4"	1.7 lbs.



Standard Duty Protector Bar No. SD1260

- Material:** Stainless steel
- Finishes:** US32D, US32DMS, 10BE
- Fastener:** #10 - 24 x 1 FH MS and sex bolt

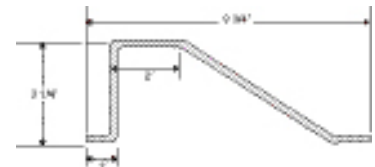

No.	CTC	Material Size	Projection	Weight
SD1260	8"	3/16" x 2"	3 1/4"	1.6 lbs.

ROCKWOOD

ASSA ABLOY

Experience a safer and more open world

800 458 2424 | www.rockwoodmfg.com
Check the web site for the up-to-date catalog

Copyright © 2012-2024, ASSA ABLOY Accessories and Door Controls Group, Inc. All rights reserved. Reproduction in whole or in part without the express written permission of ASSA ABLOY Accessories and Door Controls Group, Inc. is prohibited.

Applications

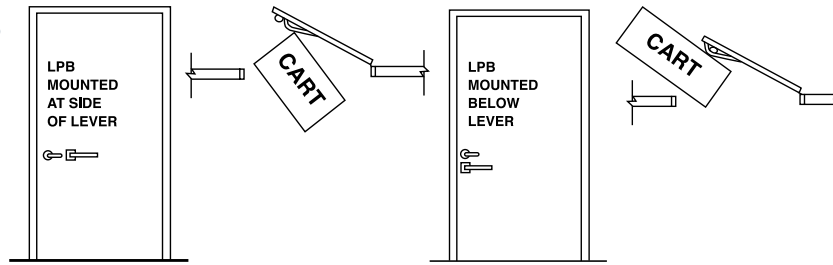

Application shown for product R101LPB thru R115LPB.

* Advise if door thickness is other than 1³/₄".



Trim Protector Bars No. R101LPB, R102LPB

Material: Stainless steel

Finishes: US32D, US32DMS, 10BE/BSP, BPC, FBPC, WPC, WSP, Stock Powder Coats

Fastener: 1/4 - 20 x 2 1/4" thru bolt, 1/4 - 20 x 2" thru bolt, finish washers (standard 1 3/4" door*)

Other: Made to order sizes available

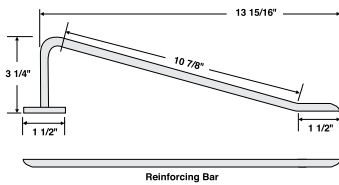

No.	CTC	Material Size	Weight
R101LPB	12"	3/8" x 1 1/2"	2.6 lbs.
R102LPB (with reinforcing bar)	12"	3/8" x 1 1/2"	4.6 lbs.



Trim Protector Bars – Lever Handle No. R111LPB, R112LPB

Material: Stainless steel

Finishes: US32D, US32DMS, 10BE/BSP, BPC, FBPC, WPC, WSP, Stock Powder Coats

Fastener: 1/4 - 20 x 2 1/4" thru bolt, 1/4 - 20 x 2" thru bolt, finish washers (standard 1 3/4" door*)

Other: Made to order sizes available

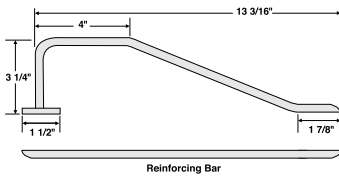

No.	CTC	Material Size	Weight
R111LPB	12"	3/8" x 1 1/2"	2.6 lbs.
R112LPB (with reinforcing bar)	12"	3/8" x 1 1/2"	4.6 lbs.



Trim Protector Bar - Long Lever Handle No. R115LPB

Material: Stainless steel

Finishes: US32D, US32DMS, 10BE/BSP

Fastener: 1/4 - 20 x 2 1/4" thru bolt, 1/4 - 20 x 2" thru bolt, finish washers (standard 1 3/4" door*)

Other: Made to order sizes available

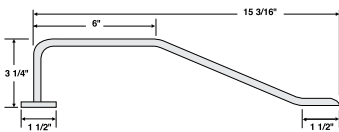

No.	CTC	Material Size	Weight
R115LPB	14"	3/8" x 1 1/2"	3.0 lbs.

EDP Application

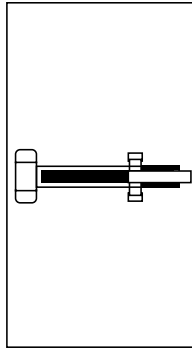

Application shown for product R116EDPL and R116EDPH.
Field cutting hinge end of exit device is required.

* Advise if door thickness is other than 1³/₄".

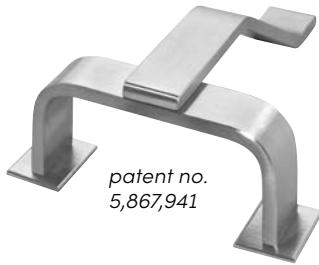

patent no.
5,867,941

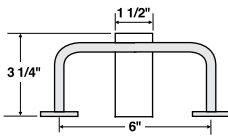
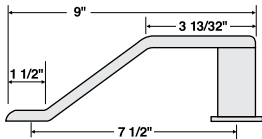

Exit Device Protector No. R116EDPL

Material: Stainless steel

Finishes: US32D, US32DMS, 10BE

Fastener: 2 ea. 1/4 - 20 x 2 1/4" thru bolts, 1 ea. 1/4 - 20 x 2" thru bolt, finish washers (standard 1 3/4" door*)

Features: Suitable for use with exit devices that project less than 2³/₈" from door face (i.e., SARGENT® 80 series, Monarch® 17 series, and Precision® Apex series)

No.	CTC	Material Size	Projection	Weight
R116EDPL	7 1/2"	3/8" x 1 1/2"	3 1/4"	3.5 lbs.

® SARGENT 80 series is a registered trademark of Sargent Manufacturing Company.

® Monarch 17 series is a registered trademark of Ingersoll-Rand Company.

® Precision Apex series is a registered trademark of Apex Machine Tool Company.

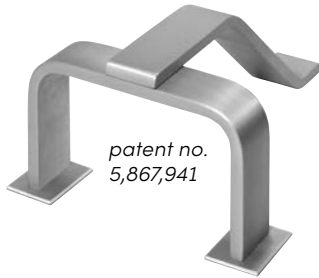

patent no.
5,867,941

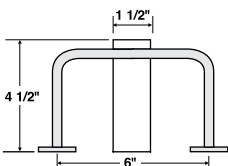
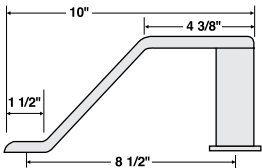

Exit Device Protector No. R116EDPH

Material: Stainless steel

Finishes: US32D, US32DMS, 10BE

Fastener: 2 ea. 1/4 - 20 x 2 1/4" thru bolts, 1 ea. 1/4 - 20 x 2" thru bolt, finish washers (standard 1 3/4" door*)

Features: Suitable for use with exit devices that project less than 3⁵/₈" from door face (i.e., Von Duprin® 33, 98 and 99 series, ASSA ABLOY ACCENTRA™ 7000 series, Corbin Russwin® ED500 series)

No.	CTC	Material Size	Projection	Weight
R116EDPH	8 1/2"	3/8" x 1 1/2"	4 1/2"	3.7 lbs.

® VonDuprin 33, 98, and 99 series is a registered trademark of Ingersoll-Rand Company.

® ASSA ABLOY ACCENTRA™ 7000 series is a registered trademark of ASSA ABLOY.

® Corbin Russwin ED500 series is a registered trademark of Corbin Russwin, Inc.

ROCKWOOD®

ASSA ABLOY

Experience a safer
and more open world

800 458 2424 | www.rockwoodmfg.com
Check the web site for the up-to-date catalog

Copyright © 2012-2024, ASSA ABLOY Accessories and Door Controls Group, Inc. All rights reserved. Reproduction in whole or in part without the express written permission of ASSA ABLOY Accessories and Door Controls Group, Inc. is prohibited.

Vertical Rod Cover

The vertical rod cover (BFRC) is a sturdy channel made of .050" stainless steel (other finishes available) designed to fit over the vertical rod, protecting it from damage caused by carts, gurneys, etc. It is available in 12" and 24" lengths.

Latch Guard Cover

The latch guard cover (BFLG) is made of .050" material and is designed with a 45° ramp, which when placed over the latch at the base of the door, deflects traffic safely away. It meets ADA requirements for a "smooth bottom door surface". The BFLG is available in 10", 12", and 16" lengths and most architectural finishes.

Application

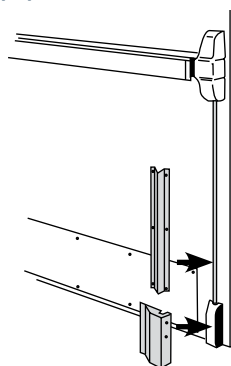

Application shown for products BFRC and BFLG. Protects vertical rod and latch of exit device. Meets ADA "smooth surface" requirements.



Vertical Rod Covers No. BFRC12, BFRC24

Material: .050" brass, bronze, stainless steel
Finishes: Available in standard architectural finishes (see page 9)
Fastener: #6x⁵/₈" OH SMS
Other: Made to order sizes available

No.	Height	Width	Projection	Weight
BFRC12	12"	3 ¹ / ₄ "	1 ⁵ / ₈ "	0.9 lbs.
BFRC24	24"	3 ¹ / ₄ "	1 ⁵ / ₈ "	1.8 lbs.

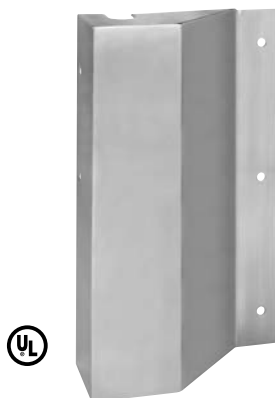

Latch Guard Covers No. BFLG10, BFLG12, BFLG16

Material: .050" stainless steel
Finishes: Available in standard architectural finishes (see page 9)
Fastener: #8 - 32 x ³/₄" OH MS; WS available on request
Ordering: Specify handing
Other: Made to order sizes available

No.	Height	Width	Projection	Weight
BFLG10	10"	6"	2 ³ / ₈ "	1.6 lbs.
BFLG12	12"	6"	2 ³ / ₈ "	1.9 lbs.
BFLG16	16"	6"	2 ³ / ₈ "	2.5 lbs.



Vertical Rod Latch Guard Cover No. BFLG1050

Material: .050" Stainless Steel
Finishes: US32D and Stock PC's
Height: 10"
Fastener: #10x⁵/₈" Self-Drilling Tek Screws
Ordering: Please specify handing and width of door (push side)

Certified to the below Standards:

- ICC-500 (2020)
- FEMA Guideline 320 (2014)
- FEMA Guideline 361 (2021)

Part of windstorm assembly cards: ZHLA.47 and ZHLA.51

No.	Height	Width	Projection
BFLG1050	10"	Specify	2 ³ / ₈ "

ROCKWOOD®

ASSA ABLOY

Experience a safer
and more open world

Rockwood custom strikes are manufactured to your specifications in almost any size, shape and finish. The drawings below represent standard ASA and T strikes. For easy and efficient ordering, please use the order form on the next page and fill in your requirements on drawing(s) and chart then fax or email us the form.

NOTE: Any dimensions are possible. Contact us with your requirements.

Material: .090" brass, bronze, stainless steel

Finishes: US3, US4, US10, US10B, US32D, US32

Fastener: CS-ASA: #12 WS or #12 - 24 MS.
 CS-OM: #12 WS or #12 - 24 MS.
 CS-T: #8 WS or #8 - 24 MS
 590DA: #8 WS or #8 - 24 MS

Bolt Hole: Common sizes are: $1\frac{1}{16}$ " x $1\frac{1}{4}$ " and $\frac{3}{4}$ " x $1\frac{1}{4}$ "; any size available

Options:

- .050", .062", or .125" thickness
- TORX - security Torx screws
- Finish on both sides
- Custom filler plates available
- Full lip

CS-ASA1

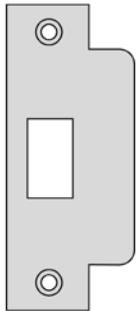

CS-ASA2

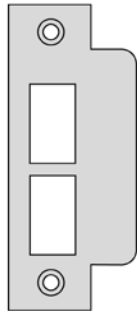

CS-OM

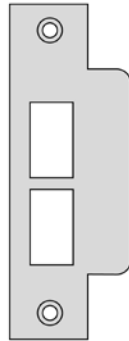

CS-T



590DA

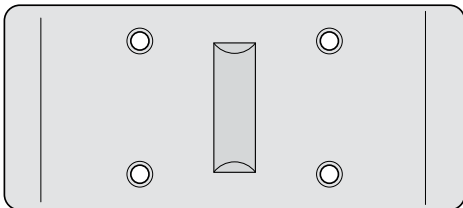

ROCKWOOD®

ASSA ABLOY

Experience a safer
and more open world

800 458 2424 | www.rockwoodmfg.com
 Check the web site for the up-to-date catalog

Copyright © 2012-2024, ASSA ABLOY Accessories and Door Controls Group, Inc. All rights reserved. Reproduction in whole or in part without the express written permission of ASSA ABLOY Accessories and Door Controls Group, Inc. is prohibited.

Customer Information

Contact Name: _____

Date: _____

Company Name: _____

Account #: _____

Address: _____

Phone #/Fax #: _____

City/State/Zip: _____

Email: _____

CS-ASA1

#12 Screw
Specify
Wood
or Metal _____

Lip to Centerline _____

Select Bolt Hole Size
 1 1/16" x 1 1/4" 3/4" x 1 1/4" Other: W _____ x L _____

CS-ASA2

#12 Screw
Specify
Wood
or Metal _____

Lip to Centerline _____

Select Bolt Hole Size
 1. 1 1/16" x 1 1/4" 3/4" x 1 1/4" Other: W _____ x L _____
 2. 1 1/16" x 1 1/4" 3/4" x 1 1/4" Other: W _____ x L _____

CS-T

#8 Combo
Screw _____

Lip to Centerline _____

Select Bolt Hole Size
 1 1/16" x 1 1/4" 3/4" x 1 1/4" Other: W _____ x L _____

CS-OM

#12 Screw
Specify
Wood
or Metal _____

Lip to Centerline _____

Select Bolt Hole Size
 1. 1 1/16" x 1 1/4" 3/4" x 1 1/4" Other: W _____ x L _____
 2. 1 1/16" x 1 1/4" 3/4" x 1 1/4" Other: W _____ x L _____

Order Form for CS-ASA1, CS-ASA2, CS-OM, CS-T

Order Line #	Qty	Part #	Flat or Curved	LH	RH	MS or WS Fastener	Finish
Options							

590-DA

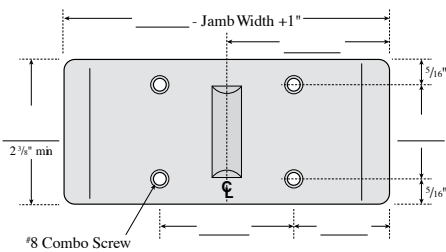
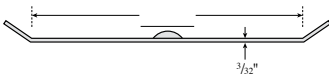

Order Form for 590-DA

Is Door: Center Hung¹ Flush with Jamb²

Order Line #	Quantity	Part #	Jamb Width	Finish
Options				

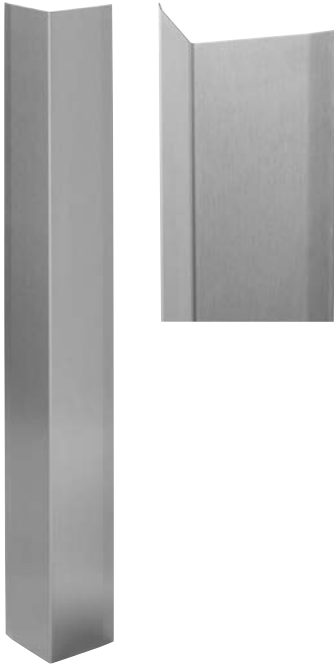

Corner Guards No. 290, 291

- Material:** .050" brass, bronze, stainless steel
- Finishes:** Available in standard architectural finishes (see page 9)
- Mounting:** Self-adhesive mounting
- Ordering:** Specify size
- Other:** Other lengths available up to 96", leg widths up to 6"

No.	Standard Sizes	Top Corners	Weight
290	2" x 2" x 40"	Square	2.4 lbs.
	2" x 2" x 48"		2.8 lbs.
	3" x 3" x 40"		3.5 lbs.
	3" x 3" x 48"		4.2 lbs.
291	2" x 2" x 40"	Rounded	2.4 lbs.
	2" x 2" x 48"		2.8 lbs.
	3" x 3" x 40"		3.5 lbs.
	3" x 3" x 48"		4.2 lbs.

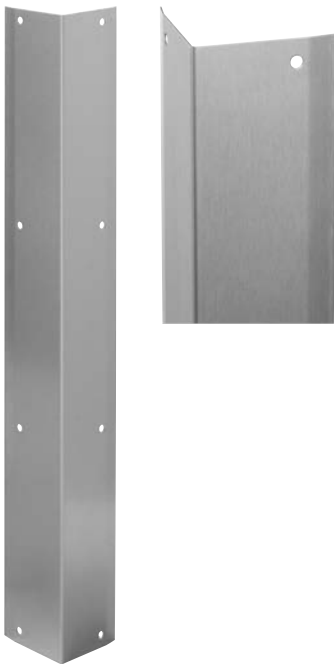

Corner Guards No. 295, 296

- Material:** .050" brass, bronze, stainless steel
- Finishes:** Available in standard architectural finishes (see page 9)
- Fastener:** #6 x 5/8" OH SMS
- Ordering:** Specify size
- Other:** Other lengths available up to 96", leg widths up to 6"

No.	Standard Sizes	Top Corners	Weight
295	2" x 2" x 40"	Square	2.4 lbs.
	2" x 2" x 48"		2.8 lbs.
	3" x 3" x 40"		3.5 lbs.
	3" x 3" x 48"		4.2 lbs.
296	2" x 2" x 40"	Rounded	2.4 lbs.
	2" x 2" x 48"		2.8 lbs.
	3" x 3" x 40"		3.5 lbs.
	3" x 3" x 48"		4.2 lbs.

ROCKWOOD®

ASSA ABLOY

Experience a safer
and more open world

800 458 2424 | www.rockwoodmfg.com
Check the web site for the up-to-date catalog

Copyright © 2012-2024, ASSA ABLOY Accessories and Door Controls Group, Inc. All rights reserved. Reproduction in whole or in part without the express written permission of ASSA ABLOY Accessories and Door Controls Group, Inc. is prohibited.



Latch Protector No. 320-RKW

- Material:** .105" steel, stainless steel
- Finishes:** US2C (cadmium plated), US32D, and 10BE
- Fastener:** $\frac{5}{16}$ " - 18 carriage bolts and hex drive sex nuts
- Ordering:** Specify product number and finish
- Features:** Jamb pin prevents prying of door. Non-handed

No.	Material Size	Lock Type	Weight
320-RKW	3" x 11"	Cylindrical or mortise	1.2 lbs.

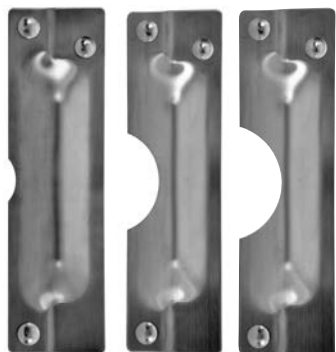

320C 320CL 320CXL

Latch Protectors No. 320C, 320CL, 320CXL

- Material:** .090" steel, stainless steel
- Finishes:** US2C (cadmium plated), US32D, and 10BE
- Fastener:** $\frac{5}{16}$ " - 18 carriage bolts and hex drive sex nuts
- Ordering:** Specify product number and finish
- Features:** Jamb pin prevents prying of door. Non-handed
- No. 320C: Notched for $2\frac{1}{8}$ " or less diameter rose on cylindrical lockset
- No. 320CL: Notched for $2\frac{1}{4}$ " - $3\frac{1}{4}$ " diameter rose on cylindrical lockset
- No. 320CXL: Notched for $2\frac{1}{4}$ " - $3\frac{3}{4}$ " diameter rose on cylindrical lockset

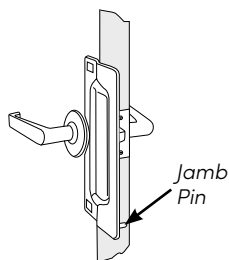

No.	Material Size	Lock Type	Weight
320C	3" x 11"	Cylindrical	1.2 lbs.
320CL	3" x 11"	Cylindrical	1.2 lbs.
320CXL	3" x 11"	Cylindrical	1.2 lbs.



Latch Protector No. 321

- Material:** .105" steel, stainless steel
- Finishes:** US2C (cadmium plated), US32D, and 10BE
- Fastener:** $\frac{5}{16}$ " - 18 carriage bolts and hex drive sex nuts
- Ordering:** Specify product number and finish

No.	Material Size	Lock Type	Weight
321	$1\frac{1}{2}$ " x 10"	Mortise	0.7 lbs.



Latch Protector No. 322

- Material:** .100" steel, stainless steel
- Finishes:** US2C (cadmium plated), US32D, and 10BE
- Fastener:** $\frac{5}{16}$ " - 18 carriage bolts and hex drive sex nuts
- Ordering:** Specify product number and finish
- Features:** Compact size. Non-handed

No.	Material Size	Lock Type	Weight
322	1 $\frac{5}{8}$ " x 6"	Cylindrical	5.6 oz.



Cast Latch Protector No. 325

- Material:** .375" solid cast brass
- Finishes:** US26D
- Fastener:** $\frac{1}{4}$ " - 20 thru bolts & finish washer
- Ordering:** Specify product number and finish
- Features:** Clean aesthetic design with no exposed fasteners

No.	Material Size	Lock Type	Weight
325	1 $\frac{7}{8}$ " x 9 $\frac{1}{2}$ "	Mortise or cylindrical	1.1 lbs.

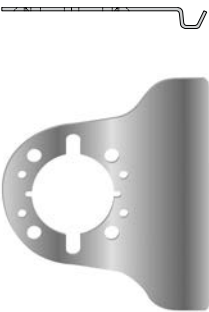

Anti-Vandal Latch Protector No. 330

- Material:** .090" stainless steel
- Finishes:** US32D
- Fastener:** #8 x $\frac{3}{4}$ " FH stainless steel combo screws
- Ordering:** Specify product number and finish
- Features:**
- Protects cylindrical locks from forced entry and vandalism
 - Fast and simple installation
 - Non-handed
 - Attractive appearance

No.	Material Size	Lock Type	Weight
330	5 $\frac{3}{8}$ " x 6"	Cylindrical	1.8 lbs.

ROCKWOOD®

ASSA ABLOY

Experience a safer
and more open world

800 458 2424 | www.rockwoodmfg.com
Check the web site for the up-to-date catalog

Copyright © 2012-2024, ASSA ABLOY Accessories and Door Controls Group, Inc. All rights reserved. Reproduction in whole or in part without the express written permission of ASSA ABLOY Accessories and Door Controls Group, Inc. is prohibited.



Solid Cast Wall Stops No. 400, 401, 402

Material: Cast brass with rubber bumper

Finishes: Available in standard architectural finishes (see page 9)

Features: Concealed mounting, convex bumper.

No.	Bumper	Fastener	Size	Projection	Weight
400	Convex	#6 x 1 1/2" FH SMS, plastic toggle	2 7/16" dia.	1"	2 lbs./10
401	Convex	#8 x 1" RH WS, plastic anchor	2 7/16" dia.	1"	2 lbs./10
402	Convex	#8 - 32 x 1" TH MS, anchor	2 7/16" dia.	1"	2 lbs./10



Solid Cast Wall Stops No. 403, 404, 405

Material: Cast brass with rubber bumper

Finishes: Available in standard architectural finishes (see page 9)

Features: Concealed mounting, concave bumper.

No.	Bumper	Fastener	Size	Projection	Weight
403	Concave	#6 - 1 1/2" FH SMS, plastic toggle	2 7/16" dia.	1"	2 lbs./10
404	Concave	#8 x 1" RH WS, plastic anchor	2 7/16" dia.	1"	2 lbs./10
405	Concave	#8 - 32 x 1" TH MS, anchor	2 7/16" dia.	1"	2 lbs./10



Wrought Wall Stops No. 406

Material: Wrought brass, bronze, and stainless steel with rubber bumper

Finishes: Available in standard architectural finishes (see page 9)

Features:

- Concealed mounting, convex bumper. Back plate prevents damage to wall
- Accepted by the New York State Office of Mental Health (OMH) for use in high risk areas

No.	Bumper	Fastener	Size	Projection	Weight
406	Convex	#8 x 1 1/4" TH SMS, plastic toggle	2 1/2" dia.	1"	1 1/4 lbs./10



Wrought Wall Stops No. 409

Material: Wrought brass, bronze, and stainless steel with rubber bumper

Finishes: Available in standard architectural finishes (see page 9)

Features:

- Concealed mounting, concave bumper. Back plate prevents damage to wall
- Accepted by the New York State Office of Mental Health (OMH) for use in high risk area

No.	Bumper	Fastener	Size	Projection	Weight
409	Concave	#8 x 1 1/4" TH SMS, plastic toggle	2 1/2" dia.	1"	1 1/4 lbs./10



Solid Cast Wall Stop No. 412

- Material:** Cast brass with rubber bumper
- Finishes:** Available in standard architectural finishes (see page 9)
- Features:** For where concealed mounting is not desired. School version
- Options:** Tamperproof Torx screws

No.	Bumper	Fastener	Size	Projection	Weight
412	Convex	#8 x 1 ³ / ₄ " FH SMS	2 ⁷ / ₁₆ " dia.	1"	3.5 lbs./10



Solid Cast Wall Stop No. 415

- Material:** Cast brass with rubber bumper
- Finishes:** Available in standard architectural finishes (see page 9)
- Features:** Large size with flush back plate spreads impact of heavy or uncontrolled door contact – avoiding damage to wall. Universal screw pack is included for all wall conditions

No.	Bumper	Fastener	Size	Projection	Weight
415	Convex	1 - #8 - 32x2" RH MS and toggle bolt	4" dia.	3/4"	10 oz. each
		1 - #12 - 24 x 1 ¹ / ₄ " RH MS and anchor			
		3 - #8 x 1 ¹ / ₄ " FH SMS and plastic anchors			
		3 - #8 - 32x ¹ / ₄ " FH MS			



Solid Cast Wall Stop No. 416

- Material:** Cast brass with rubber bumper
- Finishes:** Available in standard architectural finishes (see page 9)
- Features:** For use where concealed mounting is not desired. School version
- Options:** Tamperproof Torx screws

No.	Bumper	Fastener	Size	Projection	Weight
416	Concave	#8 x 1 ³ / ₄ " FH SMS	2 ⁷ / ₁₆ " dia.	1"	3.5 lbs./10

ROCKWOOD[®]

ASSA ABLOY

Experience a safer
and more open world

800 458 2424 | www.rockwoodmfg.com
Check the web site for the up-to-date catalog

Copyright © 2012-2024, ASSA ABLOY Accessories and Door Controls Group, Inc. All rights reserved. Reproduction in whole or in part without the express written permission of ASSA ABLOY Accessories and Door Controls Group, Inc. is prohibited.



Wrought Wall Stop No. 426

Material: Wrought brass and stainless steel with rubber bumper

Finishes: US32D, 10BE, Stock Powder Coats

Other: Concealed mounting

No.	Bumper	Fastener	Size	Projection	Weight
426	Concave	#8 x 1 1/4" TH SMS, plastic toggle and plastic anchor	1 7/8" dia.	1"	1 lbs./10



Solid Cast Wall Stop No. 430-RKW

Material: Solid brass with rubber bumper

Finishes: Available in standard architectural finishes (see page 9)

Features:

- Compact design for use on hotel bathroom doors swinging into the tub area, or where an inconspicuous bumper is desired.
- Concealed mounting

No.	Bumper	Fastener	Size	Projection	Weight
430-RKW	Convex	#6 x 3/4" OH SMS, plastic anchor	1" dia	7/16"	0.5 lbs./10



Wall Stop No. 431-RKW

Material: Gray rubber bumper

Finishes: Gray

Features: Economical bumper for applications where a completely concealed mounting is not required

No.	Bumper	Fastener	Size	Projection	Weight
431-RKW	Concave	#8 x 1 1/4" TH SMS, #8 flat washer, plastic toggle	1 9/16" dia.	15/16"	1.0 lbs./10



Wall Stop No. 432W

Material: White rubber bumper

Finishes: White

Features:

- Economical
- Self-adhesive mounting

No.	Bumper	Fastener	Size	Projection	Weight
432W	Concave	Self-adhesive tape	1 9/16" dia.	3/4"	5 oz./10



Low Dome Stops No. 440, 441

- Material:** Solid cast brass with rubber bumper
- Finishes:** Available in standard architectural finishes (see page 9)
- Other:** No. 441 is packed with both WS and MS fasteners
- Features:** For doors without thresholds (not undercut).
- Options:** Exterior pack screw packs, stainless steel plated to match — use EXP suffix (440 x EXP) when ordering.

No.	Fastener	Base	Height	Weight
440	#12x1 ¹ / ₄ " FH WS, plastic anchor	1 ¹ / ₄ " h x 1 ⁷ / ₈ " dia.	1 ¹ / ₈ "	1.5 lbs./10
441	#12x1 ¹ / ₂ " FH WS, plastic anchor; #12 - 24 x 1 ¹ / ₂ " FH MS, anchor	1 ¹ / ₄ " h x 1 ⁷ / ₈ " dia.	1 ¹ / ₈ "	2.1 lbs./10



Dome Stop Combination Unit No. 441CU

- Material:** Solid cast brass with rubber bumper
- Finishes:** Available in standard architectural finishes (see page 9)
- Other:** Set consists of 1 each No. 441 and 1 each No. 444. For use at doors with or without a threshold
- Features:** Convertible for undercut or not undercut doors
- Options:** Exterior pack screw packs, stainless steel plated to match — use EXP suffix (441CU x EXP) when ordering

No.	Fastener	Base	Height	Weight
441CU	#12x1 ¹ / ₂ " FH WS, plastic anchor; #12 - 24x1 ¹ / ₂ " FH MS, anchor	Dome stop: 1 ¹ / ₄ " h x 1 ⁷ / ₈ " dia. Riser: 3 ³ / ₈ " h x 2" dia.	1 ¹ / ₈ " or 1 ¹ / ₂ "	1.85 lbs./10
444	Cast riser only	3 ³ / ₈ " h x 1 ³ / ₄ " dia.	3 ³ / ₈ "	10 oz. /10

ROCKWOOD®

ASSA ABLOY

Experience a safer
and more open world

800 458 2424 | www.rockwoodmfg.com
Check the web site for the up-to-date catalog

Copyright © 2012-2024, ASSA ABLOY Accessories and Door Controls Group, Inc. All rights reserved. Reproduction in whole or in part without the express written permission of ASSA ABLOY Accessories and Door Controls Group, Inc. is prohibited.



Cast Universal Dome Stop No. 441H

- Material:** Solid cast brass with rubber bumper
- Finishes:** Available in standard architectural finishes (see page 9)
- Features:** Low lip dome stop with height of high dome stop, eliminates the need to determine requirement for traditional low or high dome stop – one stop for all applications. Integral cast pin for added strength. Universal screw pack included for all floor conditions
- Options:** Exterior pack screw packs, stainless steel plated to match – use EXP suffix (441H x EXP) when ordering.

No.	Fastener	Base	Height	Weight
441H	#12 x 1 $\frac{1}{4}$ " FH WS, plastic anchor #12 - 24 x 1" FH MS, anchor	$\frac{7}{32}$ " h x 1 $\frac{7}{8}$ " dia.	1 $\frac{11}{16}$ "	3.2 lbs./10



High Dome Stops No. 442, 443

- Material:** Solid cast brass with rubber bumper
- Finishes:** Available in standard architectural finishes (see page 9)
- Other:** No. 443 is packed with both WS and MS fasteners
- Features:** For doors with thresholds or undercut doors
- Options:** Exterior pack screw packs, stainless steel plated to match – use EXP suffix (442 x EXP) when ordering.

No.	Fastener	Base	Height	Weight
442	#12 x 1 $\frac{1}{2}$ " FH WS, plastic anchor	$\frac{1}{2}$ " h x 1 $\frac{7}{8}$ " dia.	1 $\frac{1}{2}$ "	2.8 lbs./10
443	#12 x 1 $\frac{1}{2}$ " FH WS, plastic anchor; #12 - 24 x 1" FH MS, anchor	$\frac{1}{2}$ " h x 1 $\frac{7}{8}$ " dia.	1 $\frac{5}{16}$ "	3.2 lbs./10



No. 445



No. 445H

Heavy Duty Door Stop No. 445, 445H

- Material:** Solid cast brass with rubber bumper
- Finishes:** Available in standard architectural finishes (see page 9)
- Features:** Extra heavy duty dome type stop for heavy and high frequency doors
- Options:** Exterior pack screw packs, stainless steel plated to match – use EXP suffix (445 x EXP) when ordering.

No.	Fastener	Base	Height	Weight
445	2 ea. #12 x 1 $\frac{1}{2}$ " FH SMS, plastic anchor; #12 - 24 x 1" FH MS, anchor	2" x 4"	1 $\frac{1}{8}$ "	4.6 lbs./10
445H	2 ea. #12 x 1 $\frac{1}{2}$ " FH SMS, plastic anchor; #12 - 24 x 1" FH MS, anchor	2" x 4"	1 $\frac{11}{16}$ "	6 lbs./10

ROCKWOOD®

ASSA ABLOY

Experience a safer
and more open world



Door Stop Riser No. 449

- Material:** Aluminum
- Finishes:** Mill aluminum or painted to match
- Ordering:** Specify finish and thickness; $\frac{1}{4}$ " $\frac{3}{8}$ " $\frac{1}{2}$ " $\frac{5}{8}$ " $\frac{3}{4}$ " 1"
- Other:** Full size carpet riser provides sturdy base for mounting the No. 440 or No. 442 dome stop

No.	Fastener	Base	Height	Weight
449	#12 WS, plastic anchor	$1\frac{7}{8}$ " dia.	As specified	1.6 lbs./10



Door Stop No. 446

- Material:** Brass with rubber bumper.
- Finishes:** Available in standard architectural finishes (see page 9).
- Features:** Modern style universal stop.
- Options:** Rubber bumper available in standard gray or optional black.

No.	Fastener	Base	Height	Weight
446	#12x1 $\frac{1}{2}$ " WS, plastic anchor; #12-24x1" FH MS, anchor	$\frac{1}{4}$ "	1 $\frac{1}{2}$ "	0.5 lbs.

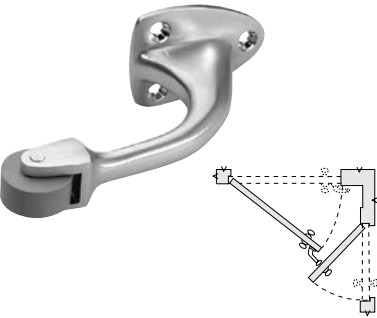

Curved Roller Stop No. 455

- Material:** Solid cast brass with rubber bumper
- Finishes:** Available in standard architectural finishes (see page 9)
- Features:** For use where doors swing into each other at odd angles

No.	Fastener	Base	Projection	Weight
455	3 ea. #8x $\frac{3}{4}$ " OH SMS	$1\frac{5}{8}$ " x $2\frac{1}{4}$ "	$2\frac{3}{4}$ "	5 lbs./10

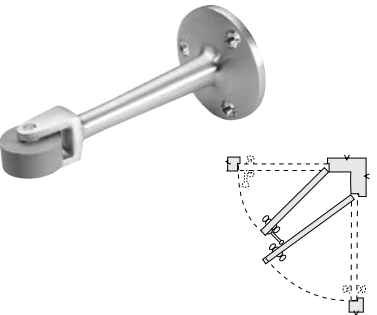

Straight Roller Stop No. 456-RKW

- Material:** Solid cast brass with rubber bumper
- Finishes:** Available in standard architectural finishes (see page 9)
- Features:** For use where doors swing into each other at right angles

No.	Fastener	Base	Projection	Weight
456-RKW	3 ea. #8x $\frac{3}{4}$ " OH SMS	2" dia.	$4\frac{9}{16}$ "	4.1 lbs./10

ROCKWOOD[®]

ASSA ABLOY

Experience a safer
and more open world

800 458 2424 | www.rockwoodmfg.com
Check the web site for the up-to-date catalog

Copyright © 2012-2024, ASSA ABLOY Accessories and Door Controls Group, Inc. All rights reserved. Reproduction in whole or in part without the express written permission of ASSA ABLOY Accessories and Door Controls Group, Inc. is prohibited.



Straight Roller Stop No. 456L

Material: Solid cast brass with rubber bumper

Finishes: Available in standard architectural finishes (see page 9)

Features: For use where doors swing into each other at right angles

No.	Fastener	Base	Projection	Weight
456L	3 ea. #8x ³ / ₄ " OH SMS	2" dia.	6 ¹ / ₄ "	4.8 lbs./10



Kick Down Door Stop No. 458

Material: Cast zinc with rubber bumper

Finishes: Available in bright brass (BRS), dull bronze (BRZ), and bright chrome plate (CRM)

Features:

- Uses replacement bumper No. 461B
- Rubber bumper provides reliable grip on floor.

No.	Fastener	Base	Projection	Weight
458	3 ea. #8x1" OH SMS	1 ⁵ / ₈ "x1 ⁷ / ₈ "	4"	3.3 lbs./10



Spring Loaded Plunger Stop No. 459

Material: Solid cast brass with rubber bumper

Finishes: Available in standard architectural finishes (see page 9)

Features:

- Uses replacement bumper No. 461B
- Foot operated, spring loaded
- Rubber bumper provides reliable grip on floor

No.	Fastener	Base	Projection	Weight
459	3 ea. #8x ³ / ₄ " OH SMS	1 ³ / ₈ "x5 ³ / ₈ "	1 ⁷ / ₈ "	4.7 lbs./10



Kick Down Door Stop No. 460

Material: Solid cast aluminum with rubber bumper

Finishes: Spray painted silver (ALM), brass (BRS), bronze (BRZ) or brown to match US10B (ORB)

Features:

- Uses replacement bumper No. 461B
- Rubber bumper provides reliable grip on floor.

No.	Fastener	Base	Projection	Weight
460	4 ea. #8x1" FH SMS	2 ¹ / ₁₆ "x1 ³ / ₈ "	4"	2.7 lbs./10



Kick Down Door Stop No. 461

Material: Solid cast brass with rubber bumper

Finishes: Available in standard architectural finishes (see page 9)
Rubber bumper available in gray or black

Features:

- Uses replacement bumper No. 461B
- Rubber bumper provides reliable grip on floor
- A unique assembly design that conceals the axle in the base

No.	Fastener	Base	Projection	Weight
461	4 ea. #8 x 3/4" OH SMS	2 1/4" x 1 1/4"	3 5/8"	5.1 lbs./10



Kick Down Door Stop No. 461L

Material: Solid cast brass with rubber bumper

Finishes: Available in standard architectural finishes (see page 9).
Rubber bumper available in gray or black

Features:

- Uses replacement bumper No. 461B
- Rubber bumper provides reliable grip on floor
- A unique assembly design that conceals the axle in the base
- For use with doors up to 3" door-to-floor clearance

No.	Fastener	Base	Projection	Weight
461L	4 ea. #8 x 3/4" OH SMS	2 1/4" x 1 1/4"	5"	5.7 lbs./10

ROCKWOOD®

ASSA ABLOY

Experience a safer
and more open world

800 458 2424 | www.rockwoodmfg.com
Check the web site for the up-to-date catalog

Copyright © 2012–2024, ASSA ABLOY Accessories and Door Controls Group, Inc. All rights reserved. Reproduction in whole or in part without the express written permission of ASSA ABLOY Accessories and Door Controls Group, Inc. is prohibited.



Heavy Duty Door Stop No. 462

Material: Flame resistant high impact bumper
Finishes: US2C
Mounting: Drill 1" dia. x 2 1/2" deep hole, fill with anchoring grout

No.	Diameter	Height	Mounting Bolt	Weight
462	2" dia.	x 1 1/2" h	5/8" x 2 1/2"	0.6 lbs.



Heavy Duty Door Stop No. 463-RKW

Material: Flame resistant high impact bumper
Finishes: US32D
Mounting: Drill 1" dia. x 2 1/2" deep hole, fill with anchoring grout
Other: Replaceable bumper retained by security Torx MS

No.	Diameter	Height	Mounting Bolt	Weight
463-RKW	2" dia.	x 1 3/4" h	1/2" x 2 1/2"	0.5 lbs.



Heavy Duty Door Stop with Holder No. 464-RKW

Material: Cast brass and black rubber bumper
Finishes: US26D
Mounting: Body: 1 ea. 1/2 x 4 1/2" lag bolt; 1 ea. shield;
 2 ea. #8 x 1 1/4" FH SMS.
 Cap: 1 ea. #8 - 32 x 3/8" RH MS
Features: Offers maximum protection needed for heavily used doors.
 Supplied with holder and catch

No.	Diameter	Height	Weight
464-RKW	3 1/4" dia.	x 3" h	1.8 lbs.



Heavy Duty Door Stop No. 465

Material: Wrought brass and black rubber bumper
Finishes: US26D
Mounting: Body: 1 ea. 1/2 x 4 1/2" lag bolt; 1 ea. shield.
 Cap: 1 ea. #8 - 32 x 3/8" RH MS
Features: Offers maximum protection needed for heavily used doors

No.	Diameter	Height	Weight
465	3 1/4" dia.	x 2 5/8" h	1.3 lbs.



Heavy Duty Door Stop No. 466-RKW

- Material:** Flame resistant molded rubber bumper
- Finishes:** Black
- Mounting:** Drill 1" dia. x 2 1/2" deep hole, fill with anchoring grout
- Features:**
- Ideal for use in high vandalism or security areas
 - No exposed fasteners

No.	Diameter	Height	Mounting Bolt	Weight
466-RKW	2" dia.	x 1 1/2" h	5/8" x 2 1/2"	0.6 lbs.



Heavy Duty Door Stop No. 467-RKW

- Material:** Flame resistant molded rubber bumper
- Finishes:** Black
- Mounting:** Drill 1" dia. x 2 1/2" deep hole, fill with anchoring grout
- Features:**
- Suitable for concrete floor or wall mounting
 - Ideal for use in high vandalism or security areas
 - No exposed fasteners
 - Accepted by the New York State Office of Mental Health (OMH) for use in high risk areas

No.	Diameter	Height	Mounting Bolt	Weight
467-RKW	2" dia.	x 3 1/2" h	5/8" x 2 1/2"	0.9 lbs.



Heavy Duty Door Stop No. 468-RKW

- Material:** Wrought stainless steel and black rubber bumper
- Finishes:** US32D
- Mounting:** Drill 1 1/2" dia. x 7" deep hole, fill with anchoring grout
- Features:**
- Ideal for use in high vandalism or security area
 - No exposed fasteners
 - Accepted by the New York State Office of Mental Health (OMH) for use in high risk areas

No.	Diameter	Height	Mounting Bolt	Weight
468-RKW	2" dia.	x 3" h	1" x 7"	2.6 lbs.

ROCKWOOD®

ASSA ABLOY

Experience a safer
and more open world

800 458 2424 | www.rockwoodmfg.com
Check the web site for the up-to-date catalog

Copyright © 2012-2024, ASSA ABLOY Accessories and Door Controls Group, Inc. All rights reserved. Reproduction in whole or in part without the express written permission of ASSA ABLOY Accessories and Door Controls Group, Inc. is prohibited.



No. 471

Door Stops No. 470, 471

- Material:** Cast brass with rubber bumper
- Finishes:** Available in standard architectural finishes (see page 9)
- Options:** Exterior pack screw packs, stainless steel plated to match – use EXP suffix (470xEXP) when ordering

No.	Fastener	Base	Height	Weight
470	3 ea. #12x1 ¹ / ₄ " FH WS; 3 ea. plastic anchors	2 ¹ / ₂ " dia.	3"	0.7 lbs.
471	1 ea. ⁵ / ₁₆ -18x1 ³ / ₄ " stud, anchor; #8x ³ / ₄ " OH SMS, plastic anchor	2 ¹ / ₂ " dia.	3"	0.7 lbs.



No. 473

Door Stops with Keepers No. 472, 473

- Material:** Cast brass with rubber bumper
- Finishes:** Available in standard architectural finishes (see page 9)
- Other:** Keeper size 1" w x 1³/₄" h
- Options:** Exterior pack screw packs, stainless steel plated to match – use EXP suffix (472 x EXP) when ordering

No.	Fastener	Base	Height	Weight
472	3 ea. #12x1 ¹ / ₄ " FH WS; 3 ea. plastic anchors Keeper: 2 ea. #12x1 ¹ / ₄ " FH WS; 2 ea. plastic anchors	2 ¹ / ₂ " dia.	3 ³ / ₄ "	0.9 lbs.
473	⁵ / ₁₆ -18 x 1 ³ / ₄ " stud, anchor; #8x ³ / ₄ " OH SMS, plastic anchor Keeper: 2 ea. #12x1 ¹ / ₄ " FH WS; 2 ea. plastic anchors	2 ¹ / ₂ " dia.	3 ³ / ₄ "	0.9 lbs.

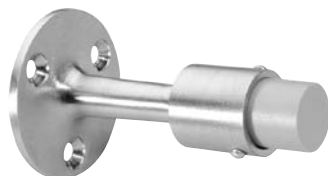

No. 474

Door Stops No. 474, 475

- Material:** Cast brass with rubber bumper
- Finishes:** Available in standard architectural finishes (see page 9)

No.	Fastener	Base	Projection	Weight
474	3 ea. #12x1 ¹ / ₄ " FH WS, 3 ea. plastic anchors	2 ¹ / ₄ " dia.	3 ³ / ₄ "	0.6 lbs.
475	1 ea. ⁵ / ₁₆ -18x1 ³ / ₄ " stud, anchor; #8x ³ / ₄ " OH SMS, plastic anchor	2 ¹ / ₄ " dia.	3 ³ / ₄ "	0.6 lbs.



No. 476

Door Stops with Keepers No. 476, 477

Material: Solid cast brass with rubber bumper

Finishes: Available in standard architectural finishes (see page 9)

Other: Keeper size 1" w x 1³/₄" h

No.	Fastener	Base	Projection	Weight
476	3 ea. #12x1 ¹ / ₄ " FH WS, 3 ea. plastic anchors Keeper: 2 ea. #12x1 ¹ / ₄ " FH WS; 2 ea. plastic anchors	2 ¹ / ₄ " dia.	3 ³ / ₄ "	0.8 lbs.
477	¹⁵ / ₁₆ - 18x1 ³ / ₄ " stud, anchor; #8x ³ / ₄ " OH SMS, plastic anchor Keeper: 2 ea. #12x1 ¹ / ₄ " FH WS; 2 ea. plastic anchors	2 ¹ / ₄ " dia.	3 ³ / ₄ "	0.8 lbs.



Door Stops No. 480

Material: Solid cast brass with rubber bumper

Finishes: Available in standard architectural finishes (see page 9)

Features:

- Uses replacement bumper 461B
- Heavy duty and ideal for use on heavy doors or in high traffic areas

Options:

- Rubber bumper available in standard gray or optional black
- Exterior pack screw packs, stainless steel plated to match — use EXP suffix (480 x EXP) when ordering

No.	Fastener	Base	Height	Weight
480	3 ea. #12 - 24x1 ¹ / ₄ " FH WS, 3 ea Plastic Anchors	2 ¹ / ₂ " x 1 ³ / ₄ "	1 ⁵ / ₈ "	4.6 lbs./10



Door Stops No. 480H

Material: Solid cast brass with rubber bumper

Finishes: Available in standard architectural finishes (see page 9)

Features:

- Uses replacement bumper 461B
- Heavy duty and ideal for use on heavy doors or in high traffic areas

Options:

- Rubber bumper available in standard gray or optional black
- Exterior pack screw packs, stainless steel plated to match — use EXP suffix (480H x EXP) when ordering

No.	Fastener	Base	Height	Weight
480H	3 ea #12 x 1 ¹ / ₄ " FH WS, 3 ea. Plastic Anchors	2 ¹ / ₂ " x 1 ³ / ₄ "	2 ¹ / ₄ "	6.2 lbs./10

ROCKWOOD[®]

ASSA ABLOY

Experience a safer
and more open world

800 458 2424 | www.rockwoodmfg.com
Check the web site for the up-to-date catalog

Copyright © 2012-2024, ASSA ABLOY Accessories and Door Controls Group, Inc. All rights reserved. Reproduction in whole or in part without the express written permission of ASSA ABLOY Accessories and Door Controls Group, Inc. is prohibited.



Door Stops No. 481

- Material:** Solid cast brass with rubber bumper
- Finishes:** Available in standard architectural finishes (see page 9)
- Features:**
- Uses replacement bumper 461B
 - Heavy duty and ideal for use on heavy doors or in high traffic areas
- Options:**
- Rubber bumper available in standard gray or optional black
 - Exterior pack screw packs, stainless steel plated to match – use EXP suffix (481 x EXP) when ordering

No.	Fastener	Base	Height	Weight
481	3 ea. #12 - 24x1" FH MS, 3 ea. anchors	2 $\frac{1}{2}$ " x 1 $\frac{3}{4}$ "	1 $\frac{5}{8}$ "	5.8 lbs./10



Door Stops No. 481H

- Material:** Solid cast brass with rubber bumper
- Finishes:** Available in standard architectural finishes (see page 9)
- Features:**
- Uses replacement bumper 461B
 - Heavy duty and ideal for use on heavy doors or in high traffic areas
- Options:**
- Rubber bumper available in standard gray or optional black
 - Exterior pack screw packs, stainless steel plated to match – use EXP suffix (481H x EXP) when ordering

No.	Fastener	Base	Height	Weight
481H	3 ea. #12 - 24x1" FH MS, 3 ea. anchors	2 $\frac{1}{2}$ " x 1 $\frac{3}{4}$ "	2 $\frac{1}{4}$ "	7.2 lbs./10



Heavy Duty Mounting Plate No. 481MP

- Material:** Aluminum and steel
- Finishes:** Powder coat to match stop finish
- Features:** $\frac{3}{8}$ " aluminum base plate for securely anchoring 481 or 481H door stops in heavy use areas
- Requires 3 $\frac{1}{2}$ " diameter hole 3 $\frac{1}{2}$ " deep. Fill with quick drying cement and set anchor plate flush to finished floor with hole pattern at appropriate location for door stop to interface with door surface

No.	Fastener	Base	Height	Weight
481MP	None	3" dia	Flush to floor	4.5 lbs./10



Door Stop No. 482

Material: Solid cast brass with rubber bumper

Finishes: Available in standard architectural finishes (see page 9)

Features:

- Uses replacement bumper 461B
- Heavy duty and ideal for use on heavy doors or in high traffic areas

Options:

- Rubber bumper available in standard gray or optional black.
- Exterior pack screw packs, stainless steel plated to match – use EXP suffix (482 x EXP) when ordering.

No.	Fastener	Base	Height	Weight
482	$\frac{5}{16}$ - 18 x $1\frac{3}{4}$ " stud, anchor; #12 x $1\frac{1}{4}$ " FH WS, plastic anchor	$1\frac{1}{2}$ " x $2\frac{1}{2}$ "	$2\frac{1}{8}$ "	6.5 lbs./10



Door Stop No. 483

Material: Solid cast brass with rubber bumper

Finishes: Available in standard architectural finishes (see page 9)

Features:

- Uses replacement bumper 461B
- Heavy duty and ideal for use on heavy doors or in high traffic areas

Options:

- Rubber bumper available in standard gray or optional black.
- Exterior pack screw packs, stainless steel plated to match – use EXP suffix (483 x EXP) when ordering.

No.	Fastener	Base	Height	Weight
483	$\frac{5}{16}$ - 18 x $1\frac{3}{4}$ " stud, anchor; #12 x $1\frac{1}{4}$ " FH WS, plastic anchor	$1\frac{5}{8}$ " x $2\frac{5}{8}$ "	$2\frac{3}{4}$ "	6.7 lbs./10



Door Stop with Keeper No. 485

Material: Solid cast brass with rubber bumper

Finishes: Available in standard architectural finishes (see page 9)

Features:

- Uses replacement bumper 461B
- Heavy duty and ideal for use on heavy doors or in high traffic areas

Options:

- Rubber bumper available in standard gray or optional black
- Exterior pack screw packs, stainless steel plated to match – use EXP suffix (485 x EXP) when ordering

No.	Fastener	Base	Height	Weight
485	$\frac{5}{16}$ - 18 x $1\frac{3}{4}$ " stud, anchor; #12 x $1\frac{1}{4}$ " FH WS, plastic anchor Keeper: 2 ea. #10 x 1" FH SMS	$1\frac{5}{8}$ " x $2\frac{5}{8}$ " 1" x 2"	3"	7.8 lbs./10

ROCKWOOD[®]

ASSA ABLOY

Experience a safer
and more open world

800 458 2424 | www.rockwoodmfg.com
Check the web site for the up-to-date catalog

Copyright © 2012–2024, ASSA ABLOY Accessories and Door Controls Group, Inc. All rights reserved. Reproduction in whole or in part without the express written permission of ASSA ABLOY Accessories and Door Controls Group, Inc. is prohibited.



Angle Door Stop No. 486

Material: Steel with rubber bumper

Finishes: US2C

Features: For undercut doors up to 1½"

No.	Fastener	Base	Height	Weight
486	2 ea. #12x1½" FH SMS, 2 ea. plastic anchors	1" x 2½"	2 ⁵ / ₈ "	4 lbs./10



Heavy Duty Wall Stop No. 487

Material: Solid cast brass with rubber bumper

Finishes: US26D

Features: Sloping design resists vandalism

No.	Fastener	Base	Projection	Weight
487	3 ea. #10x1" FH SMS, 3 ea. plastic anchors	2¼" x 3"	3¾"	0.8 lbs.



Door Stop No. 488

Material: Solid brass

Finishes: Available in standard architectural finishes (see page 9)

Features: For single doors

No.	Fastener	Base	Height	Weight
488	2 ea. #12x1½" FH WS, 2 ea. plastic anchors; 2 ea. #12-24x1" FH MS	1½" x 2"	1"	2.2 lbs./10



Door Stop No. 489

Material: Solid brass

Finishes: Available in standard architectural finishes (see page 9)

Features: For single or pair of doors

No.	Fastener	Base	Height	Weight
489	4 ea. #12x1½" FH WS, 4 ea. plastic anchors; 4 ea. #12-24x1" FH MS	3" x 2"	1"	4.1 lbs./10

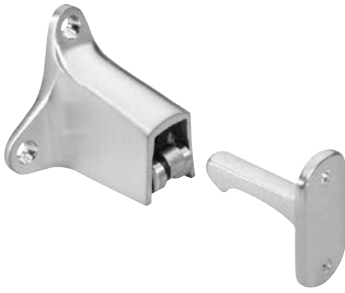

Door Holder with Stop No. 490

- Material:** Cast brass
- Finishes:** US26D
- Other:** Holder base: 2³/₄" w x 2¹/₂" h
 Holder projection: 2¹/₈"
 Strike base: 1" w x 2" h
 Strike projection: 2"

No.	Fastener	Weight
490	5 ea. #10x1" OH SMS, 3 ea. plastic anchors; 3 ea. #10-24x1 ¹ / ₄ " FH MS	0.8 lbs.



Automatic Door Holder with Stop No. 491-RKW, 491R, 491S

- Material:** Cast brass
- Finishes:** Available in standard architectural finishes (see page 9)
- Other:** Holder base: 3" w x 3³/₈" h
 Holder projection: 2¹/₈"
 Strike base: 4" w x 2" h
 Strike projection: 1¹/₄"
- Options:** Strike risers available for larger clearances
- Features:**
- For applications requiring door hold-open on a frequent basis
 - Screw hole design allows for precise alignment and then permanent attachment

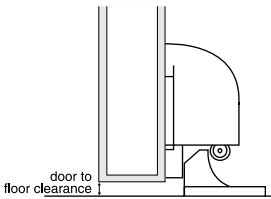

No.	Fastener	Strike	Clearance	Weight
491-RKW	Strike: 3 ea. #12x1 ¹ / ₄ " FH WS, 3 ea. plastic anchors Body: 4 ea. #10x1 ¹ / ₄ " FH WS	Floor	1/2" or less door to floor	1.5 lbs.
491R	Strike: 3 ea. 12-24x1" FH MS, 3 ea. anchors Body: 4 ea. #10x1 ¹ / ₄ " FH WS	Floor	1/2" or less door to floor	1.5 lbs.
491S	Strike: 3 ea. 12-24x1" FH MS, 3 anchors Body: 4 ea. 10-24x1" FH MS; 4 ea. 10-24x1 ³ / ₈ " sex bolt	Floor	1/2" or less door to floor	1.5 lbs.

ROCKWOOD[®]

ASSA ABLOY

Experience a safer
and more open world

800 458 2424 | www.rockwoodmfg.com
Check the web site for the up-to-date catalog

Copyright © 2012-2024, ASSA ABLOY Accessories and Door Controls Group, Inc. All rights reserved. Reproduction in whole or in part without the express written permission of ASSA ABLOY Accessories and Door Controls Group, Inc. is prohibited.



Automatic Door Holder with Stop No. 494-RKW, 494R, 494S

Material: Cast brass

Finishes: Available in standard architectural finishes (see page 9)

Other: Holder base: 3" w x 3³/₈" h
Holder projection: 2¹/₈"
Strike base: 2" w x 3" h
Strike projection: 3¹/₄"

Features:

- For applications requiring door-hold-open on a frequent basis
- Screw hole design allows for precise alignment and then permanent attachment

No.	Fastener	Strike	Clearance	Weight
494-RKW	Strike: 3 ea. #12 x 1 ¹ / ₄ " FH WS, 3 ea. plastic anchors Body: 4 ea. #10 x 1 ¹ / ₄ " FH WS	Wall	3 ³ / ₄ " wall to door	1.7 lbs.
494R	Strike: 3 ea. #12 - 24 x 1" FH MS, 3 ea. anchors Body: 4 ea. #10 x 1 ¹ / ₄ " FH WS	Wall	3 ³ / ₄ " wall to door	1.7 lbs.
494S	Strike: 3 ea. #12 - 24 x 1" FH MS, 3 ea. anchors Body: 4 ea. #10 - 24 x 1" FH MS; 4 ea. #10 - 24 x 1 ³ / ₈ " sex bolt	Wall	3 ³ / ₄ " wall to door	1.7 lbs.

NOTE: 494-RKW can be used as Foot Pull and Holder, see page B35.



Concealed Magnetic Door Stop No. 495

Material: Brass, Low Carbon Steel, Stainless Steel and Polycarbonate with Magnet

Finishes: US26D, Black, Clear

Features:

- Fully concealed magnetic door stop that includes a hold-open function.
- Concealed magnet technology ensures exceptional mechanical functionality.

No.	Fastener	Door Stop Overall	Weight	Material Size
495	2 ea #8 x 1" Stainless Steel Screws	1 ¹³ / ₁₆ "	.37 lbs.	Magnet: 1 ⁹ / ₃₂ " x Ø 1 ⁵ / ₁₆ " Strike Plate: 1 ¹⁵ / ₁₆ " x 3 ⁵ / ₃₂ " Pin: 1-3/4" x Ø 3/8" Floor Insert: 1 ¹¹ / ₁₆ " x Ø 1 ³ / ₃₂ "

800 458 2424 | www.rockwoodmfg.com
Check the web site for the up-to-date catalog

Copyright © 2012-2024, ASSA ABLOY Accessories and Door Controls Group, Inc. All rights reserved. Reproduction in whole or in part without the express written permission of ASSA ABLOY Accessories and Door Controls Group, Inc. is prohibited.

ROCKWOOD®
ASSA ABLOY

Experience a safer
and more open world



Door Stops No. 505-RKW, 508

Material: Cast brass with rubber bumper

Finishes: Available in standard architectural finishes (see page 9).

Options: Rubber bumper available in standard white or optional gray and black

No.	Fastener	Base	Projection	Weight
505-RKW	#10 - 24 x 1 1/4" hanger bolt	1" dia.	3 1/8"	1.6 lbs./10
508	#10 - 24 x 1 1/4" hanger bolt	1" dia.	4 3/16"	2.2 lbs./10



Aluminum Door Stop No. 517

Material: Cast aluminum with rubber bumper

Finishes: Bright brass (BRS) and burnished aluminum (ALM)

Options: Rubber bumper available in standard white or optional gray and black

No.	Fastener	Base	Projection	Weight
517	2 ea. #8 x 3/4" OH SMS	1 1/2" dia.	3 3/4"	1.1 lbs./10



Door Stop No. 518

Material: Cast brass with rubber bumper

Finishes: Available in standard architectural finishes (see page 9)

Options: Rubber bumper available in standard white or optional gray and black

No.	Fastener	Base	Projection	Weight
518	2 ea. #8 x 3/4" OH SMS	1 1/2" dia.	3 3/4"	1.9 lbs./10



Door Stop No. 519

Material: Cast brass with rubber bumper

Finishes: Available in standard architectural finishes (see page 9)

Options: Rubber bumper available in standard white or optional gray and black

No.	Fastener	Base	Projection	Weight
519	#10 - 24 x 1 1/4" hanger bolt	1 1/4" dia.	3 1/4"	1.7 lbs./10



Replacement Bumper No. 520

Material: Rubber bumper

Weight: 0.7 lbs./10.

Other: Bumper replacement for No. 505, 508, 517, 518, 519.

Options: Available in standard white or optional gray and black.

ROCKWOOD[®]

ASSA ABLOY

Experience a safer
and more open world

800 458 2424 | www.rockwoodmfg.com
Check the web site for the up-to-date catalog

Copyright © 2012-2024, ASSA ABLOY Accessories and Door Controls Group, Inc. All rights reserved. Reproduction in whole or in part without the express written permission of ASSA ABLOY Accessories and Door Controls Group, Inc. is prohibited.



Spring Base Door Stop No. 525

Material: Spring steel

Finishes: Antique brass (ANT) with White bumper, bright brass (BRS) with White bumper, bright nickel (NP) with White bumper, black (BLK) with Black bumper

Features: Heavy spring construction for durable wear

No.	Fastener	Base	Projection	Weight
525	6 x 3/4" SMS	1" dia.	3"	0.7 lbs./10



Spring Base Door Stop No. 526

Material: Spring steel

Spring Finishes: Bright brass (BRS), bright nickel (NP)

Rubber bumper color: White

Features: Heavy spring construction for durable wear

No.	Fastener	Base	Projection	Weight
526	6 x 3/4" SMS	1" dia.	4"	0.8 lbs./10



Heavy Duty Hinge Pin Stop No. 528

Material: Wrought steel with rubber bumpers

Finishes: Antique brass (ANT), bright brass (BRS), bright nickel (NP)

Features:

- Positive slip proof adjustment
- Heavy wrought steel construction works with both 1/4" and 5/16" hinge pins

No.	Door Opening Adjustment	Weight
528	70° to 100°	1.3 lbs./10

Introduction to Overhead Stops & Holders

Rockwood Overhead Stops and Holders are used to extend the life of the door, frame and any door closing devices. They may be necessary if there are strong winds, high traffic or abuse.

- When used in conjunction with a floor closer, you have absolute door control, top and bottom.
- Provides positive deadstop at selected degree
- There are 2 functions, 3 ways to order:
 - Hold Open** – door remains held open near deadstop location
 - Stops** – door deadstops at a particular degree of opening
 - Multi Function** – adaptable as hold open and/or stops
- Available as surface mounted or concealed
- Standard mount on push side of door (See model descriptions for pull side installations)
- Thru bolts are furnished with all surface models and must be used for installation

WARNING: HOLD OPEN FUNCTION CANNOT BE USED ON LABELED OPENINGS!

To Convert from Hold Open to Stop Function:

1. Remove the plastic end cap (#1) at the spring end of the channel.
2. With $\frac{3}{16}$ " hex key wrench, loosen the set screw in shock block.
3. Remove the shock block plate and the hold open spring from channel.
4. Remove the hold open spring from the shock block.
5. Replace the shock block and block plate into channel.
6. Replace the plastic end cap.
7. Install unit on door.
8. Adjust to desired opening and tighten set screw.

To Select Degree of Stop (Hold Open Models):

1. Engage door in hold open position.
2. Using a $\frac{3}{16}$ " hex wrench, loosen the set screw in the shock block.
3. Open door to desired degree of opening.
4. Tighten set screw.
5. Verify door opening position and re-adjust, if needed.

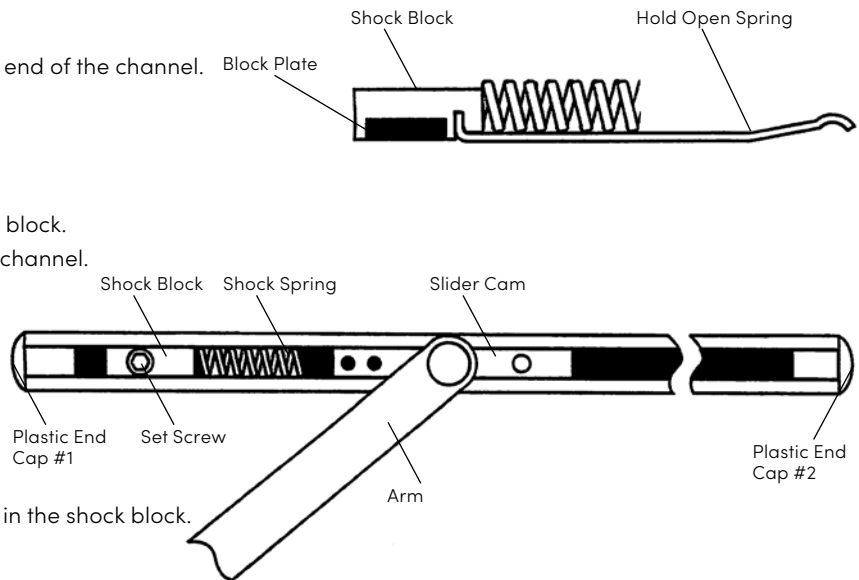

ROCKWOOD®

ASSA ABLOY

Experience a safer
and more open world

800 458 2424 | www.rockwoodmfg.com
Check the web site for the up-to-date catalog

Copyright © 2012-2024, ASSA ABLOY Accessories and Door Controls Group, Inc. All rights reserved. Reproduction in whole or in part without the express written permission of ASSA ABLOY Accessories and Door Controls Group, Inc. is prohibited.



Heavy Duty Concealed OH100 Series

Material: Stainless steel

Finishes: US32D, 10BE

Fasteners: Jamb: 1/4" -20 x 3/4" FH MS or #14 x 1 1/2" FH WS
Door: 5/16"-18 x 1 1/2" FH MS or #18 x 3" FH WS

- Features:**
- Doors may be single or double acting
 - Non-handed
 - Slide track design
 - Recommended for high traffic, heavy abuse installations
 - Heavy shock absorber spring provides 5-7° compression before deadstop
 - Surface on/off knob on hold open models
 - Complete screw packet for installation in wood and machine screws for door and frame
 - For security areas, Torx® screws available for exposed fasteners.
 - Durable slider cam and shock block
 - 110° maximum opening
 - 3/4" minimum door thickness, for thicker doors, note thickness when ordering
 - 3/16" square channel
 - Stop function UL listed for fire door assemblies

No.	Function	Door Opening		Weight
		Butts/Offset Pivots	Center Hung	
OH101H	Hold open	24" - 28"	-	4.5 lbs.
OH102H	Hold open	28 1/16" - 33"	30" - 36"	4.5 lbs.
OH103H	Hold open	33 1/16" - 38"	36 1/16" - 41"	4.5 lbs.
OH104H	Hold open	38 1/16" - 43"	41 1/16" - 46"	4.5 lbs.
OH105H	Hold open	43 1/16" - 48"	46 1/16" - 50"	4.5 lbs.
OH101S	Stop only	24" - 28"	-	4.5 lbs.
OH102S	Stop only	28 1/16" - 33"	30" - 36"	4.5 lbs.
OH103S	Stop only	33 1/16" - 38"	36 1/16" - 41"	4.5 lbs.
OH104S	Stop only	38 1/16" - 43"	41 1/16" - 46"	4.5 lbs.
OH105S	Stop only	43 1/16" - 48"	46 1/16" - 50"	4.5 lbs.

800 458 2424 | www.rockwoodmfg.com

Check the web site for the up-to-date catalog

Copyright © 2012-2024, ASSA ABLOY Accessories and Door Controls Group, Inc. All rights reserved. Reproduction in whole or in part without the express written permission of ASSA ABLOY Accessories and Door Controls Group, Inc. is prohibited.

ROCKWOOD®

ASSA ABLOY

Experience a safer
and more open world



Standard Duty Concealed OH200 Series

Material: Stainless steel

Finishes: US32D, 10BE

Fasteners: Jamb: #12-24 x 1/2" FH MS or #12 x 1 1/2" FH WS
Door: #12-24 x 1 1/2" FH MS or #12 x 1 1/2" FH WS

- Features:**
- Doors may be single or double acting
 - Non-handed
 - Slide track design
 - Recommended for medium traffic, medium weight doors
 - Degree of opening is fully adjustable and can be adapted to changing needs
 - Heavy shock absorber spring provides 5-7° compression before deadstop
 - Multi-function unit is shipped as a stop. Can be converted to a hold open or friction in the field. MF5012 KIT (Adapter kit) included
 - Complete screw packet kit for installation in wood or metal door and frame
 - For security areas, Torx® screws available for exposed fasteners, but heavy-duty units should be considered for high security applications
 - Durable slider cam and shock block
 - 110° maximum opening
 - 3/4" square channel
 - Stop function UL listed for fire door assemblies

No.	Function	Door Opening		Weight
		Butts/Offset Pivots	Center Hung	
OH201M	Multi-function	18" - 24"	-	3.5 lbs.
OH202M	Multi-function	24 1/16" - 30"	27" - 32"	3.5 lbs.
OH203M	Multi-function	30 1/16" - 36"	32 1/16" - 38 1/2"	3.5 lbs.
OH204M	Multi-function	36 1/16" - 42"	38 9/16" - 45"	3.5 lbs.
OH205M	Multi-function	42 1/16" - 48"	45 1/16" - 48"	3.5 lbs.

ROCKWOOD®

ASSA ABLOY

Experience a safer
and more open world

800 458 2424 | www.rockwoodmfg.com
Check the web site for the up-to-date catalog

Copyright © 2012-2024, ASSA ABLOY Accessories and Door Controls Group, Inc. All rights reserved. Reproduction in whole or in part without the express written permission of ASSA ABLOY Accessories and Door Controls Group, Inc. is prohibited.



Heavy Duty Surface Mounted OH900 Series

Material: Stainless steel

Finishes: US32D, 10BE

Fasteners: Jamb: $\frac{1}{4}$ -20 x $\frac{3}{4}$ " FH MS or #14 x $1\frac{1}{2}$ " FH WS
Door: $\frac{5}{16}$ -18 x 2" FH MS and $\frac{1}{2}$ " dia. sex bolt

- Features:**
- Doors are single acting
 - Non-handed
 - Slide track design
 - Recommended for high traffic, heavy abuse installations
 - Heavy shock absorber spring provides 5-7° compression before deadstop
 - On/off knob on hold open models
 - Complete screw packet with thru-bolts for door, wood and machine screws for frame
 - Torx® screws optional for security applications
 - Durable slider cam and shock block
 - 110° maximum opening
 - $1\frac{3}{4}$ " minimum door thickness
 - $1\frac{3}{16}$ " square channel
 - Stop function UL listed for fire door assemblies
 - For pull side mounting or flush mounting on push side or for rabbeted push side use angle jamb bracket adapter JB900LH or JB900RH

No.	Function	Door Opening		Weight
		Butts/Offset Pivots	Center Hung	
OH901H	Hold open	24" - 28"	-	4.5 lbs.
OH902H	Hold open	28 $\frac{1}{16}$ " - 33"	30" - 36"	4.5 lbs.
OH903H	Hold open	33 $\frac{1}{16}$ " - 38"	36 $\frac{1}{16}$ " - 41"	4.5 lbs.
OH904H	Hold open	38 $\frac{1}{16}$ " - 43"	41 $\frac{1}{16}$ " - 46"	4.5 lbs.
OH905H	Hold open	43 $\frac{1}{16}$ " - 48"	46 $\frac{1}{16}$ " - 50"	4.5 lbs.
OH901S	Stop only	24" - 28"	-	4.5 lbs.
OH902S	Stop only	28 $\frac{1}{16}$ " - 33"	30" - 36"	4.5 lbs.
OH903S	Stop only	33 $\frac{1}{16}$ " - 38"	36 $\frac{1}{16}$ " - 41"	4.5 lbs.
OH904S	Stop only	38 $\frac{1}{16}$ " - 43"	41 $\frac{1}{16}$ " - 46"	4.5 lbs.
OH905S	Stop only	43 $\frac{1}{16}$ " - 48"	46 $\frac{1}{16}$ " - 50"	4.5 lbs.

800 458 2424 | www.rockwoodmfg.com

Check the web site for the up-to-date catalog

Copyright © 2012-2024, ASSA ABLOY Accessories and Door Controls Group, Inc. All rights reserved. Reproduction in whole or in part without the express written permission of ASSA ABLOY Accessories and Door Controls Group, Inc. is prohibited.

ROCKWOOD®

ASSA ABLOY

Experience a safer
and more open world

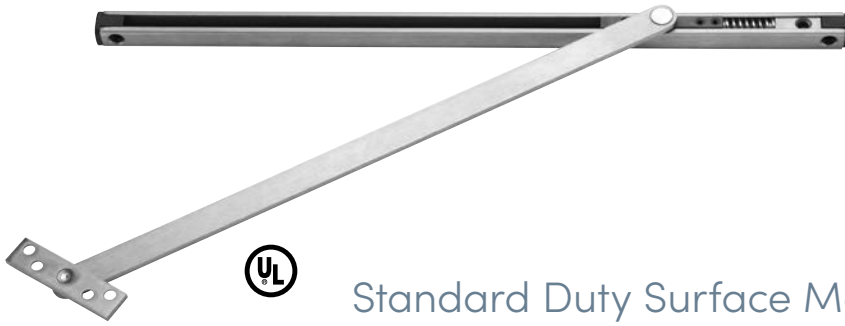

Standard Duty Surface Mounted OH1000 Series

Material: Stainless steel

Finishes: US32D, 10BE

Fasteners: Jamb: #12 x 1½" FH WS or #12-24 x ½" FH MS
Door: #12-24 x 1½" FH MS and 5/16" dia. sex bolt

- Features:**
- Single acting doors
 - Non-handed
 - Slide track design
 - Recommended for medium traffic, medium weight doors
 - Degree of opening fully adjustable and can be adapted to changing needs
 - Heavy shock absorber spring provides compression before deadstop
 - Multi-function unit is shipped as a stop. Can be converted to a hold open or friction in field. MF5012 KIT (Adapter kit) included
 - Complete screw packet with thru-bolts for door, wood and machine screws for frame
 - Torx® screws optional for security applications, but heavy-duty units should be considered for high-security applications
 - Durable slider cam and shock block
 - 110° maximum opening
 - ¾" square channel
 - Stop function UL listed for fire door assemblies
 - For pull side mounting or flush and rabbeted mounting on push side use angle jamb bracket adapter JB1000

Door Opening

No.	Function	Butts/Offset Pivots	Center Hung	Weight
OH1001M	Multi-function	18" - 24"	21" - 26½"	3.5 lbs.
OH1002M	Multi-function	24½" - 30"	26⅞" - 32"	3.5 lbs.
OH1003M	Multi-function	30½" - 36"	32½" - 38"	3.5 lbs.
OH1004M	Multi-function	36½" - 42"	38½" - 45"	3.5 lbs.
OH1005M	Multi-function	42½" - 48"	45½" - 48"	3.5 lbs.

ROCKWOOD®

ASSA ABLOY

Experience a safer
and more open world

800 458 2424 | www.rockwoodmfg.com
Check the web site for the up-to-date catalog

Copyright © 2012-2024, ASSA ABLOY Accessories and Door Controls Group, Inc. All rights reserved. Reproduction in whole or in part without the express written permission of ASSA ABLOY Accessories and Door Controls Group, Inc. is prohibited.



Lever Extension Flush Bolt No. 550

Material: Brass

Finishes: Available in standard architectural finishes (see page 9)

Fastener: 8 ea. #8 x 3/4" FH combo screws

Features:

- For Fire Rated Hollow Metal Swinging Doors measuring up to 4'w x 10'h rated up to and including 3 Hours
- 3/4" bolt throw, 3/4" rod backset
- 12" rod length (center of face to bolt end - retracted)
- 1 1/2" adjustable bolt head

Options:

- Other size rods available are 18", 24", 36", 48"
- Use No. 570 Dust Proof Strike (shown on page E4) to prevent dirt blocking bottom strike

No.	Size	Weight
550	Face plate: 1 1/4" x 6 3/4" Strike: 15/16" x 2 1/4" Guide: 1" x 2"	1.7 lbs./2



Rabbit Piece No. 554

Material: Brass

Finishes: Available in standard architectural finishes (see page 9)

Fastener: 2 ea. #8 x 1 1/4" FH WS

Other: For use on rabbeted doors to fill mortise cut

No.	Size	Weight
554	1/2" x 6 3/4"	1.5 lbs./10

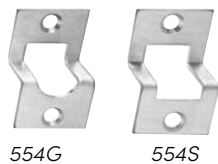

554G

554S

Rabbit Guides No. 554G, 554S

Material: Brass

Finishes: Brass

Fastener: 2 ea. #6 x 3/4" FH combo screws

ROCKWOOD®

ASSA ABLOY

Experience a safer
and more open world



Lever Extension Flush Bolt No. 555

Material: Brass

Finishes: Available in standard architectural finishes (see page 9)

Fastener: 8 ea. #8x³/₄" FH combo screws

- Features:**
- For Fire Rated Hollow Metal Swinging Doors measuring up to 4'w x 10'h rated up to and including 3 Hours
 - Fits ANSI A115 door and frame preparation
 - ³/₄" bolt throw, ³/₄" rod backset
 - 12" rod length (center of face to bolt end - retracted)
 - 1¹/₂" adjustable bolt head

- Options:**
- Other size rods available are 18", 24", 36", 48"
 - Extra long bolt head - 2¹/₂" (or to your specification)
 - Use No. 570 Dust Proof Strike (shown on page E4) to prevent dirt blocking bottom strike

No.	Size	Weight
555	Face plate: 1" x 6 ³ / ₄ " Strike: ¹⁵ / ₁₆ " x 2 ¹ / ₄ " Guide: 1" x 2"	1.5 lbs./2



Lever Extension Flush Bolt with Bottom Fire Bolt No. 555x18BFB

Material: Flush bolt - brass
Bottom fire bolt - stainless steel

Finishes: Available in standard architectural finishes (see page 9)

Fastener: 8 ea. #8x³/₄" FH combo screws

- Features:**
- For Fire Rated Hollow Metal Swinging Doors measuring up to 4'w x 9'h rated up to and including 3 Hours
 - Fits ANSI A115 door and frame preparation
 - ³/₄" bolt throw, ³/₄" rod backset
 - 12" rod length (center of face to bolt end - retracted)
 - 1¹/₂" adjustable bolt head
 - When door is subjected to 230° F the plug and black plastic cover will melt allowing the bolt to project, locking the leaves together
 - Bottom fire bolt eliminates need for floor prep.
 - Oversize fire bolt strike hole allows for slight door misalignment

- Options:**
- Other size rods available are 18", 24", 36", 48"
 - Extra long bolt head - 2¹/₂" (or to your specification)

No.	Size	Weight
555 x 18BFB	Top bolt: 1" x 6 ³ / ₄ " Bottom bolt: ¹³ / ₁₆ " dia.	0.9 lbs.

ROCKWOOD®

ASSA ABLOY

Experience a safer
and more open world

800 458 2424 | www.rockwoodmfg.com
Check the web site for the up-to-date catalog

Copyright © 2012-2024, ASSA ABLOY Accessories and Door Controls Group, Inc. All rights reserved. Reproduction in whole or in part without the express written permission of ASSA ABLOY Accessories and Door Controls Group, Inc. is prohibited.



Lever Extension Flush Bolt No. 556WS Windstorm

The Rockwood 556WS Flush Bolt is part of a UL certified assembly from ASSA ABLOY. Listed for use on both in-swing or out-swing paired applications, the full assembly includes doors from Ceco Door, Curries or Fleming and latching hardware from Corbin Russwin, SARGENT or ASSA ABLOY ACCENTRA™.

Material: Brass and Stainless Steel

Finishes: 26D

Fastener: 8 ea. #8 - 32 x 1/4" FH MS in Stainless Steel

Features:

- 3/4" bolt throw, 3/4" rod backset
- 12" Stainless Steel rod length (center of face to bolt end - retracted).
- UL Certified
- Tested to ASTM E330, E1886, E1996 and the TAS 201, 202, and 203. Assembly approved for use in the state of Florida including the High Velocity Hurricane Zone (HVHZ)

No.	Size	Material	Weight
556WS	Face plate: 1" x 6 3/4" x 1/8"	Brass	2.5 lbs./2
	Mortise Body 1" x 5 1/4" x 1 3/8"	Brass	
	Rod 12" x 1/2"D	Stainless Steel	
	Strike: 1 5/16" x 2 1/4"	Stainless Steel	
	Guide: 1" x 2"	Stainless Steel	



Lever Extension Flush Bolt No. 557

Material: Cast brass

Finishes: Available in standard architectural finishes (see page 9)

Fastener:

- 7 ea. #8 x 3/4" FH combo screws
- 4 ea. #8 - 32 x 1/2" FH MS
- 4 ea. #8 counter sunk washer

Features:

- For Fire Rated Plastic & Wood Covered Doors measuring up to 4'w x 10'h rated up to and including 1 1/2 Hours
- 3/4" bolt throw, 3/4" backset; door strength maintained by corner reinforcing plate

Options: Use No. 570 Dust Proof Strike (shown on page E4) to prevent dirt blocking bottom strike

No.	Size	Weight
557	Face plate: 1" x 6 3/4" Strike: 1 5/16" x 2 1/4"	1.7 lbs./2



800 458 2424 | www.rockwoodmfg.com
Check the web site for the up-to-date catalog

Copyright © 2012-2024, ASSA ABLOY Accessories and Door Controls Group, Inc. All rights reserved. Reproduction in whole or in part without the express written permission of ASSA ABLOY Accessories and Door Controls Group, Inc. is prohibited.

ROCKWOOD®
ASSA ABLOY

Experience a safer
and more open world

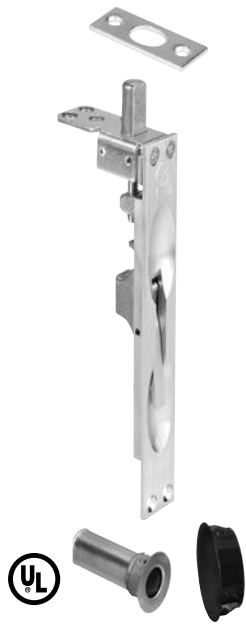

Lever Extension Flush Bolt With Bottom Fire Bolt No. 557 x 19BFB

Material: Flush bolt – brass
Bottom fire bolt – stainless steel

Finishes: Available in standard architectural finishes (see page 9)

Fastener: 7 ea. #8 x 3/4" FH combo screws
4 ea. #8 - 32 x 1/2" FH MS
4 ea. #8 counter sunk washer

Features:

- For Fire Rated Plastic & Wood Covered Fire Doors measuring up to 4'w x 9'h rated up to 20 minutes
- 3/4" bolt throw, 3/4" backset; door strength maintained by corner reinforcing plate
- When door is subjected to 230°F the plug and black plastic cover will melt allowing the bolt to project, locking the leaves together
- Bottom fire bolt eliminates need for floor prep
- Oversize fire bolt strike hole allows for slight door misalignment

No.	Size	Weight
557 x 19BFB	Top bolt: 1" x 6 3/4" Bottom bolt: 1 3/16" dia.	0.9 lbs.



Dust Proof Strike No. 570

Material: Brass

Finishes: Available in standard architectural finishes (see page 9)

Fastener: Adjustment nut
Spanner wrench
2 ea. #8 x 1 OH SMS, 2 ea. plastic anchors
2 ea. #8 - 32 x 3/4" OH MS, 2 ea. anchors

Features:

- Works with all Rockwood manual and automatic flush bolts
- Removable face plate for use with thresholds
- Adjustable height for carpeted areas

No.	Size	Weight
570	Face plate: 1 3/8" x 2 7/8" Barrel: 3/4" dia. x 2" depth	0.4 lbs.

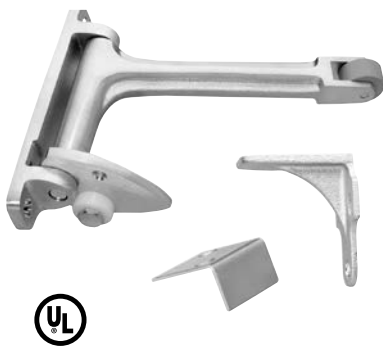

Gravity Door Coordinator No. 576

Material: Cast brass

Finishes: Available in standard architectural finishes (see page 9).

Fastener: Body: 2 ea. #10 x 1" FH SMS, 2 ea. #10 - 24 x 1" FH MS
Strike: 5 ea. #8 x 1" FH SMS

Other:

- For use on door sizes:
 - with Astragal on active door – 18" to 48"
 - with Astragal on inactive door – 18" to 34"
 - with Astragal on both doors – 18" to 30"
- The overlap of the astragal is maximum 7/8" with door hung on standard hinges. Customer must contact the factory for all other astragal situations

Features: Non-handed reversible. Prevents the active door from closing until the inactive door is closed

No.	Size	Projection	Weight
576	1" x 5 7/16"	7"	2.2 lbs.

ROCKWOOD®

ASSA ABLOY

Experience a safer
and more open world

800 458 2424 | www.rockwoodmfg.com
Check the web site for the up-to-date catalog

Copyright © 2012-2024, ASSA ABLOY Accessories and Door Controls Group, Inc. All rights reserved. Reproduction in whole or in part without the express written permission of ASSA ABLOY Accessories and Door Controls Group, Inc. is prohibited.

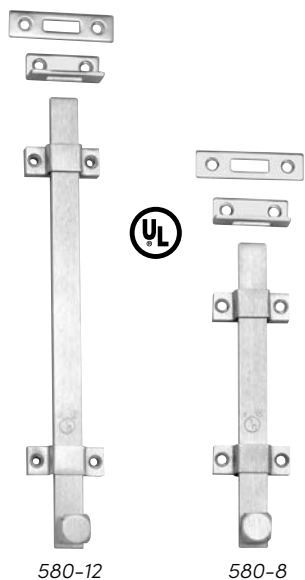

580-12

580-8

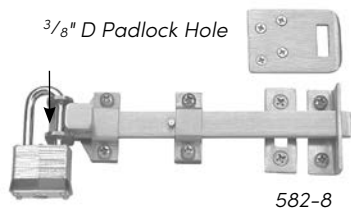

582-8

Surface Bolts No. 580, 582 Series

Material: No. 580: Steel, stainless steel
No. 582: Stainless steel

Finishes: US3, US10B, US26D, US32D, 10BE, BSP, WSP, BPC, WPC

Fastener: No. 580: 8 ea. #10x1¼" FH SMS, 8 ea. #10-24x1" FH MS
No. 582: Bolt: 4 ea. #10-24x1½" PH MS; 4 ea. #10x1¼" PH WS
Strikes: 6 ea. #10-32x1½" FH MS; 6 ea. #10-32x1½" FH WS

Other: 1⅛" bolt throw, ¼"x¾" bolt material

Features:

- No. 580 Series bolts are UL listed for use on inactive leaf of a pair of 3-hour labeled fire doors
- No. 580 and No. 582 series both include a universal top strike and a mortise bottom strike
- No. 582 Series has a bracket for padlock (padlock not included)

Options: Sex bolts available for extra secure mounting

No.	Bolt Length	Weight
580-8	8"	1.1 lbs.
580-12	12"	1.4 lbs.
580-18	18"	1.7 lbs.
580-24	24"	2.0 lbs.
582-8	8"	1.3 lbs.
582-12	12"	1.6 lbs.

Heavy Duty Surface Bolts No. 585 Series

Material: Steel

Finishes: US26D, 10BE, BSP, WSP, BPC, WPC, FBPC, RPC, 314E, 315E

Fastener: Bolt: 4 ea. ¼-20x2¼" FH MS
4 ea. ¼-20x1⅝" sex bolts
Strike: 2 ea. #14x2½" FH SMS, 2 ea. Plastic Anchors
2 ea. ¼-20x1" FH MS, 2 ea. ¼-20 Anchors

Other: 1¼" bolt throw, ¾"x¾" bolt material

Features:

- *UL listed up to 24" bolt size for use on inactive leaf of a pair of 3-hour labeled fire doors
- Includes a universal top strike and a mortise bottom strike
- Locks in both the up and down position
- Bolt locks automatically when thrown – can be released only by pressing knob toward door while retracting
- Can be used on any type of door
- Accommodates padlock

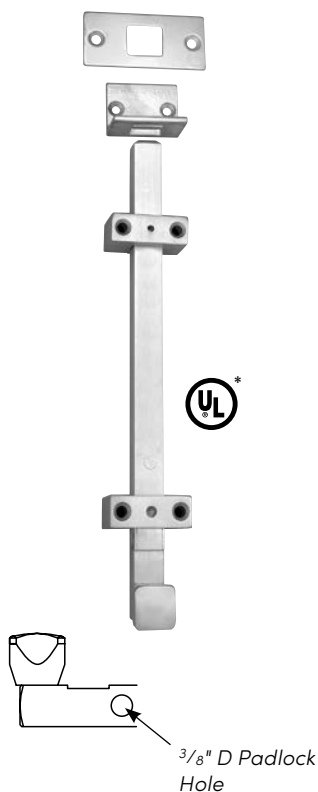

No.	Bolt Length	Weight
585-12	12"	3.9 lbs.
585-24	24"	6.1 lbs.
585-36	36"	8.3 lbs.
585-48	48"	10.5 lbs.

800 458 2424 | www.rockwoodmfg.com
Check the web site for the up-to-date catalog

Copyright © 2012-2024, ASSA ABLOY Accessories and Door Controls Group, Inc. All rights reserved. Reproduction in whole or in part without the express written permission of ASSA ABLOY Accessories and Door Controls Group, Inc. is prohibited.

ROCKWOOD®
ASSA ABLOY

Experience a safer
and more open world

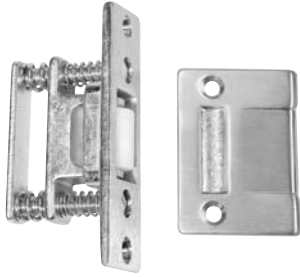

Roller Latch with Cast Strike No. 590

- Material:** Cast brass
- Finishes:** Available in standard architectural finishes (see page 9)
Roller in white or black contingent on specified finish
- Fastener:** Body: 2 ea. #8 x 3/4" FH combo screws
Strike: 2 ea. #8 x 3/4" FH combo screws
- Features:**
- Solid nylon roller for durable silent operation
 - Simple adjustment for roller projection

No.	Latch Face	Strike	Weight
590	1" x 3 3/8"	1 11/16" x 2 1/4"	0.6 lbs.

Double Acting Strike No. 590DA

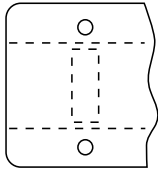

- Material:** Brass
- Finishes:** Available in standard architectural finishes (see page 9)
- Fastener:** Strike: 4 ea. #8 x 3/4" FH combo screws
- Other:** For use on double acting doors and frames with the No. 590
Specify size required
- Features:**
- Solid nylon roller for durable silent operation
 - Simple adjustment for roller projection

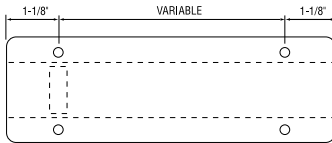

No.	Latch Face	Strike	Weight
590DA (Strike Only)	1" x 3 3/8"	2 3/4" x specify	0.6 lbs.

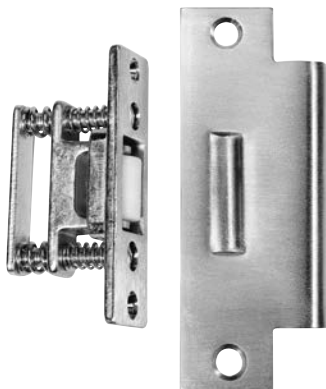

Roller Latch with ASA Strike No. 591

- Material:** Cast brass
- Finishes:** Available in standard architectural finishes (see page 9)
Roller in white or black contingent on specified finish
- Fastener:** Body: 2 ea. #8 x 3/4" FH combo screws
Strike: 2 ea. #12 - 24 x 1/2" FH MS
- Features:**
- Solid nylon roller for durable silent operation
 - Simple adjustment for roller projection

No.	Latch Face	Strike	Weight
591	1" x 3 3/8"	1 1/4" x 4 7/8"	0.6 lbs.

ROCKWOOD

ASSA ABLOY

Experience a safer
and more open world

800 458 2424 | www.rockwoodmfg.com
Check the web site for the up-to-date catalog

Copyright © 2012-2024, ASSA ABLOY Accessories and Door Controls Group, Inc. All rights reserved. Reproduction in whole or in part without the express written permission of ASSA ABLOY Accessories and Door Controls Group, Inc. is prohibited.

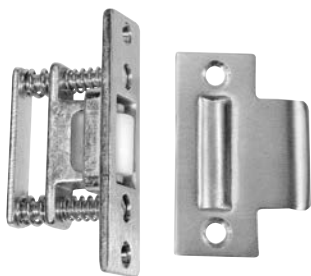

Roller Latch with No. 161 Strike No. 592

- Material:** Cast brass
- Finishes:** Available in standard architectural finishes (see page 9)
Roller in white or black contingent on specified finish
- Fastener:** Body: 2 ea. #8 x³/₄" FH combo screws
Strike: 2 ea. #8 x³/₄" FH combo screws
- Features:**
- Solid nylon roller for durable silent operation
 - Simple adjustment for roller projection
 - Accepted by the New York State Office of Mental Health (OMH) for use in high risk areas

No.	Latch Face	Strike	Weight
592	1" x 3 ³ / ₈ "	1 ¹ / ₈ " x 2 ³ / ₄ "	0.6 lbs.



Roller Latch with Angle Stop No. 593

- Material:** Cast brass.
- Finishes:** Available in standard architectural finishes (see page 9)
Roller in white or black contingent on specified finish
- Fastener:** Body: 2 ea. #12 x 1¹/₂" FH WS
Strike: 2 ea. #8 x³/₄" FH combo screws
- Features:**
- Mounts in header with strike in top of door
 - Solid nylon roller for durable silent operation
 - Simple adjustment for roller projection

No.	Latch Face	Strike	Projection	Weight
593	1 ¹ / ₂ " x 4 ¹ / ₂ "	1 ¹ / ₈ " x 2 ¹ / ₄ "	5 ⁵ / ₈ "	0.8 lbs.

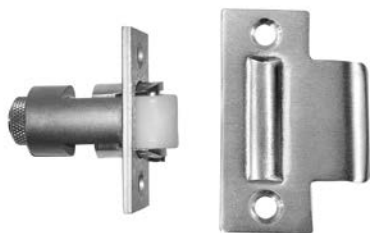

Roller Latch with No. 161 Strike No. 594

- Material:** Cast brass
- Finishes:** Available in standard architectural finishes (see page 9)
- Fastener:** Body: 2 ea. #8 x³/₄" FH combo screws
Strike: 2 ea. #8 x³/₄" FH combo screws
- Features:**
- Solid nylon roller for durable silent operation
 - Simple adjustment for roller projection

No.	Latch Face	Strike	Weight
594	1 ¹ / ₈ " x 2 ¹ / ₄ "	1 ¹ / ₈ " x 2 ³ / ₄ "	0.7 lbs.



Secret Gate Latch No. 602

- Material:** Cast brass
- Finishes:** US4, US10, US10B, 10BE, US26D
- Features:**
- Single acting, reversible. Supplied with dummy knob
 - Bolt activated by pressing button concealed on bottom of latch case

No.	Fastener	Size	Weight
602	5 ea. #7x1 ¹ / ₄ " OH WS	Case: 2 ¹ / ₁₆ " x 2 ⁷ / ₁₆ " Strike: 2 ¹ / ₁₆ " x 3 ³ / ₄ "	3.4 lbs./6

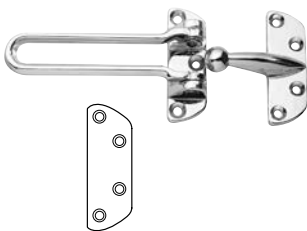

Door Guard No. 603

- Material:** Cast aluminum
- Finishes:** Antique brass (ANT), bright brass (BRS), bright chrome (CRM)
- Options:** 1/8" clear plastic shim - order separately as 603 SHIM

No.	Fastener	Size	Weight
603	Body: 3 ea. #6x1 ¹ / ₂ " FH SMS Strike: 4 ea. #6 x 1" FH SMS	Body: 2 ⁹ / ₃₂ " x 2 ¹ / ₂ " Strike: 3 ¹ / ₃₂ " x 2 ¹ / ₂ "	3.3 lbs./10
603 SHIM		3 ¹ / ₃₂ " x 2 ¹ / ₂ "	

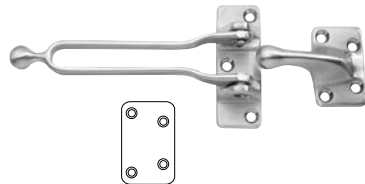

Door Guard No. 604

- Material:** Solid cast brass
- Finishes:** US3, US4, US10, US10B, US26, US26D, US15
- Options:** 1/8" clear plastic shim - order separately as 604 SHIM

No.	Fastener	Size	Weight
604	Body: 3 ea. #6x1 ¹ / ₂ " OH SMS Strike: 4 ea. #6x ³ / ₄ " OH SMS	Body: 1 ¹ / ₁₆ " x 2 ⁹ / ₁₆ " Strike: 1 ⁵ / ₈ " x 1 ¹ / ₁₆ "	4.4 lbs./10
604 SHIM		1 ¹ / ₁₆ " x 1 ¹ / ₁₆ "	



Door Guard Protection Plates No. 605, 605SMS

- Material:** Brass
- Finishes:** US3, US4, US10, US10B, US15, US26, US26D, Stock Powder Coats
- Features:** Protects corner of door from damage by door guard arm

No.	Fastener	Size	Weight
605	Self-adhesive tape	1 ¹ / ₈ " x 1" x 1 ¹ / ₂ " return	0.3 lbs./10
605SMS	#6x ⁵ / ₈ " FH SMS	1 ¹ / ₈ " x 1" x 1 ¹ / ₂ " return	0.3 lbs./10

ROCKWOOD

ASSA ABLOY

Experience a safer
and more open world

800 458 2424 | www.rockwoodmfg.com
Check the web site for the up-to-date catalog

Copyright © 2012-2024, ASSA ABLOY Accessories and Door Controls Group, Inc. All rights reserved. Reproduction in whole or in part without the express written permission of ASSA ABLOY Accessories and Door Controls Group, Inc. is prohibited.

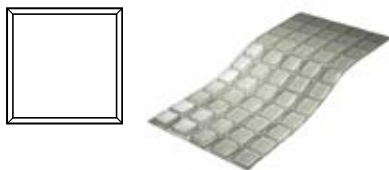

Wall Guard No. 606-RKW

Material: Clear rubber

Other: Sold in sheets of 55

Features: Self-adhesive mounting

No.	Fastener	Size	Weight
606-RKW	Self-adhesive back	1" x 1"	0.4 lbs./55



Privacy Door Latch No. PDLAA

Material: Zinc die cast

Finishes: US26D, US26, US15, BSP, US3, US4, 10BE

Features:

- ADA compliant
- Enhanced in room privacy
- Easy to install
- For use with UL Classified fire doors for use with hollow metal steel composite type fire doors rated up to and including 3 hrs Wood composite type fire doors rated up to and including 1½ hrs and 20 minutes without hose stream

No.	Fastener	Size	Weight
PDLAA	#12 x 1-1/4" FH SMS	1½" x 2³/₁₆"	0.8 oz.



Door Silencer No. 608CA

Material: Clear rubber

Other: Sold in packages of 300

Features: Self-adhesive mounting

No.	Fastener	Size	Weight
608CA	³/₈" dia. x 1/₈"	Metal or wood	0.2 lbs./300

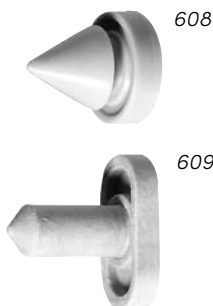

Door Silencers No. 608-RKW, 609

Material: Gray rubber

Other: Sold in packages of 100

No.	Size	Frame Type	Weight
608-RKW	½" dia. x ⁵/₈"	Metal	1.3 lbs./500
609	³/₈" x ¾"	Wood	1.3 lbs./500

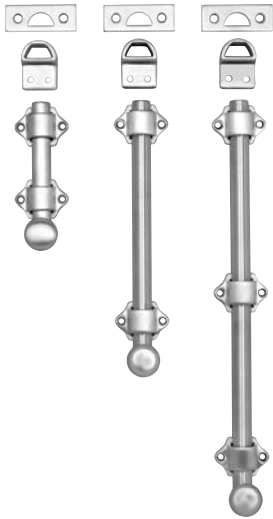

Surface Bolts No. 630 Series

Material: Solid brass

Finishes: US3, US10B, US26D, other finishes available on special order

Features:

- Unique fiber gasket provides slide resistance without marring surface of bolt
- 1" diameter knob
- Supplied with universal and mortise strike

No.	Fastener	Overall Size	Bolt Size	Bolt Length	Bolt Throw	Guides	Weight
630-4	8 ea. #6x ³ / ₄ " OH SMS	1 ⁵ / ₈ " x 4 ³ / ₈ "	⁵ / ₈ " half round	4"	⁹ / ₁₆ "	2	2.5 lbs./5
630-8	8 ea. #6x ³ / ₄ " OH SMS	1 ⁵ / ₈ " x 8"	⁵ / ₈ " half round	8"	⁹ / ₁₆ "	2	3.9 lbs./5
630-12	10 ea. #6x ³ / ₄ " OH SMS	1 ⁵ / ₈ " x 12"	⁵ / ₈ " half round	12"	⁹ / ₁₆ "	3	5.3 lbs./5
630-24	12 ea. #6x ³ / ₄ " OH SMS	1 ⁵ / ₈ " x 24"	⁵ / ₈ " half round	24"	⁹ / ₁₆ "	4	11.8 lbs./5

ROCKWOOD®

ASSA ABLOY

Experience a safer
and more open world

800 458 2424 | www.rockwoodmfg.com
Check the web site for the up-to-date catalog

Copyright © 2012-2024, ASSA ABLOY Accessories and Door Controls Group, Inc. All rights reserved. Reproduction in whole or in part without the express written permission of ASSA ABLOY Accessories and Door Controls Group, Inc. is prohibited.

Door Coordinators No. 2600 Series

Material: Steel

Finishes: Black, US28

Fastener: 7 ea. #12 - 24 x 1 1/4 TH type C tapping screws

Size: Standard device size 5/8" x 1 5/8" x 52"

Features: Non-handed. Override protection to prevent damage in case of abnormal force on door Mechanism and filler bar completely fill width of opening and when painted to match frame it becomes virtually invisible

Ordering: Stock Sizes

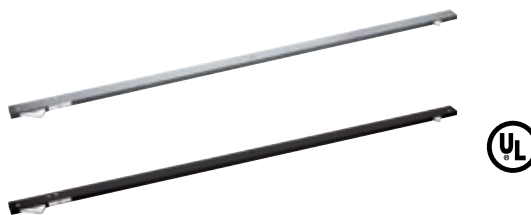

No.	Opening	Weight
2660	60"	7.0 lbs.
2672	72"	8.0 lbs.
2696	96"	9.75 lbs.

Custom Sizes – The 2600 Series coordinators are manufactured in different housing lengths to coordinate the full range of door sizes:

- NX2600 Series: For jamb opening widths (A + B dimension) from 48" - 54". E dimension, 42"
- 2600 Series: For jamb opening widths (A + B dimension) from 54" - 96". E dimension, 52"

Determining Coordinator Item Number

- Active door widths A plus inactive door width B equals the last two or three digits of all 2600 Series coordinator item numbers (2680 is for 80" door opening)
- Less than 48" jamb widths = N2600 Series (N2644 = 44" opening).
- Larger sizes are available (L, XL). Contact the factory

NOTE: 2600 Series Coordinators are designed so that surface vertical rod strike preps can be made directly into the coordinator body.

No.	Jamb Widths	Coordinator Length
NX2648- NX2654	48" - 54"	42"
2655 - 2660	55" - 60"	52"
2661 - 2672	61" - 72"	52"
2673 - 2696	73" - 96"	52"

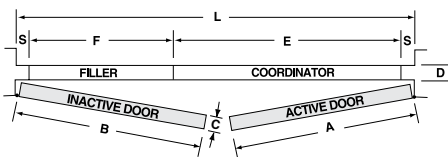

Fillers are usually supplied precut from the factory (filler bars shown on page E14).

NOTE: If "S" dimension is other than 5/8" advise the factory.

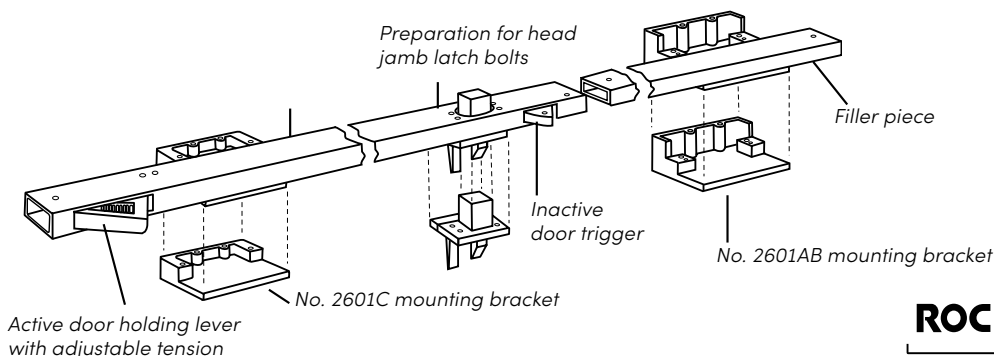

800 458 2424 | www.rockwoodmfg.com
Check the web site for the up-to-date catalog

Copyright © 2012-2024, ASSA ABLOY Accessories and Door Controls Group, Inc. All rights reserved. Reproduction in whole or in part without the express written permission of ASSA ABLOY Accessories and Door Controls Group, Inc. is prohibited.

ROCKWOOD®
ASSA ABLOY

Experience a safer
and more open world



Carry Bar for No. 1600 /2600 Series Coordinator No. 1100

Material: Brass, steel

Finishes: US32D, and black prime coat

Fastener: 2 ea. 12-24 x $\frac{3}{4}$ " round head machine screws
2 ea. 12-24 x $\frac{1}{16}$ " sex bolts

Other: A carry bar is used when it is possible to open the inactive door before opening the active door

No.	Size	Weight
1100	1 $\frac{3}{4}$ " x 2 $\frac{1}{4}$ "	0.3 lbs.



Filler Bar for No. 1600 /2600 Series Coordinator No. FB-1, FB-2

Material: Steel

Finishes: Black, US28

Features: Filler bar is supplied at no charge with the No. 1600 and 2600 Series coordinator (shown on pages E12 & E13)

No.	Size
FB-1	Specify length from 1 $\frac{5}{8}$ " to 18 $\frac{5}{8}$ "
FB-2	Specify length from 19 $\frac{5}{8}$ " to 42 $\frac{5}{8}$ "

Contact factory for larger sizes.



2601AB



2601C

Mounting Brackets (for Soffit Applied Hardware) No. 2601AB, 2601C

Material: Aluminum

Finishes: Black, US28

Fastener: 4 ea. $\frac{1}{4}$ -20 x $\frac{1}{2}$ " FH MS, 4 ea. #12-24 x 2" FH MS.

Features: Used for stop applied hardware. Prevents the inadvertent disabling of the coordinator by fasteners passing through the housing

No.	Soffit Size	Length	Weight
2601AB	$\frac{7}{8}$ " - 2 $\frac{1}{4}$ "	5"	0.9 lbs.
2601C	Over 2 $\frac{1}{4}$ "	5"	0.8 lbs.

ROCKWOOD®

ASSA ABLOY

Experience a safer
and more open world

800 458 2424 | www.rockwoodmfg.com
Check the web site for the up-to-date catalog

Copyright © 2012-2024, ASSA ABLOY Accessories and Door Controls Group, Inc. All rights reserved. Reproduction in whole or in part without the express written permission of ASSA ABLOY Accessories and Door Controls Group, Inc. is prohibited.



Mounting Brackets (for Soffit Applied Hardware) No. 2601D

Material: Aluminum

Finishes: Black, US28

Fastener: 4 ea. 1/4"-20 x 1/2" Flat Head Machine Screws
2 ea. #12-24 x 2" Flat Head Machine Screws

Features: Fits all frame dimensions eliminating the need to order different style mounting brackets. The low profile design enhances the appearance of the opening.

Patent No. 9109388

No.	Length	Width	Weight
2601D	7 13/16"	1 13/16"	.6 lbs.



Universal Door Coordinator No. 1700

Material: Steel



Finishes: Black prime coat, US28

Fastener: 4 ea. 10-24 x 2" flat head machine screws and #10 x 2" sheet metal screws

Features: For pairs of doors. Non-handed. Stop mounted - no mounting brackets required for stop mounted hardware.

NOTE: Not for use with surface vertical panic devices.

No.	Overall Size	Weight
1700	1 5/8" x 20 3/16" x 3/4"	2.55 lbs.



Automatic Flush Bolts No. 2840 (Automatic Top Bolt Only) No. 2842 (Set) (replaces the No. 1840 and No. 1842)

Material: Brass, stainless steel

Finishes: US3, US4, US10, US10B, 10BE, US26, US26D, US32D

Fastener: No. 2842: 20 ea. #8 x 3/4" FH combo screws, 2 ea. #6-8 plastic anchors
No. 2840: 10 ea. #8 x 3/4" FH combo screws. NOTE: No plastic anchor required for top only

Features:

- For Fire Rated Metal Doors labeled A, B, C, D & E up to 4'w x 8'h
- Non-handed
- Fully automatic— opening active door retracts top and bottom bolts
- Override feature prevents damage to doors or bolts if bolt heads are blocked from entering strikes
- Bolt head rods are adjustable up to 1 1/2"
- Thermal lock automatically locks the inactive door under high heat conditions due to fire

Options: No. 2842 can be used with the No. 570 Dust Proof Strike (shown on page E4).

No.	Size	Weight
2840	1" x 6 3/4"	1.2 lbs.
2842	1" x 6 3/4"	2.4 lbs.



Combination Flush Bolts No. 2805 (Self Latching Top Bolt Only) No. 2845 (Set) (replaces No. 1805 and No. 1845)

Material: Brass, stainless steel

Finishes: US3, US4, US10, 10BE, US26D, US32D, US32, BSP

Fastener: Top: 2 ea. #8 x 1" Flat Head Combo Screws; 6 ea. #8 x 1" Flat Head Machine Screws.
NOTE: No plastic anchor required for top only.
Bottom (No. 2845 only) 4 ea. #8 x 1" Flat Head Combo Screws; 14 ea. #8 x 1" Flat Head Machine Screws, 2 ea. #6-8 plastic anchors.

Features:

- For Fire Rated Metal Doors labeled A, B, C, D & E up to 4'w x 8'h

Top Bolt

- Automatically engages when the inactive door closes. When the active door is opened, the inactive door stays latched at the top until the top bolt is released by pressing the plunger button on the bolt face

Bottom Bolt (No. 2845 only)

- Non-handed
- Fully automatic — opening active door retracts bottom bolt
- Override feature prevents damage to door or bolt if bolt head is blocked from entering strike
- Bolt head rod is adjustable up to 3/4"
- Thermal lock automatically locks the inactive door under high heat conditions due to fire

Options: No. 2845 can be used with the No. 570 Dust Proof Strike (shown on page E4)

No.	Size	Weight
2805	1" x 6 3/4"	1.2 lbs.
2845	1" x 6 3/4"	2.4 lbs.

ROCKWOOD

ASSA ABLOY

Experience a safer
and more open world

800 458 2424 | www.rockwoodmfg.com
Check the web site for the up-to-date catalog

Copyright © 2012-2024, ASSA ABLOY Accessories and Door Controls Group, Inc. All rights reserved. Reproduction in whole or in part without the express written permission of ASSA ABLOY Accessories and Door Controls Group, Inc. is prohibited.



Automatic Flush Bolt No. 2940 (Automatic Top Bolt Only) No. 2942 (Set) (replaces No. 1940 and No. 1942)

Material: Brass, stainless steel

Finishes: US3, US4, US10B, 10BE, US26, US26D, US32D, Stock Powder Coats

Fastener: No. 2940: 6 ea. #8 x 3/4" FH combo screws, 2 ea. #8 - 32 x 1/2" FH MS, 3 ea. #10 x 1" FH WS
NOTE: No plastic anchor required for top only.
No. 2942: 12 ea. #8 x 3/4" FH combo screws, 4 ea. #8 - 32 x 1/2" FH MS, 6 ea. #10 x 1" FH WS, 2 ea. #6 - 8 plastic anchors

Features:

- For Wood Doors labeled B, C, D & E up to 4'w x 8'h
- Non-handed
- Fully automatic—opening active door retracts top and bottom bolts
- Override feature prevents damage to doors or bolts if bolt heads are blocked from entering strikes
- Bolt head rods are adjustable up to 3/8"
- Thermal lock automatically locks the inactive door under high heat conditions due to fire

Options: No. 2942 can be used with the No. 570 Dust Proof Strike (shown on page E4).

No.	Size	Weight
2940	1" x 8 1/2"	1.5 lbs.
2942	1" x 8 1/2"	2.9 lbs.



Combination Flush Bolts No. 2905 (Self Latching Top Bolt Only) No. 2945 (Set) (replaces No. 1905 and No. 1945)

Material: Brass, stainless steel

Finishes: US3, US4, US10, 10BE, US26D, US32D, US32, BSP

Fastener: Top: 4 ea. #8 x 3/4" FH combo screws, 2 ea. #8 - 32 x 1/2" FH MS, 3 ea. #10 x 1" FH WS.
NOTE: No plastic anchor required for top only.
Bottom (No. 2945 only): 10 ea. #8 x 3/4" FH combo screws, 4 ea. #8 - 32 x 1/2" FH MS, 6 ea. #10 x 1" FH WS, 2 ea. #6 - 8 plastic anchors

Features:

- For Wood Doors labeled B, C, D & E up to 4'w x 8'h

Top Bolt

- Automatically engages when the inactive door closes. When the active door is opened, the inactive door stays latched at the top until the top bolt is released by pressing the plunger button on the bolt face

Bottom Bolt (No. 2945 only)

- Non-handed
- Fully automatic — opening active door retracts bottom bolt
- Override feature prevents damage to door or bolt if bolt head is blocked from entering strike
- Bolt head rod is adjustable up to 3/8"
- Thermal lock automatically locks the inactive door under high heat conditions due to fire

Options: No. 2945 can be used with the No. 570 Dust Proof Strike (shown on page E4).

No.	Size	Weight
2905	1" x 8 1/2"	1.5 lbs.
2945	1" x 8 1/2"	2.9 lbs.





Automatic Flush Bolt with Bottom Fire Bolt No. 2848 (replaces 1848)

- Material:** Brass, stainless steel
- Finishes:** US3, US4, US10, 10BE, US32D, US32, BSP
- Fastener:** 10 ea. #8x³/₄" FH combo screws, 4 ea. plastic anchors
- Features:**
- For Fire Rated Metal Doors
 - Low (5 lbs. maximum) closing force
 - Fully automatic—opening active door retracts top bolt
 - Override feature prevents damage to doors or bolt if bolt head is blocked from entering strike
 - Bolt head rod is adjustable up to 1¹/₂"
 - For fire rated metal doors labeled A, B, C, D, & E up to 4'wx9'h
 - Thermal lock automatically locks the inactive door under high heat conditions due to fire
 - Bottom fire bolt eliminates need for floor prep
 - Oversize fire bolt strike hole allows for slight door misalignment

No.	Size	Weight
2848	Top bolt: 1" x 6 ³ / ₄ " Bottom bolt: ¹³ / ₁₆ " dia.	1.3 lbs.



Automatic Flush Bolt with Bottom Fire Bolt No. 2948 (replaces 1948)

- Material:** Brass, stainless steel
- Finishes:** US3, US4, US10, 10BE, US32D, US32, BSP
- Fastener:** 8 ea. #8x³/₄" FH combo screws, 2 ea. plastic anchors;
3 ea. #10x1" FH WS
- Features:**
- For Fire Rated Wood Doors
 - Low (5 lbs. maximum) closing force
 - Fully automatic—opening active door retracts top bolt
 - Override feature prevents damage to doors or bolt if bolt head is blocked from entering strike
 - Bolt head rod is adjustable up to 1¹/₂"
 - For fire rated UL listed 20-minute wood core and composite doors up to 4'wx9'h
 - Thermal lock automatically locks the inactive door under high heat conditions due to fire
 - Bottom fire bolt eliminates need for floor prep
 - Oversize fire bolt strike hole allows for slight door misalignment

No.	Size	Weight
2948	Top bolt: 1" x 8 ¹ / ₂ " Bottom bolt: ¹³ / ₁₆ " dia.	1.6 lbs.

ROCKWOOD[®]

ASSA ABLOY

Experience a safer
and more open world

800 458 2424 | www.rockwoodmfg.com
Check the web site for the up-to-date catalog

Copyright © 2012–2024, ASSA ABLOY Accessories and Door Controls Group, Inc. All rights reserved. Reproduction in whole or in part without the express written permission of ASSA ABLOY Accessories and Door Controls Group, Inc. is prohibited.



Bottom Fire Bolt (for Metal Doors) No. 18BFB

Material: Stainless steel

Finishes: US32D

Features:

- Eliminates the bottom automatic flush bolt and dust proof strike
- When door is subjected to 230°F the plug and gray plastic cover will melt allowing the bolt to project, locking the leaves together
- UL Listed only when used with automatic top bolt

No.	Size	Weight
18BFB	Bolt: $1\frac{3}{16}$ " x $1\frac{9}{16}$ " Plug: $1\frac{7}{32}$ " dia.	0.1 lbs.



Cover Plate Kit (for Metal Doors) No. CPK2840

Material: Brass, Stainless Steel

Finishes: US3, US4, US10, US10B, 10BE, US32D, US32

Fastener: 4 ea. #8 x $\frac{3}{4}$ " FH combo screws

Features: Covers existing bottom 2840 flush bolt prep

No.	Size	Weight
CPK2840	1" x $6\frac{3}{4}$ "	0.1 lbs.



Bottom Fire Bolt (for Wood Doors) No. 19BFB

Material: Stainless steel

Finishes: US32D

Features:

- Eliminates the bottom automatic flush bolt and dust proof strike
- When door is subjected to 230°F the plug and black plastic cover will melt allowing the bolt to project, locking the leaves together
- UL Listed only when used with automatic top bolt

No.	Size	Weight
19BFB	Bolt: $1\frac{3}{16}$ " x $1\frac{9}{16}$ " Plug: $1\frac{13}{64}$ " dia.	0.1 lbs.



Automatic Flush Bolt with Bottom Fire Bolt No. 2960 (replaces 1960)

Material: Brass, Stainless Steel

Finishes: US3, US4, US10, 10BE, US32D, US32, BSP

Fastener: 4 ea. #8x1" FH SMS, 4 ea. #8x³/₄" FH combo screws, 2 ea. plastic anchors

- Features:**
- For Fire Rated Wood Core & Composite Doors
 - Durable, tested over 1 million cycles
 - Smaller profile adds stability to the door
 - Only two 1¹/₈" diameter holes for easier door preparation
 - Preparation prevents the veneer from splitting at the corners of the door
 - Quiet & smooth activation
 - Fully automatic—opening active door retracts top bolt
 - Non-handed.
 - Override feature prevents damage to doors or bolt if bolt head is blocked from entering strike
 - Low (3 lbs. maximum) closing force. ADA Compliant
 - Adjustable bolt head rod: bolts can be vertically adjusted 1¹/₂" for unusual clearances
 - For up to 4'w x 9'h fire rated wood core & composite doors up to 20 minutes fire rating.

No.	Face Plate Size	Weight
2960	1 ¹ / ₈ " x 2 ¹ / ₄ "	0.9 lbs.

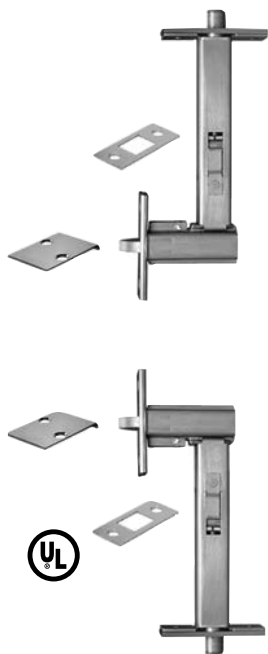

Automatic Flush Bolts No. 2962 (replaces 1962)

Material: Brass, stainless steel

Finishes: US3, US4, US10, 10BE, US32D, US32, BSP

Fastener: 8 ea. #8x1" FH SMS, 8 ea. #8x³/₄" FH combo screws, 4 ea. plastic anchors

- Features:**
- For Fire Rated Wood Core & Composite Doors
 - Durable, tested over 1 million cycles
 - Smaller profile adds stability to the door
 - Only two 1¹/₈" diameter holes for easier door preparation
 - Preparation prevents the veneer from splitting at the corners of the door
 - Quiet & smooth activation
 - Fully automatic—opening active door retracts top & bottom bolts.
 - Non-handed
 - Override feature prevents damage to doors or bolt if bolt head is blocked from entering strike
 - Low (3 lbs. maximum) closing force. ADA Compliant
 - Adjustable bolt head rods: bolts can be vertically adjusted 1¹/₂" for unusual clearances
 - For up to 4'w x 9'h fire rated wood core & composite doors up to 1¹/₂ hours fire rating

No.	Face Plate Size	Weight
2962	1 ¹ / ₈ " x 2 ¹ / ₄ "	1.7 lbs.

ROCKWOOD[®]

ASSA ABLOY

Experience a safer
and more open world

800 458 2424 | www.rockwoodmfg.com
Check the web site for the up-to-date catalog

Copyright © 2012-2024, ASSA ABLOY Accessories and Door Controls Group, Inc. All rights reserved. Reproduction in whole or in part without the express written permission of ASSA ABLOY Accessories and Door Controls Group, Inc. is prohibited.



Self Latching Flush Bolt with Bottom Fire Bolt No. 2849 (replaces 1849)

Material: Brass, stainless steel

Finishes: US3, US4, US10, 10BE, US32D, US32, BSP

Fastener: 8 ea. #8 x 3/4" FH combo screws, 4 ea. plastic anchors

- Features:**
- For Fire Rated Metal Doors
 - Non-handed.
 - Low (5 lbs. maximum) closing force
 - Self latching top bolt
 - Override feature prevents damage to doors or bolt if bolt head is blocked from entering strike
 - Bolt head rod is adjustable up to 1/2"
 - For fire rated metal doors labeled A, B, C, D, & E up to 4'w x 10' h
 - Thermal lock automatically locks the inactive door under high heat conditions due to fire
 - Bottom fire bolt eliminates need for floor prep
 - Oversize fire bolt strike hole allows for slight door misalignment

No.	Size	Weight
2849	Top bolt: 1" x 6 3/4" Bottom bolt: 13/16" dia.	1.3 lbs.



Self Latching Flush Bolt with Bottom Fire Bolt No. 2949 (replaces 1949)

Material: Brass, stainless steel

Finishes: US3, US4, US10, 10BE, US32D, US32, BSP

Fastener: 6 ea. #8 x 3/4" FH combo screws, 2 ea. plastic anchors,
3 ea. #10 x 1" FH WS

- Features:**
- For Fire Rated Wood Doors
 - Non-handed
 - Low (5 lbs. maximum) closing force
 - Self latching top bolt
 - Override feature prevents damage to doors or bolt if bolt head is blocked from entering strike
 - Bolt head rod is adjustable up to 1/2"
 - For fire rated UL listed 20-minute wood core and composite doors up to 4'w x 9'h
 - Thermal lock automatically locks the inactive door under high heat conditions due to fire
 - Bottom fire bolt eliminates need for floor prep
 - Oversize fire bolt strike hole allows for slight door misalignment

No.	Size	Weight
2949	Top bolt: 1" x 8 1/2" Bottom bolt: 13/16" dia.	1.6 lbs.

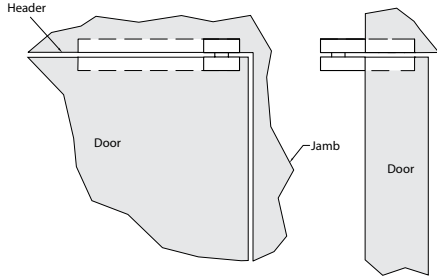
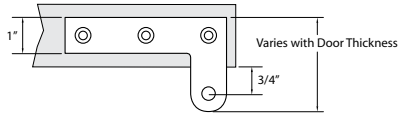

Standard Head Pivot No. CP10, CP10HD

- Material:** Solid brass leaf, Stainless steel pin
- Finishes:** US3, US4, US10, US10B, US26, US26D, other finishes available on request
- Fastener:** 6 ea. #12x1 1/4" FH wood screws
- Ordering:** Specify door thickness
- Features:**
- Mostly invisible when installed
 - Includes Teflon® bearing for smooth silent operation
 - Field changeable handing
 - Standard duty is made from 3/8" thick brass
 - Heavy duty (HD) is made from 1/2" thick brass

No.	Weight
CP10	1.3 lbs.
CP10HD	1.9 lbs.

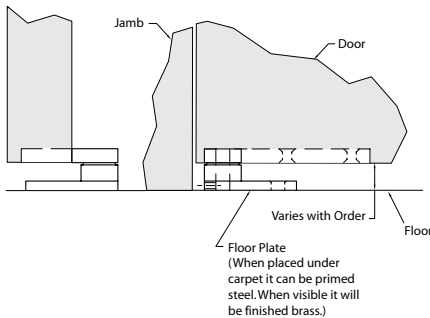
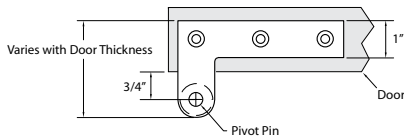

Standard Floor Pivot No. CP40, CP40HD

- Material:** Solid brass leaf, Stainless steel pin
- Finishes:** US3, US4, US10, US10B, US26, US26D, other finishes available on request
- Fastener:** 6 ea. #12x1 1/4" FH wood screws
- Ordering:** Specify door thickness and floor clearing
- Features:**
- Mostly invisible when installed
 - Includes Teflon® bearing for smooth silent operation
 - Field changeable handing
 - Standard duty is made from 3/8" thick brass
 - Heavy duty (HD) is made from 1/2" thick brass

No.	Weight
CP40	1.3 lbs.
CP40HD	1.9 lbs.

ROCKWOOD®

ASSA ABLOY

Experience a safer
and more open world

800 458 2424 | www.rockwoodmfg.com
Check the web site for the up-to-date catalog

Copyright © 2012-2024, ASSA ABLOY Accessories and Door Controls Group, Inc. All rights reserved. Reproduction in whole or in part without the express written permission of ASSA ABLOY Accessories and Door Controls Group, Inc. is prohibited.



Door Knocker No. 611

- Material:** Solid cast brass
- Finishes:** Available in standard architectural finishes (see page 9)
- Fastener:** 2 ea. #8 - 32x2" FH MS (for standard 1³/₄" doors); 2 ea. #8 finish washers
- Options:**
- Drill for door viewer No. 621 (order viewer separately)
 - Engrave numbers or name. Assorted fonts are available

No.	Size	Weight
611	3 ⁵ / ₈ " x 6 ³ / ₄ "	0.6 lbs.



No. 614

No. 614V

Door Knockers No. 614, 614V

- Material:** Cast brass
- Finishes:** Available in standard architectural finishes (see page 9)
- Fastener:** 2 ea. #8 - 32x2" FH MS (for standard 1³/₄" doors); 2 ea. #8 finish washers
- Features:** No. 614V includes door viewer No. 622
- Options:** Engrave numbers or name

No.	Size	Weight
614	2 ¹ / ₈ " x 3"	0.4 lbs.
614V	2 ¹ / ₈ " x 3"	0.4 lbs.



No. 619

No. 620/621



No. 624

160° Door Viewers No. 619, 620, 620VC, 621, 624

- Material:** Brass
- Finishes:** Antique bronze (ANT), brass (BRS), bright chrome (CRM), satin nickel (*STNN)
*only available on 619, 620
- Other:** Installation - drill 1/2" hole
- Features:** No. 624 features a privacy cover to prevent visual intrusion from outside of the room

No.	Inside Cover	For Doors	Weight
619	No	1 ¹ / ₁₆ " to 1 ¹ / ₁₆ "	0.05 lbs.
620	No	1 ³ / ₈ " to 2"	0.1 lbs.
620VC	Cover only		0.1 lbs./10
621	No	2" to 2 ¹ / ₂ "	0.1 lbs.
624	Yes	1 ³ / ₈ " to 2"	0.1 lbs.

Recommended Location for Viewers

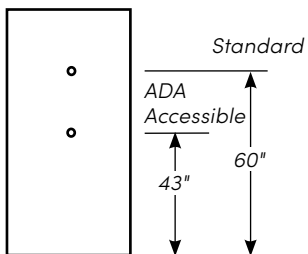

800 458 2424 | www.rockwoodmfg.com
Check the web site for the up-to-date catalog

Copyright © 2012-2024, ASSA ABLOY Accessories and Door Controls Group, Inc. All rights reserved. Reproduction in whole or in part without the express written permission of ASSA ABLOY Accessories and Door Controls Group, Inc. is prohibited.

ROCKWOOD®
ASSA ABLOY

Experience a safer
and more open world



No. 626



No. 622

190° Door Viewer No. 622, 622VC, 626

Material: Brass

Finishes: Antique bronze (ANT), brass (BRS), bright chrome (CRM), dull chrome (DCRM), satin nickel *(STNN)
*only available on 622

Other: Installation – drill $\frac{9}{16}$ " hole

Features: No. 626 features a privacy cover to prevent visual intrusion from outside of the room

No.	Inside Cover	For Doors	Weight
622	No	$1\frac{3}{8}$ " to $2\frac{1}{8}$ "	0.1 lbs.
622VC	Cover only		0.1 lbs./10
626	Yes	$1\frac{3}{8}$ " to $2\frac{1}{8}$ "	0.1 lbs.



No. 627, 628, 629

190° Door Viewer with Heavy Duty Privacy Cover No. 627, 628, 629

Material: Brass

Finishes: Bright chrome (CRM), Black (BLK)

Other: Installation – drill $\frac{9}{16}$ " hole. UL fire rated for $1\frac{1}{2}$ hours

Features: Heavy duty privacy cover to prevent visual intrusion from outside of the room

No.	For Doors	Weight
627	$1\frac{3}{8}$ " to $2\frac{1}{4}$ "	0.1 lbs.
628	$\frac{9}{16}$ " to $\frac{13}{16}$ "	0.1 lbs.
629	$\frac{15}{16}$ " to $1\frac{1}{4}$ "	0.1 lbs.

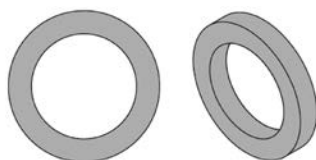

Door Viewer Washer No. 618W

Material: Brass

Finishes: Polished brass (BRS), bright chrome (CRM), satin nickel (STNN), antique bronze (ANT)

Other: Designed for use when the door is not thick enough to meet the specifications of the viewer. Can be used with all Rockwood Door Viewers.

No.	For Doors	Dimensions
618W	$\frac{9}{16}$ " to $2\frac{1}{2}$ "	$\frac{1}{8}$ " width, $\frac{9}{16}$ " inner dia, $\frac{13}{16}$ " outer dia



Card Holder No. 651

Material: Cast brass

Finishes: Available in standard architectural finishes (see page 9)

Fastener: 2 ea. #8 x $\frac{3}{4}$ " OH SMS

No.	Size	Card Size	Opening	Weight
651	$2\frac{1}{2}$ " x $4\frac{1}{4}$ "	2" x $3\frac{1}{2}$ "	$1\frac{3}{4}$ " x $3\frac{1}{4}$ "	0.2 lbs.

ROCKWOOD

ASSA ABLOY

Experience a safer
and more open world

800 458 2424 | www.rockwoodmfg.com

Check the web site for the up-to-date catalog

Copyright © 2012–2024, ASSA ABLOY Accessories and Door Controls Group, Inc. All rights reserved. Reproduction in whole or in part without the express written permission of ASSA ABLOY Accessories and Door Controls Group, Inc. is prohibited.

THIS DOOR TO REMAIN UNLOCKED DURING BUSINESS HOURS

No. 660

THIS DOOR TO REMAIN UNLOCKED WHILE BUILDING IS OCCUPIED

No. 661

THESE DOORS TO REMAIN UNLOCKED WHILE BUILDING IS OCCUPIED

No. 662-RKW

Decal No. 660, 661, 662-RKW

- Material:** Silver foil
- Fastener:** Self-adhesive mounting
- Other:** Black lettering
- Size:** 1½" x 26½"



Engraved Signs No. 670 Series

- Material:** .125" plastic or .050" aluminum, brass, bronze, stainless steel
- Finishes:** Plastic signs: available in black or brown with white lettering
Metal signs: available in standard architectural finishes (see page 9)
- Fastener:** 2 ea. #6 x 5/8" OH SMS
- Ordering:** Specify product number, finish, and copy
- Features:**
 - Standard letter size is 1" high by 1/8" wide stroke. Other sizes from 1/2" to 3" are available
 - Standard font is US Block, other fonts available
 - Sign size is determined by the height and length of the engraving and is calculated to allow for an appropriate border
- Options:**
 - SA – self-adhesive mounting
 - Custom sizes and messages

No.	Message	Size
670	Specify copy	2" x width required
670M	MEN	2" x 5"
670W	WOMEN	2" x 7"
670R	RESTROOM	2" x 10"



No. 674L



No. 674H

Engraved Signs No. 674H, 674L

- Material:** .125" plastic or .050" aluminum, brass
- Finishes:** Plastic signs: available in black or brown with white lettering
Metal signs: available in standard architectural finishes (see page 9)
- Fastener:** Self-adhesive mounting
- Size:** 1" x 4½"

ROCKWOOD®

ASSA ABLOY

Experience a safer
and more open world

800 458 2424 | www.rockwoodmfg.com
Check the web site for the up-to-date catalog

Copyright © 2012-2024, ASSA ABLOY Accessories and Door Controls Group, Inc. All rights reserved. Reproduction in whole or in part without the express written permission of ASSA ABLOY Accessories and Door Controls Group, Inc. is prohibited.

. MEN .

. WOMEN .

. RESTROOM .

. ADMINISTRATION .

Barrier Free Engraved Signs (with Braille Translation) No. BF680 Series

Material: .125" non-glare plastic or .050" brass, bronze

Finishes: Plastic signs: available in black, blue, brown, or red with white lettering
Metal signs: available in standard architectural finishes (see page 9).

Fastener: 2 ea. #6x⁵/₈" OH SMS

Ordering: Specify product number, finish, and copy

Features:

- Plastic signs meet ANSI A117.1-1998 section 703 requirements.
- 1" letter height is standard; other sizes available from ⁵/₈" to 2"
- Meets width to height ratio requirements
- Sign size is determined by the height and length of the engraving and is calculated to allow for an appropriate border
- Grade 2 braille translation on sign
- Screws provided for secure mounting
- Made to order, any copy available
- Plastic signs have easy to read letters and numbers that are raised ¹/₃₂" from sign surface
- Plastic signs characters and background have a non-glare finish of contrasting light on dark color
- Metal signs have easy to read raised black lettering

Options:

- SA – self-adhesive mounting
- Custom sizes and messages

No.	Message	Size
BF680	Specify copy	2 ¹ / ₂ " x width required
BF680M	MEN	2 ¹ / ₂ " x 5"
BF680W	WOMEN	2 ¹ / ₂ " x 7"
BF680R	RESTROOM	2 ¹ / ₂ " x 9"

ROCKWOOD®

ASSA ABLOY

Experience a safer
and more open world

800 458 2424 | www.rockwoodmfg.com
Check the web site for the up-to-date catalog

Copyright © 2012-2024, ASSA ABLOY Accessories and Door Controls Group, Inc. All rights reserved. Reproduction in whole or in part without the express written permission of ASSA ABLOY Accessories and Door Controls Group, Inc. is prohibited.

BF Series ADA Signs

- Material:** .125" non-glare plastic or .050" brass, bronze
- Finishes:** Plastic signs: available in black, blue, brown, or red with standard 1" white lettering
Metal signs: available in standard architectural finishes (see page 9)
- Fastener:** 4 ea. #6 x 5/8" OH SMS
- Size:** 8" x 8"
- Ordering:** Specify background finish along with any options
- Features:** **Plastic signs:**
- Raised characters and Grade 2 Braille translation
 - Meets ADAAG Section 4.30 requirements
- Metal signs:**
- Raised black lettering and Grade 2 Braille translation.
 - Attractive architectural finishes
- Options:**
- SA – self-adhesive mounting

No. BF683



No. BF684



No. BF685



No. BF686



No. BF687



No. BF688



No. BF689



Recommended Mounting Location for Signs

Excerpts from ADA Accessibility Guidelines for Buildings and Facilities (ADAAG).

4.30.6 Mounting Location and Height: Where permanent identification is provided for rooms and spaces, signs shall be installed on the wall adjacent to the latch side of the door. Where there is no wall space to the latch side of the door, including at double leaf doors, signs shall be placed on the nearest adjacent wall. Mounting height shall be 60" (1525 mm) above the finish floor to the centerline of the sign. Mounting location for such signage shall be so that a person may approach within 3" (76 mm) of signage without encountering protruding objects or standing within the swing of a door.

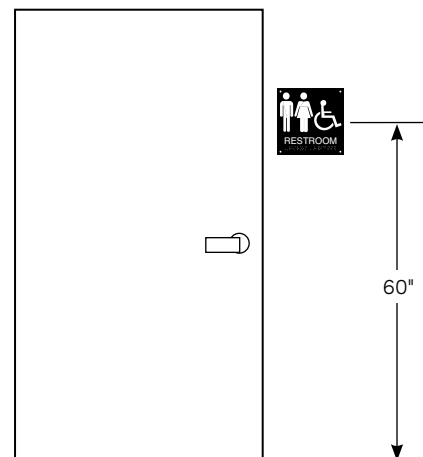

ROCKWOOD®
ASSA ABLOY

Experience a safer
and more open world

BFM Series ADA Molded Plastic Signs

- Material:** Molded plastic
- Colors:** 5/8" white lettering on choice of blue or black background
- Fastener:** Self-adhesive mounting
- Size:** 6" x 9"
- Ordering:** Specify product number and background color
- Features:**
 - Raised lettering and Grade 2 Braille translation
 - Meets ADAAG Section 4.30 requirements
 - Economical molded plastic

No. BFM682



No. BFM684



No. BFM685



No. BFM686



No. BFM687



No. BFM688



No. BFM689



All Gender Restroom Signs

Economical molded plastic; 6" x 9" and 12" diameter. White lettering on Blue background. Self-adhesive mounting. BFM625 has raised lettering and Grade 2 Braille translation.



BFM624



BFM625

Recommended Mounting Location for Signs

Excerpts from ADA Accessibility Guidelines for Buildings and Facilities (ADAAG).

4.30.6 Mounting Location and Height: Where permanent identification is provided for rooms and spaces, signs shall be installed on the wall adjacent to the latch side of the door. Where there is no wall space to the latch side of the door, including at double leaf doors, signs shall be placed on the nearest adjacent wall. Mounting height shall be 60" (1525 mm) above the finish floor to the centerline of the sign. Mounting location for such signage shall be so that a person may approach within 3" (76 mm) of signage without encountering protruding objects or standing within the swing of a door.

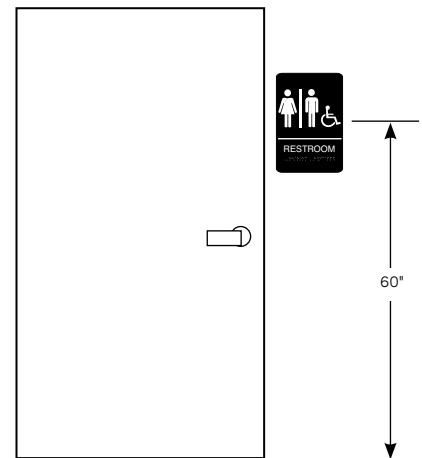

ROCKWOOD®

ASSA ABLOY

Experience a safer and more open world

800 458 2424 | www.rockwoodmfg.com
Check the web site for the up-to-date catalog

Copyright © 2012-2024, ASSA ABLOY Accessories and Door Controls Group, Inc. All rights reserved. Reproduction in whole or in part without the express written permission of ASSA ABLOY Accessories and Door Controls Group, Inc. is prohibited.



Hand Rail Brackets No. 700, 701, 702

Material: Cast brass

Finishes: Available in standard architectural finishes (see page 9)

	Fastener:	
	Wood rail	Metal rail
700	$\frac{5}{16}$ -18x1 $\frac{1}{2}$ " FH MS, anchor; 3 ea. #12-24x1" FH MS; 2 ea. #8x $\frac{3}{4}$ " OH SMS; 1 ea. back plate	$\frac{5}{16}$ -18x1 $\frac{1}{2}$ " FH MS, anchor; 3 ea. #12-24x1" FH MS; 2 ea. #8-32x $\frac{3}{4}$ " OH MS; 1 ea. back plate.
701	$\frac{5}{16}$ -18x3" FH MS, toggle; 3 ea. #12-24x1" FH MS; 2 ea. #8x $\frac{3}{4}$ " OH SMS; 1 ea. back plate.	$\frac{5}{16}$ -18x3" FH MS, toggle; 3 ea. #12-24x1" FH MS; 2 ea. #8-32x $\frac{3}{4}$ " OH MS; 1 ea. back plate.
702	3 ea. #12x2" FH WS; 2 ea. #8x $\frac{3}{4}$ " OH SMS.	3 ea. #12x2" FH WS; 2 ea. #8-32x $\frac{3}{4}$ " OH MS.

Ordering: Specify wood rail or metal rail

No.	Base	Projection (to rail centerline)	Weight
700	2 $\frac{13}{16}$ "	3 $\frac{1}{2}$ "	2.0 lbs.
701	2 $\frac{13}{16}$ "	3 $\frac{1}{2}$ "	1.8 lbs.
702	2 $\frac{13}{16}$ "	3 $\frac{1}{2}$ "	1.5 lbs.



Small Coat Hook No. 790

Material: Cast brass

Finishes: Available in standard architectural finishes (see page 9)

Fastener: 2 ea. #6x⁵/₈" OH SMS

No.	Size	Projection	Weight
790	1 ¹ / ₄ "w x 1 ³ / ₈ "h	1 ⁷ / ₈ "	.9 lbs./10



Small Double Coat Hook No. 796

Material: Cast brass

Finishes: Available in standard architectural finishes (see page 9)

Fastener: 2 ea. #6x³/₄" OH SMS

No.	Size	Projection	Weight
796	1 ¹ / ₈ "w x 1 ¹ / ₈ "h	1 ¹ / ₈ "	1 lbs./10



Medium Coat Hook No. 802

Material: Cast brass

Finishes: Available in standard architectural finishes (see page 9)

Fastener: 2 ea. #6x³/₄" RH WS

No.	Size	Projection	Weight
802	1 ³ / ₁₆ "w x 1 ¹ / ₂ "h	3"	1.1 lbs./10



Medium Coat Hook No. 806

Material: Cast brass

Finishes: Available in standard architectural finishes (see page 9)

Fastener: 2 ea. #6x³/₄" OH WS

No.	Size	Projection	Weight
806	1 ¹ / ₁₆ "w x 1 ¹ / ₄ "h	3 ¹ / ₈ "	1.4 lbs./10

ROCKWOOD[®]

ASSA ABLOY

Experience a safer
and more open world

800 458 2424 | www.rockwoodmfg.com
Check the web site for the up-to-date catalog

Copyright © 2012-2024, ASSA ABLOY Accessories and Door Controls Group, Inc. All rights reserved. Reproduction in whole or in part without the express written permission of ASSA ABLOY Accessories and Door Controls Group, Inc. is prohibited.



1½" Ball Knob No. 841

- Material:** Solid brass.
- Finishes:** US26, other finishes available upon request.
- Fastener:** #8 - 32x1" TH MS.
- Options:** Other screw lengths available upon request.

No.	Base	Projection	Weight
841	¾" dia.	1⅛"	2.5 lbs./10



Utility Pull No. 845

- Material:** Aluminum, brass.
- Finishes:** US3, US4, US10, US10B, 10BE, US26, US26D, burnished aluminum (ALM).
- Fastener:** 4 ea. #8 x ¾" OH SMS.

No.	Size	Projection	Weight
845	1⅞" x 5⅞"	1½"	1.6 lbs./10 (aluminum) 2.5 lbs./10 (brass)



Solid Wire Pull No. 850, 851, 852, 853

- Material:** Brass, stainless steel.
- Finishes:** US3, US4, US10, US10B, US26, US26D, US32D, US32DMS.
- Fastener:** #8 - 32x1" TH MS.
- Options:** Other CTC's available upon request.

No.	Size	CTC	Projection	Weight
850	⅝" dia.	2¾"	1¼"	3.4 lbs./25
851	⅝" dia.	3"	1¼"	3.8 lbs./25
852	⅝" dia.	3½"	1¼"	3.9 lbs./25
853	⅝" dia.	4"	1¼"	4.0 lbs./25



Heavy Wire Pull No. 856-RKW

- Material:** Brass, bronze, stainless steel.
- Finishes:** US3, US4, US10, US10B, US26, US26D, US32D, US32DMS.
- Fastener:** #8 - 32x1" TH MS.
- Options:** Other CTC's available upon request.

No.	Size	CTC	Projection	Weight
856-RKW	½" dia.	4"	1¾"	4.5 lbs./10



Flush Cup Pull No. 860

- Material:** Brass, stainless steel
Finishes: US10B, 10BE, US32D
Fastener: 2 ea. #4 x 5/8" OH WS
Other: See website for installation template

No.	Size	Weight
860	2 1/2" dia.	0.9 lbs./10



Wrought Flush Pull No. 870

- Material:** Brass, stainless steel
Finishes: US3, US10B, 10BE, US32D
Fastener: 2 ea. #4 x 5/8" OH WS

No.	Size	Weight
870	1 3/8" x 3 3/16"	0.5 lbs./10

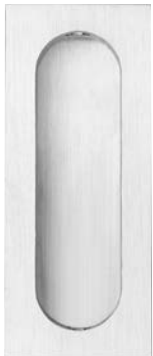

Cast Flush Pull No. 872

- Material:** Cast brass
Finishes: US3, US10B, 10BE, US32D
Fastener: 2 ea. #4 x 5/8" OH WS

No.	Size	Weight
872	1 5/16" x 3 1/8"	0.2 lbs.

ROCKWOOD®

ASSA ABLOY

Experience a safer
and more open world

800 458 2424 | www.rockwoodmfg.com
Check the web site for the up-to-date catalog

Copyright © 2012–2024, ASSA ABLOY Accessories and Door Controls Group, Inc. All rights reserved. Reproduction in whole or in part without the express written permission of ASSA ABLOY Accessories and Door Controls Group, Inc. is prohibited.



Cast Lever Edge Pull No. 880

Material: Cast brass
Finishes: US3, US10B, US26D
Fastener: 2 ea. #6x³/₄" FH SMS

No.	Size	Weight
880	³ / ₄ " x 3 ⁷ / ₈ "	0.2 lbs.



Concealed Edge Pull No. 885

Material: Brass
Finishes: Available in standard architectural finishes (see page 9)
Fastener: 2 ea. #6x1" FH WS

No.	Size	Weight
885-RKW	1" x 4 ¹ / ₄ "	0.5 lbs.



Pocket Door Pull No. 890

Material: Brass
Finishes: US3, US10B, US26, US26D
Fastener: 2 ea. #6x⁵/₈" OH SMS
Other: For use on 1³/₈" and 1³/₄" doors

No.	Size	Weight
890	2 ¹ / ₂ " w x 2 ³ / ₄ " h	0.4 lbs.

Note: Not for use in caustic environments.



Pocket Door Privacy Latch No. 891

Material: Brass
Finishes: US3, US10B, US26, US26D
Fastener: 4 ea. #6x⁵/₈" OH SMS
Other: For use on 1³/₈" and 1³/₄" doors
Features:

- Turn piece locks to jamb strike
- Emergency release on opposite side

No.	Size	Weight
891	2 ¹ / ₂ " w x 2 ³ / ₄ " h	0.4 lbs.

Note: Not for use in caustic environments.



Heavy Duty Magnetic Catch No. 900

- Material:** Aluminum
- Finishes:** Brass (BRS), natural aluminum (ALM)
- Fastener:** Body: 2 ea. #6x1 $\frac{1}{4}$ " TH SMS
Strike: 2 ea. #6x1 $\frac{1}{2}$ " FH SMS
- Features:**
- Includes installation instructions
 - Dual double-pole, self-aligning magnets
 - Packed with two short strikes and one long strike
 - Can be used on pair of doors or single door

No.	Body Size	Strike Size	Weight
900	$\frac{9}{16}$ " x 3 $\frac{1}{8}$ " x 1"	1 ea. $\frac{5}{8}$ " x 3 $\frac{1}{8}$ " 2 ea. $\frac{5}{8}$ " x 1 $\frac{1}{8}$ "	0.25 lbs.



Extra Heavy Duty Magnetic Catch No. 901

- Material:** Aluminum
- Finishes:** Brass (BRS), natural aluminum (ALM)
- Fastener:** Body: 2 ea. #6x1 $\frac{1}{2}$ " TH SMS
Strike: 2 ea. #6x1 $\frac{1}{2}$ " FH SMS
- Features:**
- Includes installation instructions
 - Dual triple-pole, self-aligning magnets
 - Packed with two short strikes and one long strike
 - Can be used on pair of doors or single door

No.	Body Size	Strike Size	Weight
901	$\frac{13}{16}$ " x 3 $\frac{1}{8}$ " x 1"	1 ea. $\frac{7}{8}$ " x 3 $\frac{1}{8}$ " 2 ea. $\frac{7}{8}$ " x 1 $\frac{1}{8}$ "	0.35 lbs.

ROCKWOOD[®]

ASSA ABLOY

Experience a safer
and more open world

800 458 2424 | www.rockwoodmfg.com
Check the web site for the up-to-date catalog

Copyright © 2012–2024, ASSA ABLOY Accessories and Door Controls Group, Inc. All rights reserved. Reproduction in whole or in part without the express written permission of ASSA ABLOY Accessories and Door Controls Group, Inc. is prohibited.



No. 910

Adjustable Ball Catch - Square Corners No. 910, 911

Material: Brass

Finishes: US26D

Fastener: 4 ea. #6 x 3/4" FH SMS

Other: No. 910: Narrow strike for mounting on door, catch in jamb
No. 911: Wide strike for mounting on jamb, catch in door

Features: Dual adjustment for door clearance and holding strength

No.	Body Size	Strike Size	Weight
910	1" x 2 1/8"	1 1/16" x 2 1/8"	0.2 lbs.
911	1" x 2 1/8"	1 3/8" x 2 1/8"	0.2 lbs.



No. 911RC

Adjustable Ball Catch - Round Corners No. 910RC, 911RC

Material: Brass

Finishes: US26D

Fastener: 4 ea. #6 x 3/4" FH SMS

Other: No. 910RC: Narrow strike for mounting on door, catch in jamb
No. 911RC: Wide strike for mounting on jamb, catch in door

Features:

- 1/4" radius corners for easy mortise installation
- Dual adjustment for door clearance and holding strength

No.	Body Size	Strike Size	Weight
910RC	1" x 2 1/8"	1 1/16" x 2 1/8"	0.2 lbs.
911RC	1" x 2 1/8"	1 3/8" x 2 1/8"	0.2 lbs.



Door Edge Filler Plate No. DF86

Material: Steel
Finishes: Prime coat
Fastener: 2 ea. #12-24 x 1/2" FH MS
Other: For gov. 86 mortise lock face

No.	Size	Weight	Pack Quantity
DF86	1 1/4" x 8" x 3/16"	11.9 lbs./25	25



Frame Hinge Filler Plate No. DFF4

Material: Steel
Finishes: Prime coat
Fastener: 2 ea. #12-24 x 1/2" FH MS
Other: For 1 3/4" rabbet frames

No.	Size	Weight	Pack Quantity
DFF4	1 5/8" x 4 1/2"	6.8 lbs./25	25



Frame Hinge Filler Plate No. DFF5

Material: Steel
Finishes: Prime coat
Fastener: 2 ea. #12-24 x 1/2" FH MS
Other: For 1 3/4" rabbet frames

No.	Size	Weight	Pack Quantity
DFF5	1 5/8" x 5"	7.9 lbs./25	25



Beveled Door Hinge Filler Plate No. DHF4B

Material: Steel
Finishes: Prime coat
Fastener: 2 ea. #12-24 x 1/2" FH MS
Other: For handed doors (beveled)

No.	Size	Weight	Pack Quantity
DHF4B	1 1/2" x 4 1/2"	6.4 lbs./25	25

ROCKWOOD®

ASSA ABLOY

Experience a safer
and more open world

800 458 2424 | www.rockwoodmfg.com
Check the web site for the up-to-date catalog

Copyright © 2012-2024, ASSA ABLOY Accessories and Door Controls Group, Inc. All rights reserved. Reproduction in whole or in part without the express written permission of ASSA ABLOY Accessories and Door Controls Group, Inc. is prohibited.



Square Door Hinge Filler Plate No. DHF4S

- Material:** Steel
Finishes: Prime coat
Fastener: 2 ea. #12-24x $\frac{1}{2}$ " FH MS
Other: For non-handed doors (square edge)

No.	Size	Weight	Pack Quantity
DHF4S	1 $\frac{3}{4}$ " x 4 $\frac{1}{2}$ "	7.7 lbs./25	25



Beveled Door Hinge Filler Plate No. DHF5B

- Material:** Steel
Finishes: Prime coat
Fastener: 2 ea. #12-24x $\frac{1}{2}$ " FH MS
Other: For handed doors (beveled)

No.	Size	Weight	Pack Quantity
DHF5B	1 $\frac{1}{2}$ " x 5"	7.2 lbs./25	25



Square Door Hinge Filler Plate No. DHF5S

- Material:** Steel
Finishes: Prime coat
Fastener: 2 ea. #12-24x $\frac{1}{2}$ " FH MS
Other: For non-handed doors (square edge)

No.	Size	Weight	Pack Quantity
DHF5S	1 $\frac{3}{4}$ " x 5"	8.5 lbs./25	25



Flush Bolt Filler Plate No. FBF48

- Material:** Steel
Finishes: Prime coat
Fastener: 2 ea. #8-32x $\frac{1}{2}$ " FH MS

No.	Size	Weight	Pack Quantity
FBF48	1" x 6 $\frac{3}{4}$ "	6.4 lbs./25	25



Flush Bolt Strike Filler Plate No. FBS48

Material: Steel
Finishes: Prime coat
Fastener: 2 ea. #8-32x $\frac{1}{2}$ " FH MS

No.	Size	Weight	Pack Quantity
FBS48	$\frac{15}{16}$ " x $2\frac{1}{4}$ "	1.3 lbs./25	25



Door Face Filler Plate No. FC161

Material: Steel
Finishes: Prime coat
Fastener: Sex bolt and sleeve
Other: To cover up to $2\frac{1}{8}$ " lock hole

No.	Size	Weight	Pack Quantity
FC161	$2\frac{5}{8}$ " dia.	4.0 lbs./25	25



Door Face Filler Plate No. FD160

Material: Steel
Finishes: Prime coat
Fastener: Sex bolt and sleeve
Other: To cover up to $1\frac{1}{2}$ " lock hole

No.	Size	Weight	Pack Quantity
FD160	$1\frac{3}{4}$ " dia.	2.0 lbs./25	25

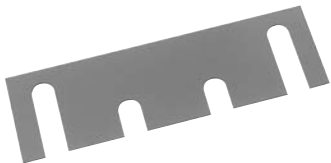

$4\frac{1}{2}$ " Hinge Shim – .028" Thick No. HS42

Material: Steel
Finishes: Galvanized coat

No.	Size	Weight	Pack Quantity
HS42	$1\frac{7}{16}$ " x $4\frac{1}{2}$ "	2.2 lbs./50	50

ROCKWOOD®

ASSA ABLOY

Experience a safer
and more open world

800 458 2424 | www.rockwoodmfg.com
Check the web site for the up-to-date catalog

Copyright © 2012-2024, ASSA ABLOY Accessories and Door Controls Group, Inc. All rights reserved. Reproduction in whole or in part without the express written permission of ASSA ABLOY Accessories and Door Controls Group, Inc. is prohibited.



4 1/2" Hinge Shim – .065" Thick No. HS44

Material: Steel

Finishes: Galvanized coat

No.	Size	Weight	Pack Quantity
HS44	1 7/16" x 4 1/2"	4.4 lbs./50	50

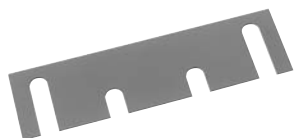

5" Hinge Shim – .028" Thick No. HS52

Material: Steel

Finishes: Galvanized coat

No.	Size	Weight	Pack Quantity
HS52	1 7/16" x 5"	2.3 lbs./50	50



5" Hinge Shim – .065" Thick No. HS54

Material: Steel

Finishes: Galvanized coat

No.	Size	Weight	Pack Quantity
HS54	1 7/16" x 5"	4.5 lbs./50	50



Latch Adapter Plate No. LA86

Material: Steel

Finishes: Prime coat

Fastener: 2 ea. #12-24 x 1/2" FH MS

Other: Change 86 cutout to 161 template

No.	Size	Weight	Pack Quantity
LA86	1 1/4" x 8"	7.5 lbs./25	25



Door Edge Filler Plate No. LF161

Material: Steel
Finishes: Prime coat
Fastener: 2 ea. #8 - 32 x 1/2" FH MS
Other: For gov. 161 latch

No.	Size	Weight	Pack Quantity
LF161	1 1/8" x 2 1/4"	2.5 lbs./25	25



Strike Filler Plate No. SF160

Material: Steel
Finishes: Prime coat
Fastener: 2 ea. #8 - 32 x 1/2" FH MS
Other: For gov. 160 latch

No.	Size	Weight	Pack Quantity
SF160	1 1/8" x 2 3/4"	2.1 lbs./25	25



Strike Filler Plate No. SFASA

Material: Steel
Finishes: Prime coat
Fastener: 2 ea. #12 - 24 x 1/2" FH MS
Other: For ASA strike

No.	Size	Weight	Pack Quantity
SFASA	1 1/4" x 4 7/8"	4.9 lbs./25	25



Strike Filler Plate No. SFB160

Material: Steel
Finishes: Prime coat
Fastener: 2 ea. #8 - 32 x 1/2" FH MS
Other: For Schlage "B" lock and other dead lock strikes

No.	Size	Weight	Pack Quantity
SFB160	1 1/8" x 2 3/4"	1.9 lbs./25	25

ROCKWOOD®

ASSA ABLOY

Experience a safer
and more open world

800 458 2424 | www.rockwoodmfg.com
Check the web site for the up-to-date catalog

Copyright © 2012-2024, ASSA ABLOY Accessories and Door Controls Group, Inc. All rights reserved. Reproduction in whole or in part without the express written permission of ASSA ABLOY Accessories and Door Controls Group, Inc. is prohibited.

The ASSA ABLOY Group is the global leader in access solutions.
Every day, we help billions of people experience a more open world.

ASSA ABLOY Opening Solutions leads the development within
door openings and products for access solutions in homes, businesses
and institutions. Our offering includes doors, frames, door and window
hardware, mechanical and smart locks, access control and service.

ROCKWOOD®

ASSA ABLOY



Rockwood Manufacturing Company
300 Main St.
Rockwood, PA 15557
www.rockwoodmfg.com
orders.rockwood@assaabloy.com
1 800 458 2424

ASSA ABLOY Opening Solutions
Door Security Solutions Canada
160 Four Valley Drive
Vaughan, ON L4K 4T9
www.assaabloydss.ca
1 800 461 3007