

DON-JO MFG., INC.

ARCHITECTURAL HARDWARE & ACCESSORIES

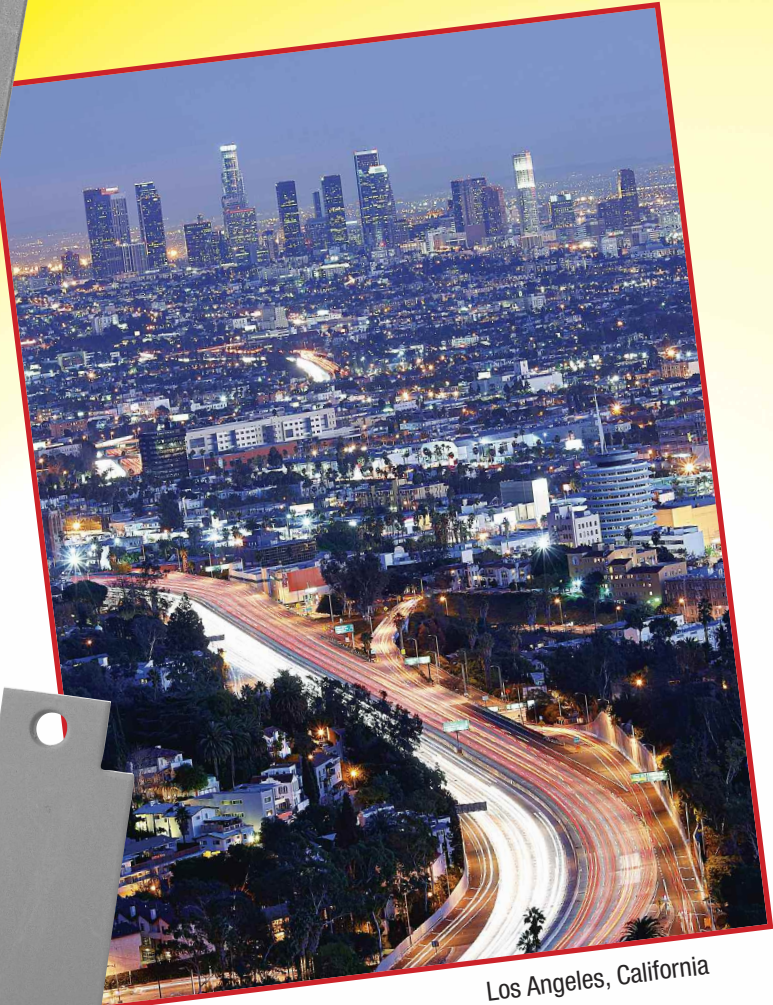

Los Angeles, California

FILLER PLATES, MOUNTING TABS & SIGNS

DON-JO MFG., INC.
P.O. Box 929
Sterling, MA 01564

PHONE: 978.422.3377
FAX: 978.422.3467
WATS: 800.628.8389
WATS FAX: 800.278.8202

WEB: www.don-jo.com
E-mail: info@don-jo.com
Section H, Version 1



INDEX

Item#	Page#	Item#	Page#	Item#	Page#	Item#	Page#
534-MWA	7h	DCB-340	5h	HR-110	4h	HS-9070-06	10h
834-ADJ	7h	DCB-350	5h	HR-120	4h	HS-9070-07	10h
AF-29	3h	DD-1	9h	HR-130	4h	HS-9070-08	10h
AF-29L	3h	DD-2	9h	HR-150	4h	HS-9070-22	10h
AF-260	3h	DD-3	9h	HR-160	4h	HS-9070-24	10h
AF-261	3h	DD-4	9h	HR-170	4h	HS-9070-27	10h
AF-291	3h	DD-5	9h	HR-180	4h	HS-9070-32	10h
AF-291L	3h	DD-6	9h	HR-190	4h	HS-9070-34	10h
AR-335	2h	DD-7	9h	HR-200-4	4h	HS-9070-35	10h
AR-9K	2h	DD-8	9h	HR-210-5	4h	HS-9070-46	9h
BF-135	2h	EF-86	1h	HR-215-4	4h	HS-9070-47	9h
BF-161	2h	EF-160	1h	HR-216-5	4h	HS-9070-48	9h
BF-178	2h	EF-161	1h	HR-217	4h	HS-9080-02	10h
BTS-160	1h	EF-161-S	1h	HR-218	4h	HS-9090-01	10h
CHS-1	9h	EF-161-TG	1h	HS-050	1h	HS-9090-05	10h
CHS-2	9h	EF-634	1h	HS-060	1h	HS-9090-32	10h
CHS-3	9h	EL-86	2h	HS-080	1h	LSP-1	3h
CHS-4	9h	EPT-1	1h	HS-090	1h	LW-86	1h
CHS-5	9h	FB-225	1h	HS-9050-01	10h	MAF-261	3h
CHS-6	9h	FBG-I-D	6h	HS-9050-05	10h	MWA-1	7h
CHS-7	9h	FBG-I-SQ	6h	HS-9050-32	10h	MWAP	7h
CHS-8	9h	FBT-1	6h	HS-9060-01	10h	PDF-161	2h
CP-258	2h	FBRK-2	3h	HS-9060-02	10h	PSA	6h
CR-060	8h	FBRK-3	3h	HS-9060-03	10h	SA-615	5h
CR-125	8h	FBR-A	1h	HS-9060-04	10h	SA-618	5h
CR-275	8h	FBR-B	1h	HS-9060-05	10h	SHF-50	1h
CR-300	8h	FBR-C	1h	HS-9060-22	10h	SHF-45	1h
CSPB-30	7h	FF-45	1h	HS-9060-24	10h	SMAF-261	3h
CSPB-50	7h	FF-50	1h	HS-9060-32	10h	SPB-30	7h
CSPB-80	7h	FPK-86	3h	HS-9060-35	10h	SPB-60	7h
CV-86	2h	FPK-161	3h	HS-9060-36	10h	SPB-80	7h
CV-2414	2h	FS-260	1h	HS-9060-37	10h	ST-386	2h
CV-8624	2h	GS-10-G	6h	HS-9070-01	10h	TB-215	6h
CVRL	2h	GS-10-PC	6h	HS-9070-02	10h	TL-1	8h
DBS-386	2h	HD-1	9h	HS-9070-03	10h	TL-2	8h
DCB-270	5h	HF-45	1h	HS-9070-04	10h	TL-3	8h
DCB-280	5h	HR-100	4h	HS-9070-05	10h		

FASTENERS

Product	Fastening Type
AF-260 & AF-261, AF-29 & AF-291, AF-29L & AF-291L	2 ea. 12-24 x 3/4" Flat Head Combo Screw
BTS-160, FB-225, EF-160, EF-161, EF-161-TG, EF-161-S, EF-634	2 ea. #8-32 x 1/2" FHMS
FF-45 & FF-50, FS-260, DBS-386, ST-386, CV-86, CV-8624, EF-86, LW-86, EL-86, SFF-50, HF-45, SHF-45	2 ea. #12-24 x 1/2" FHMS
EPT-1	2 ea. #10-24 x 1/2" FHMS
CV-2414, CVRL	2 ea. #10 x 1 1/2" FHSMS
BF-161, BF-178, BF-135, PDF-161	1 ea. #10-32 x 1 1/2" FHMS
TL-1, TL-3	2 ea. #12-24 x 1/2" FHSMS, 2 ea. #8-32 x 1/2" FHMS
TL-2	4 ea. #12-24 x 1/2" FHMS

FILLER PLATES



BTS-160-PC
T-strike with I60 cut out

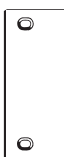

FF-45
FF-50
Frame hinge cut out



FS-260-PC
ANSI strike cut out



EPT-I
Fill holes left by electric power transfer



HS-060
16 (.060) Gauge Hinge shim



HS-050
16 (.060) Gauge Hinge shim



FBR-A

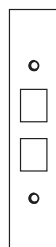

FBR-B



FBR-C

NUMBER	DIMENSIONS	MATERIAL
BTS-160	2 3/4" x 1 3/8"	Steel
EPT-I	9" x 1 1/4"	
FBR-A	3 7/8" x 1"	
FBR-B	5 7/8" x 1 1/4"	
FBR-C	3 7/8" x 1"	
FF-45	4 1/2" x 1 5/8"	
FF-50	5" x 1 5/8"	
FS-260	4 7/8" x 1 1/4"	
HS-050	4 1/2" x 1/2"	
HS-060	4 1/2" x 1 5/8"	
HS-080	4 1/2" x 1/2"	
HS-090	4 1/2" x 1 5/8"	

SHELF PACK: 10 Polybagged
FINISH: PC (Prime Coated)

FILLER PLATES



EF-86
LW-86
86 cut out



EF-160
160 cut out
EF-161
161 cut out



EF-634
Flush bolt cut out



FB-225
Flush bolt strike filler



HF-45
SHF-45
SHF-50
Door hinge cut out

NUMBER	DIMENSIONS	MATERIAL
EF-86	8" x 1 1/4" x 3/16"	Steel
EF-160	2 1/4" x 1"	
EF-161	2 1/4" x 1 1/8"	
EF-161-S	2 3/4" x 1 1/8"	
EF-161-TG	2 1/4" x 1 1/8"	
EF-634	6 3/4" x 1"	
FB-225	2 1/4" x 15/16"	
HF-45	4 1/2" x 1 3/4"	
LW-86	8" x 1 1/4" x 1/4"	
SHF-45	4 1/2" x 1 1/2"	
SHF-50	5" x 1 1/2"	

SHELF PACK: 10 Polybagged
FINISHES: (EF-86, EF-634, LW-86, FB-225, HF-45, SHF-45, EF-161-S, EF-161-TG, SHF-50) PC (Prime Coated), (EF-160, EF-161) BP (Brass Plated), CP (Chrome Plated), PC (Prime Coated),

CONVERSION PLATES



CV-86
Converts 86
cut out to I61



CV-2414
Converts Sargent's
Integra locks



CV-8624
Converts 86
cut out to (2) I61

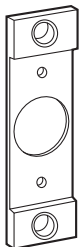

CVRL
Converts 3 3/8" x 1"
roller latch to a
standard latch prep



DBS-386
Deadbolt strike
for 86 cut out
Use with pair of
doors



EL-86
Converts mortise
to electronic
lock



ST-386-PC
Use with pair of
86 cut out doors
Apply ANSI strike
over Reversible

NUMBER	DIMENSIONS	MATERIAL
CV-86	8" x 1 1/4"	Steel
CV-2414	4 1/4" x 1 1/4"	Steel
CV-8624	8" x 1 1/4"	Steel
CVRL	3 3/8" x 1"	Steel
DBS-386	8" x 1 1/4"	Aluminum
EL-86	8" x 1 1/4"	Steel
ST-386-PC	8" x 1 1/4"	Aluminum

SHELF PACK: 10 Polybagged
FINISHES: (CV-86, CVRL, CV-8624, DBS-386, EL-86
 ST-386) **PC (Prime Coated)**
 (CV-2414) **SL (Silver Coated)**

HOLE FILLER PLATES

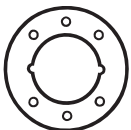

AR-335
Allows for use of levers
on 1 3/8" door

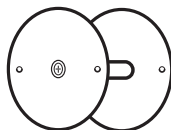

BF-135
Covers up to 3 3/4" hole

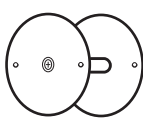

BF-161
Covers up to 2 1/8" hole

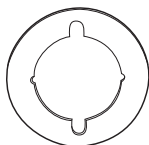

AR-9K
Allows for use of levers
on 1 3/8" door

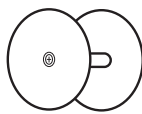

BF-178
Covers up to 1 1/2" hole



PDF-161
Covers up to 2 1/8" hole
under rim panic device

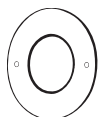

CP-258
2 5/8" cylinder plate -
indents at 3 & 9 o'clock
prevents collar from
shifting on wood or metal

NUMBER	DIMENSIONS	MATERIAL
AR-335	3 1/2" Diameter	Aluminum
AR-9K	3 1/2" Diameter	Aluminum
BF-135	3 3/4" Diameter	Steel
BF-161	2 5/8" Diameter	
BF-178	1 7/8" Diameter	
CP-258	2 5/8" Diameter	
PDF-161	2 1/8" Hole	

SHELF PACK: 10 Polybagged
FEATURES: •(CP-258): Can be used with Rim or Mortise
 Cylinders
 •(AR-335): Use with Schlage, Yale, Arrow,
 Corbin-Russwin, Cal-Royal, Hager
 •(AR-9K): Use with Sargent, Best, Marks
FINISHES: (AR-335, AR-9K) 605, 613, 630
 (BF-135, BF-161, BF-178, CP-258)
BP (Brass Plated), CP (Chrome Plated),
PC (Prime Coated), SL (Silver Coated),
 (PDF-161) **PC (Prime Coated)**

LATCH SPACER PLATE



LSP-1

NUMBER	DIMENSIONS	MATERIAL
LSP-1	2 1/4" x 1 1/8"	Steel

SHELF PACK: 50 Polybagged
FEATURES: Works with 1" latch face plates in a 1 1/8" prep
FINISHES: Black - Plastic

ELECTRIC STRIKE FILLER plates for selected Folger Adams, Von Duprin, and Rofu numbers



AF-260

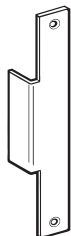

AF-29



AF-29L



MAF-261



AF-261



AF-291



AF-291L



SMAF-261

NUMBER	DIMENSIONS	MATERIAL
AF-29	9" x 1 3/8"	Steel
AF-29L	9" x 1 3/8"	
AF-260	4 7/8" x 1 1/4"	
AF-261	4 7/8" x 1 1/4"	
AF-291	9" x 1 3/8"	
AF-291L	9" x 1 3/8"	
MAF-261	4 7/8" x 1 1/4"	
SMAF-261	4 7/8" x 1 1/4"	

SHELF PACK: 10 Polybagged
GAUGE: 13 (.095) Steel
FEATURES: • Electric Strike Filler
 • Fits selected Folger Adams, Von Duprin, and Rofu numbers
 • (MAF-261, SMAF-261): Works with Schlage Mortise Locks and all other Mortise Locks
FINISHES: DU (Duro Coated), SL (Silver Coated)

FILLER PLATE KITS

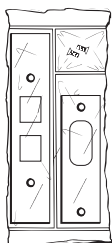

FBRK-2
Flush bolt reinforcement kit

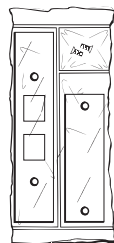

FBRK-3
Blank Flush Bolt reinforcement kit

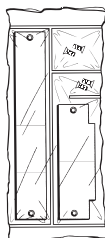

FPK-86
For 86 cut out



FPK-161
For 161 cut out

NUMBER	CONTENTS	MATERIAL
FBRK-2	Strike/Reinforcement	Steel
FBRK-3	Blank/Reinforcement	
FPK-86	EF-86/FS-260	
FPK-161	BF-161/EF-161 FS-260	

SHELF PACK: 10 Polybagged
FINISHES: PC (Prime Coated)



HINGE REINFORCEMENTS

NUMBER	DESCRIPTION	USED WITH	SIZE	OFFSET	HINGE WEIGHT	GAUGE	MATERIAL
HR-100	3 1/2" Hinge Reinforcement	Door/Frame	1 1/16" x 8 1/2"	1/16"	.120	10	Steel
HR-110	4" Hinge Reinforcement	Door/Frame	1 1/4" x 10"	3/32"	.124	7	
HR-120	4 1/2" Hinge Reinforcement	Door/Frame	1 1/4" x 10"	3/32"	.134	7	
HR-130	4 1/2" Hinge Reinforcement	Frames	1 1/2" x 10"	3/32"	.134	7	
HR-140	4 1/2" Hinge Reinforcement	Door/Frame	1 1/4" x 10"	1/8"	.190	7	
HR-150	4 1/2" Hinge Reinforcement	Frames	1 1/2" x 10"	1/8"	.190	7	
HR-160	5" Hinge Reinforcement	Door/Frame	1 1/4" x 10"	3/32"	.146	7	
HR-170	5" Hinge Reinforcement	Frames	1 1/2" x 10"	3/32"	.146	7	
HR-180	5" Hinge Reinforcement	Door/Frame	1 1/4" x 10"	1/8"	.190	7	
HR-190	5" Hinge Reinforcement	Frames	1 1/2" x 10"	1/8"	.190	7	
HR-200-4 1/2	4 1/2" Blank Hinge Reinforcement	Door/Frame	1 1/4" x 10"	3/32"	-	7	
HR-210-5	5" Blank Hinge Reinforcement	Door/Frame	1 1/4" x 10"	3/32"	-	7	
HR-215-4 1/2	4 1/2" Flat Hinge Reinforcement	Doors	1 1/4" x 10"	-	-	7	
HR-216-5	5" Flat Hinge Reinforcement	Doors	1 1/4" x 10"	-	-	7	
HR-217	6" Hinge Reinforcement	Door/Frame	1 1/4" x 12"	7/64"	.160	7	
HR-218	6" Hinge Reinforcement	Door/Frame	1 1/4" x 12"	9/64"	.203	7	

SHELF PACK: 25
FINISH: Raw Steel

Box Pack

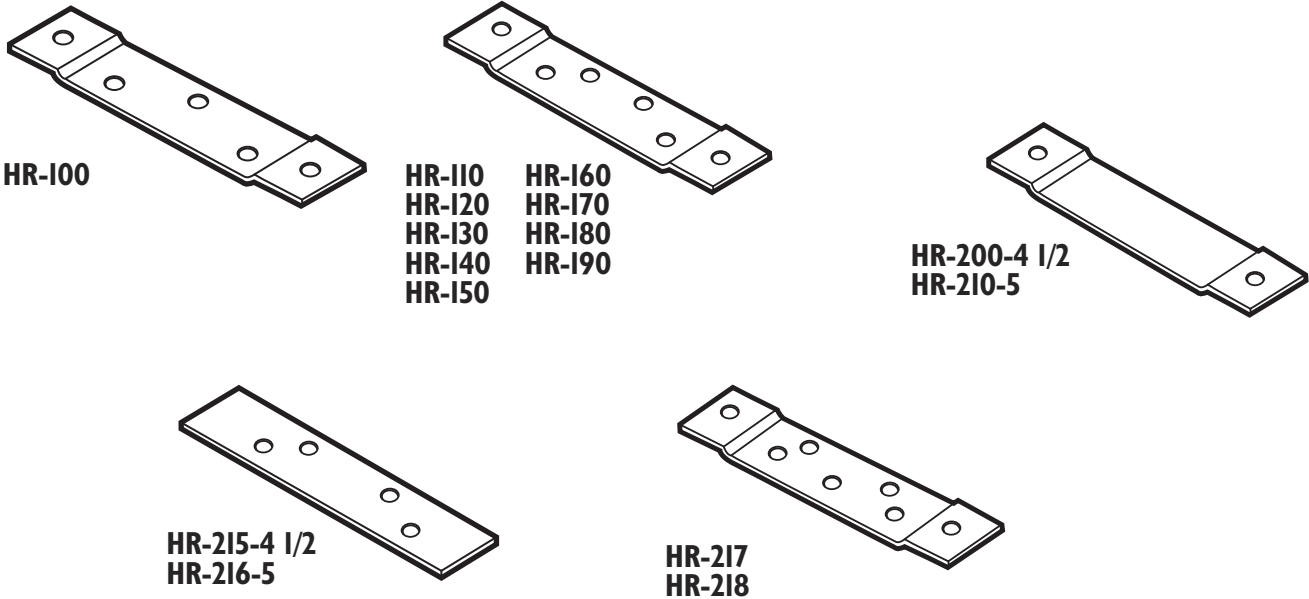

HINGE REINFORCEMENTS

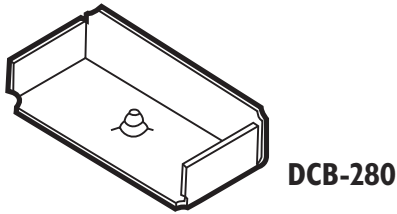
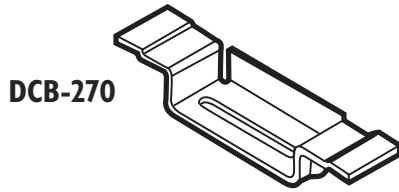

NUMBER	DESCRIPTION	DEPTH	GAUGE	MATERIAL
DCB-270	Dust Cover Box/Frame Hinge	3/4"	25	Steel
DCB-280	Dust Cover Box/Frame Hinge	5/16"	25	

SHELF PACK: 50
FINISH: Raw Steel

Box Pack

STRIKE REINFORCEMENTS

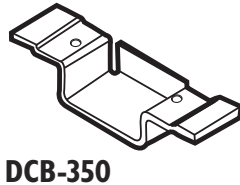
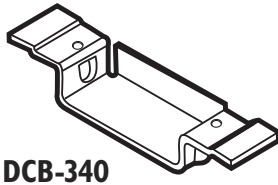

NUMBER	DESCRIPTION	MATERIAL
DCB-340	4 7/8" Strike w/Dust Cover	Steel
DCB-350	2 3/4" Strike w/Dust Cover	

SHELF PACK: 50
FINISH: Raw Steel

Box Pack

STRAP ANCHORS

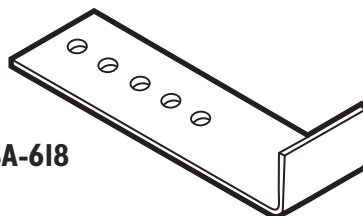
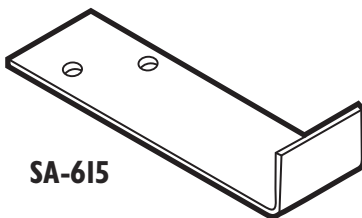

NUMBER	DESCRIPTION	SIZE	GAUGE	MATERIAL
SA-615	Strap Anchor	1" x 4 1/2" x 1 1/4" W	16	Steel
SA-618	Strap Anchor	1" x 5" x 1" W	18	

SHELF PACK: 50
FINISH: Raw Steel

Box Pack

TABS & GUIDES

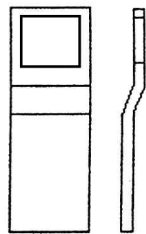
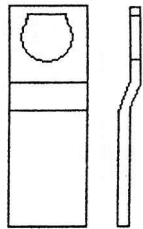
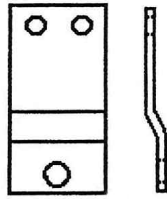
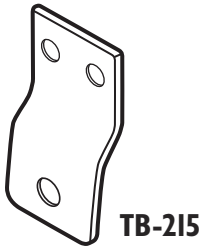

NUMBER	DIMENSIONS		OFFSET	MATERIAL
	LENGTH	WIDTH		
TB-215	1"	1 1/2"	1/8"	Steel
FBT-I	2 1/2"	7/8"	1/8"	
FBG-I-D	2 1/2"	7/8"	5/16"	
FBG-I-SQ	3 1/4"	1 3/4"	5/16"	

SHELF PACK: 50
FINISH: Raw Steel

Box Pack

GLAZING BEAD

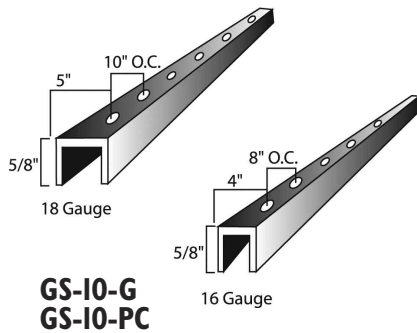

NUMBER	SIZE	GAUGE	MATERIAL
GS-10-G	5/8" x 5/8" x 5/8"	18	Galvanized
GS-10-PC	5/8" x 5/8" x 5/8"	16	Steel

SHELF PACK: 50

PIPE SLEEVE ANCHORS

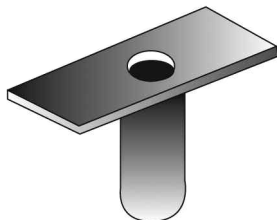

NUMBER	SIZES	GAUGE	MATERIAL
PSA	4 3/4", 5 3/4", 6 3/4", 7 3/4", 8 1/4", 8 3/4"	11	Steel

SHELF PACK: 50

Box Pack

HOW TO ORDER:
Part # x Size, i.e.: PSA-5 3/4

SPREADER BARS

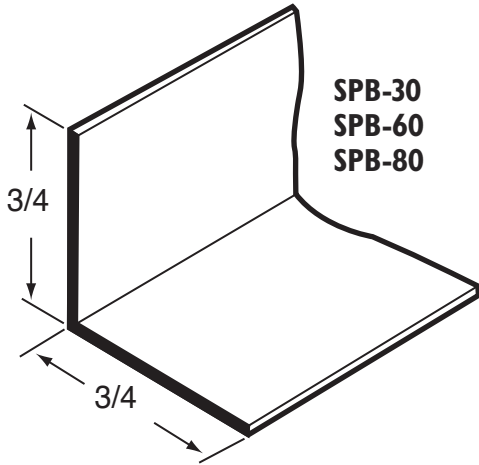

NUMBER	SIZE	LENGTH	GAUGE	MATERIAL
SPB-30	3/4" x 3/4"	36"	16	Steel
SPB-60	3/4" x 3/4"	72"	16	
SPB-80	3/4" x 3/4"	96"	16	
CSPB-30	3/4" x 3/4" x 3/4"	36"	16	
CSPB-50	3/4" x 3/4" x 3/4"	60"	16	
CSPB-80	3/4" x 3/4" x 3/4"	96"	16	

SHELF PACK: 50
FINISH: Raw Steel

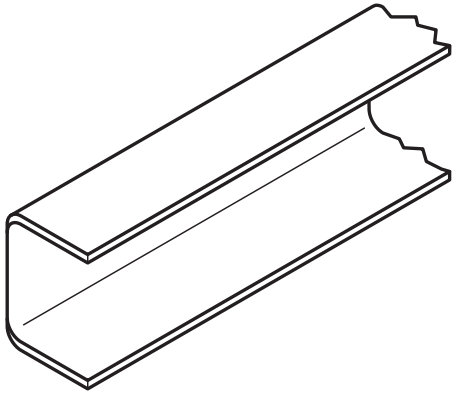

METAL-WOOD STUD COMBO ANCHOR

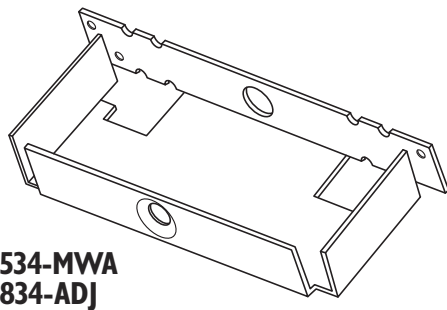

NUMBER	DESCRIPTION	MATERIAL
534-MWA	5 3/4"	Steel
834-ADJ	Adjust 5 3/4" to 8 3/4"	
MWAP	Anchor Plug	
MWA-I	Wire Anchor	

SHELF PACK: (534-MWA, 834-ADJ): 50 **Box Pack**
(MWAP): 100 **Box Pack**
(MWA-I): 520 **Box Pack**

FEATURES: (MWAP): Designed to fill the holes created when using 534-MWA

FINISH: Raw Steel
(MWAP): Black





REINFORCEMENT PLATES

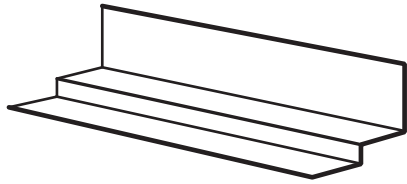

CR-275
Closer
Reinforcement

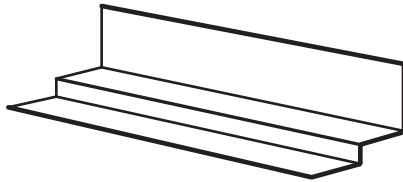
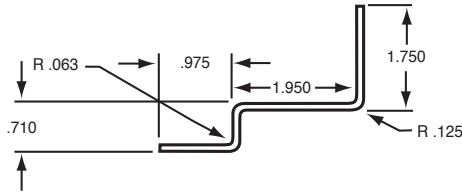

CR-300
For use with
Parallel arm
closers

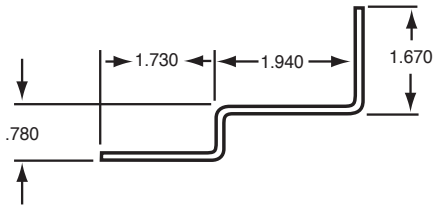

NUMBER	DIMENSIONS	GAUGE	MATERIAL
CR-060	12" x 1 3/4"	16	Steel
CR-125	12" x 1 3/4"	10	
CR-275	14" x 4 1/8"	12	
CR-300	14" x 4 1/8"	12	

SHELF PACK: 10
FINISH: Raw Steel



CR-060
16 (.060) Gauge
Closer Reinforcement



CR-125
10 (.125) Gauge
Closer Reinforcement

TEMPORARY LOCKS

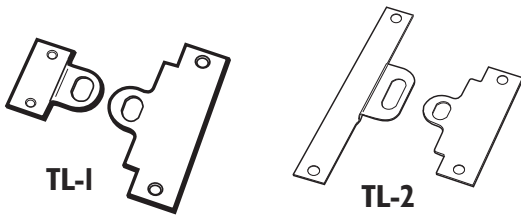

TL-1

TL-2

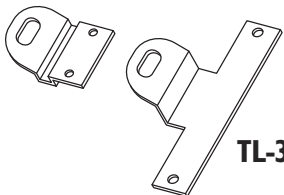

TL-3

NUMBER	DIMENSIONS		MATERIAL
	STRIKE	LATCH	
TL-1	4 7/8" x 1 1/4"	2 1/4" x 1 1/8"	Steel
TL-2	4 7/8" x 1 1/4"	8" x 1 1/4"	
TL-3	4 7/8" x 1 1/4"	2 1/4" x 1 1/8"	

SHELF PACK: 10 Polybagged
FEATURES: • (TL-1) Fits 2 1/4" latch preps and fits 4 7/8" strike prep
• (TL-2) Fits 86 edge preps and fits 4 7/8" strike prep
• (TL-3) Works with in swing doors
FINISH: Prime Coated

TITLE 24 SIGNS



**CHS-1
CHS-6**



**CHS-2
CHS-7**



**CHS-3
CHS-8**



CHS-4



CHS-5



HS-9070-46



HS-9070-47



HS-9070-48

Sign Size 1 3/4" x 6"

NUMBER	DESCRIPTION	COLOR
CHS-1	Men	Blue
CHS-2	Women	Blue
CHS-3	Restroom	Blue
CHS-4	Boys	Blue
CHS-5	Girls	Blue
CHS-6	Men	Black
CHS-7	Women	Black
CHS-8	Restroom	Black
HS-9070-46	Men	Blue
HS-9070-47	Women	Blue
HS-9070-48	Restroom	Blue

SHELF PACK: 10 Polybagged
FEATURES: • Raised white lettering
 • Braille translation on sign

DECALS



HD-1

NUMBER	DECAL COLOR	DIMENSIONS
DD-1/DD-5	Black on Clear	1 1/2" x 24"
DD-2/DD-6	White on Black	1 1/2" x 24"
DD-3/DD-7	Black on Clear	1 1/2" x 24"
DD-4/DD-8	White on Black	1 1/2" x 24"
HD-1	White on Blue	4" x 4"

Polybagged

DD-1/DD-2 THIS DOOR TO REMAIN UNLOCKED DURING BUSINESS HOURS

DD-3/DD-4 THESE DOORS TO REMAIN UNLOCKED DURING BUSINESS HOURS

DD-5/DD-6 THIS DOOR TO REMAIN UNLOCKED WHILE BUILDING IS OCCUPIED

DD-7/DD-8 THESE DOORS TO REMAIN UNLOCKED WHILE BUILDING IS OCCUPIED



A.D.A. SIGNS



HS-9050-01
HS-9060-01
HS-9070-01
HS-9090-01



HS-9060-02
HS-9070-02



HS-9060-03
HS-9070-03



HS-9070-07



HS-9060-04
HS-9070-04



HS-9050-05
HS-9060-05
HS-9070-05
HS-9090-05



HS-9060-22
HS-9070-22



HS-9070-08



HS-9070-24



HS-9070-27



HS-9050-32
HS-9060-32
HS-9070-32
HS-9090-32



HS-9080-02
HS-9070-06



HS-9060-35
HS-9070-35



HS-9060-36



HS-9070-34

BROWN SIGNS	NUMBER	DESCRIPTION
	HS-9060-01	Men's/Handicap
	HS-9060-02	Men's Room
	HS-9060-03	Restrooms
	HS-9060-04	Women's Room
	HS-9060-05	Women's/Handicap
	HS-9060-22	No Smoking
	HS-9060-32	Women/Men/Handicap
	HS-9060-35	Exit
	HS-9060-36	Arrow Diagonal
HS-9080-02	Handicap Accessible	

(6"x6")
(6"x6")

BLUE SIGNS	NUMBER	DESCRIPTION
	HS-9070-01	Men's/Handicap
	HS-9070-02	Men's room
	HS-9070-03	Restrooms
	HS-9070-04	Women's Room
	HS-9070-05	Women's/Handicap
	HS-9070-06	Handicap Accessible
	HS-9070-07	Boy's/Handicap
	HS-9070-08	Girl's/Handicap
	HS-9070-22	No Smoking
	HS-9070-24	Stairs
	HS-9070-27	Telephone
	HS-9070-32	Women/Men/Handicap
	HS-9070-34	Exit Route
	HS-9070-35	Exit

(6"x6")
(6"x6")

TAN SIGNS	NUMBER	DESCRIPTION
	HS-9050-01	Men's/Handicap
	HS-9050-05	Women's/Handicap
HS-9050-32	Women/Men/Handicap	

BLACK SIGNS	NUMBER	DESCRIPTION
	HS-9090-01	Men's/Handicap
	HS-9090-05	Women's/Handicap
HS-9090-32	Women/Men/Handicap	

- SHELF PACK: 10** Polybagged
FEATURES:
- Sign Size - 6" x 9"
 - Raised white lettering
 - Braille translation on sign
 - A.D.A. compliant